



ATLONA
Connecting Technology

Product Catalog
2016 Issue 1

Table of Contents

Atlona Advantage

5

What's New

6

Solutions and Applications

10

Software

28

Switchers

30

Distribution Amplifiers

46

Extenders

54

Converters and Scalers

70

Audio

76

Test Equipment

81

Cable and Adapters

84



Atlona Advantage

Atlona offers the industry's best services, support and warranties, so you can specify, purchase, and install with confidence.

Atlona 10 Year Limited Warranty

Atlona will repair or replace defective electronics or hardware for up to ten years from date of purchase.

Atlona **Next Day** Advance Product Replacement

Atlona offers US customers free next-day shipment for up to one year if a product is determined to be defective.

Atlona 30 Day Customer Satisfaction

Atlona offers a full refund within 30 days of purchase if a product is returned.

Atlona 7 Day/Week Tech Support

Atlona offers technical support from trained and certified experts, all week, year-round.

Atlona Academy

Atlona shares industry expertise via webinars, online training, team training, and more.

Atlona

Since 2003, Atlona has been a global leader and provider of innovative AV distribution products. We provide a single platform for transporting digital signals. Atlona technologies are the foundation for device connectivity and content sharing within corporate and residential spaces alike. Atlona's integrated solutions drive and deliver content further, and at the highest quality, while offering a simple and reliable user experience.



What's New

We're always looking for ways to innovate and improve.



4K/UHD 5 Input HDMI Switcher with Two HDBaseT Inputs and Mirrored HDMI/HDBaseT Outputs

The Atlona AT-UHD-SW-5000ED is a 5x1 switcher with two HDBaseT™ inputs, three HDMI inputs, mirrored HDMI and HDBaseT outputs, balanced audio outputs, automatic input selection, and advanced display control capability. The HDBaseT inputs match perfectly with the HDVS-200-TX modules to enable VGA and HDMI sources to be easily integrated into a system.

(See page 39 for more info.)

[model no. AT-UHD-SW-5000ED]



Soft Codec Conferencing System

The Atlona AT-UHD-HDVS-300-KIT provides AV switching, USB and HDMI extension, plus system control for huddle spaces using PC-based conferencing codecs such as Skype™, WebEx™ and GoToMeeting™. The transmitter and receiver kit offers five video inputs shared between both devices for HDMI, DisplayPort, and analog video signals.

(See page 62 for more info.)

[model no. AT-UHD-HDVS-300-KIT]



4K/UHD, HDMI Over 100M HDBaseT TX/RX with Ethernet, Control and PoE, and Return Optical Audio

The Atlona AT-UHD-EX-100CEA-KIT is a premium HDBaseT extender pair for residential systems that require audio from the TV to be amplified by an AVR near the set top box located at some distance from the TV. Return audio may be any audio signal including Dolby or DTS up to 5.1 (based on limitations of optical audio standard).

(See page 56 for more info.)

[model no. AT-UHD-EX-100CEA-KIT]



Two-Input Wall Plate Switcher for HDMI and VGA Sources

The AT-HDVS-200-TX-WP is a 2x1 switcher for HDMI and VGA inputs with HDBaseT output. It features a US, two-gang, Decora form factor with one HDMI and one VGA input with an always-on 3.5mm audio connector.

(See page 61 for more info.)

[model no. AT-HDVS-200-TX-WP]



4K/UHD HDMI Over 100M HDBaseT Transmitter with Ethernet, Control, and PoE

The Atlona AT-UHD-EX-100CE-TX is an HDBaseT™ transmitter for HDMI transmission up to 328 feet (100 meters) over category cable with Ethernet pass through, plus RS-232 and IR control. Designed to work with HDBaseT inputs on switchers and projectors, this extender transmits video signals up to 4K/UHD @ 60Hz with embedded multi-channel audio. See page 56 for more info.)

[model no. AT-UHD-EX-100CE-TX]



4K/UHD 4-Output HDMI to HDBaseT Distribution Amplifier

The Atlona AT-UHD-CAT-4 is a 4K/UHD HDMI to HDBaseT™ distribution amplifier featuring pass-through HDMI input connections, four HDBaseT outputs and display control capability. Each output transmits AV and control signals up to 230 ft. (70 m) @ 1080p and 130 ft. (40 m) @ 4K/UHD.

(See page 49 for more info.)

[model no. AT-UHD-CAT-4]



4K/UHD, 6-Input Multi-Format Switcher with HDBaseT Inputs, Mirrored HDMI and HDBaseT Outputs

The Atlona AT-UHD-CLSO-612ED is an advanced six-input, multi-format switcher with 4K scaling, Ethernet-enabled HDBaseT™ and PoE capabilities. It simplifies classroom and small office system integration by providing two HDBaseT inputs, two HDMI inputs, two multi-function analog inputs, plus mirrored HDBaseT and HDMI outputs.

(See page 36 for more info.)

[model no. AT-UHD-CLSO-612ED]



4K/UHD 8-Output HDMI to HDBaseT Distribution Amplifier

The Atlona AT-UHD-CAT-8 is a 4K/UHD HDMI to HDBaseT™ distribution amplifier featuring pass-through HDMI input connections, eight, HDBaseT outputs and display control capability. Each output transmits AV and control signals up to 230 ft. (70 m) @ 1080p and 130 ft. (40 m) @ 4K/UHD.

(See page 49 for more info.)

[model no. AT-UHD-CAT-8]

Solutions

We design solutions with the system in mind. We're always looking for new ways to resolve specific challenges for unique installations.



Huddle

Small meeting spaces and small budgets don't mean you have to settle for inferior AV systems. The AT-HD-SC-500 packs automatic input selection, automatic display control scaling, and audio routing into one compact package.



Meeting

An ideal AV system for small spaces, the HDVS-200 Series includes both a compact 3x1 switcher and 2x1 wall plate switcher, both with Advanced Automatic System Control (AASC) and HDBaseT™ outputs plus the AT-HDVS-200-RX scaler.



Teleconferencing

Improve PC-based teleconferences using Skype™ or GoToMeeting™ with the Atlona Soft Codec Conferencing System. HDMI switching and extension coupled with USB inputs for microphones and webcams help your AV systems make a better impression.



Small Conference

HDVS transmitters and the SW-5000ED 5-input switcher with HDBaseT make a powerful conference room solution for remote inputs and extended-distance outputs. AASC and the Atlona Management System simply system set up and operation.



Conference

The AT-UHD-CLSO-612ED multi-format switcher is perfect when used with HDVS transmitters in conference rooms with multiple digital and analog sources in multiple locations .



Divisible

The AT-UHD-CLSO-824 is the centerpiece of complex AV systems. An 8x2 presentation matrix with flexible configuration capabilities allow for support of up to four, 4K/UHD displays.



Whole Home

Simplify your AV system designs by sharing AV sources throughout the home using the UHD PRO3 Series matrix switcher Series. Includes built-in extension technology for 4K/UHD signal distribution.



Retail

High end retail and entertainment spaces demand ultra-high definition signal transmission. Atlona's UHD-CAT Series carries 4K/ UHD signals with display control throughout the venue.

Atlona Huddle Room Solution

Small meeting spaces and small budgets don't mean you have to settle for inferior AV systems. The AT-HD-SC-500 packs automatic input selection, automatic display control scaling, and audio routing into one compact package.

Huddleroom Solution 1

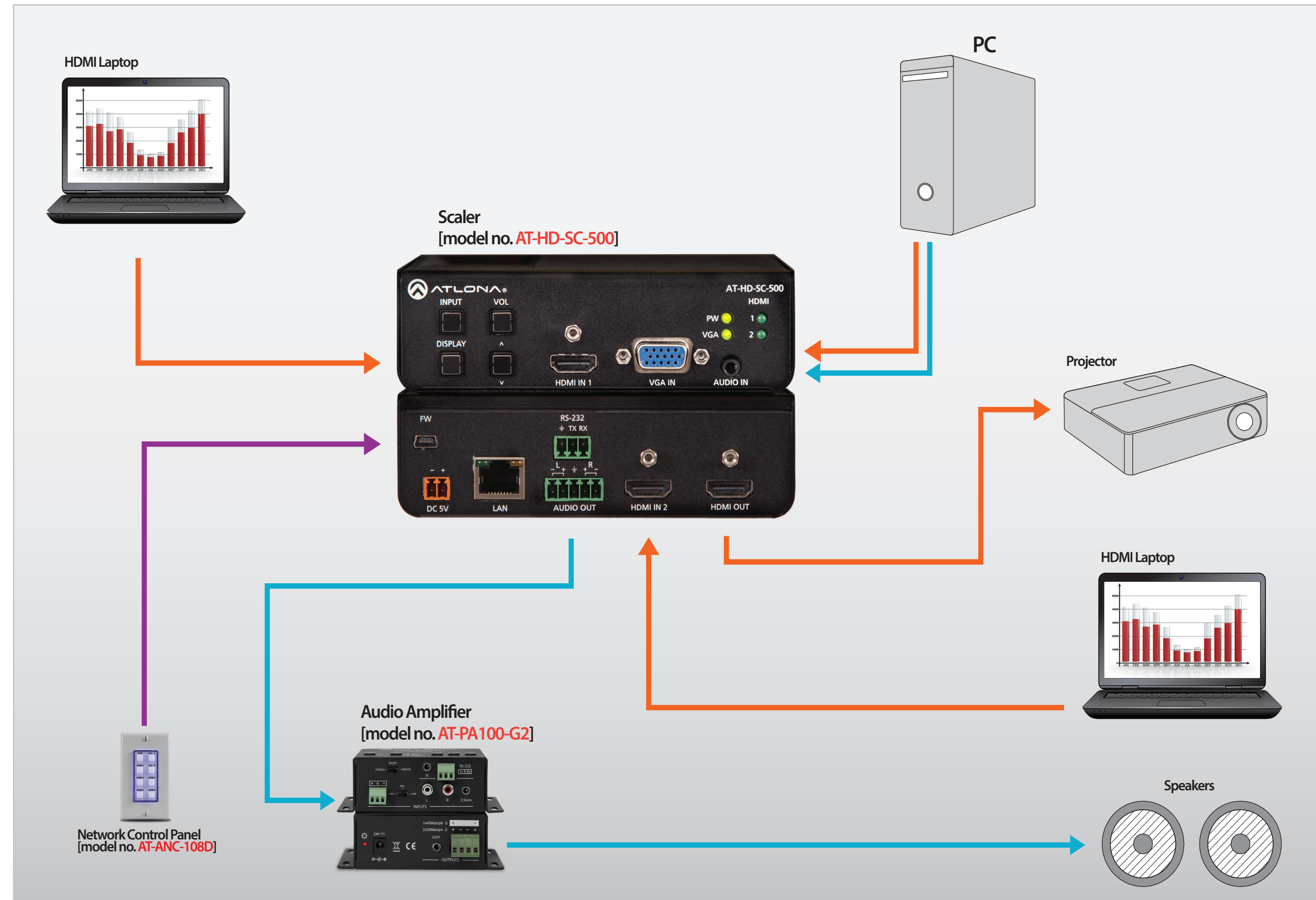

- Video
- Audio
- HDBaseT
- Control

Atlona Meeting Room Solution

An ideal AV system for small spaces, the HDVS-200 Series includes both a compact 3x1 switcher and 2x1 wall plate switcher, both with Advanced Automatic System Control (AASC) and HDBaseT™ outputs plus the AT-HDVS-200-RX scaler.

Huddle Room Table

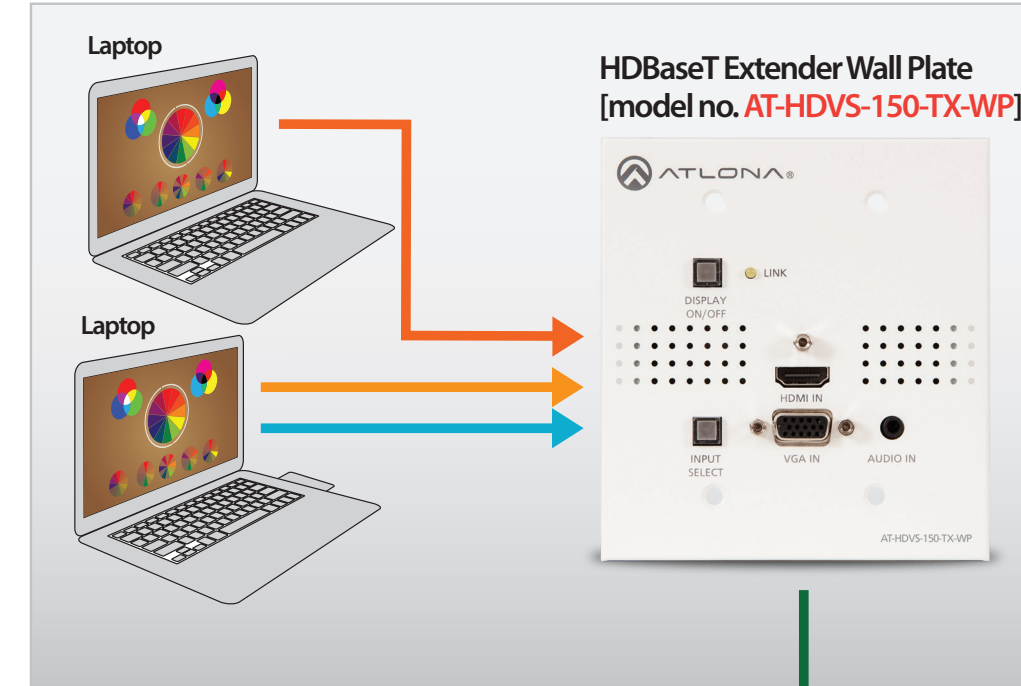

or

Huddle Room Table

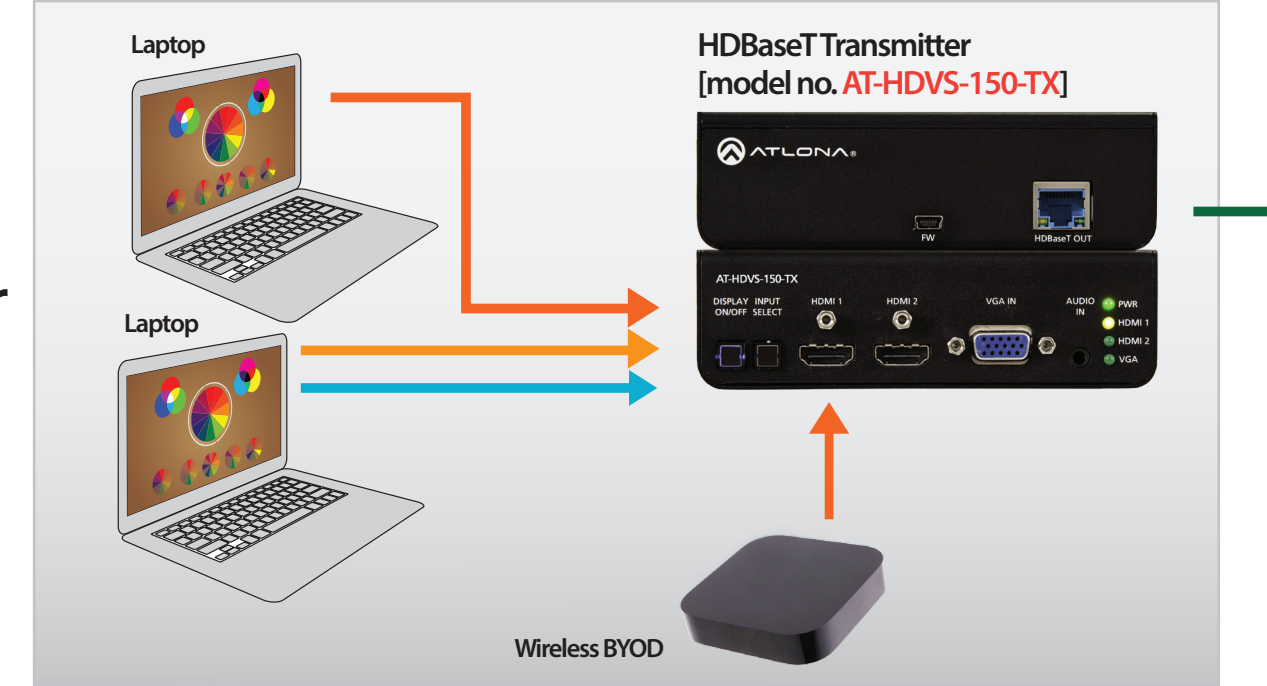

Display Area

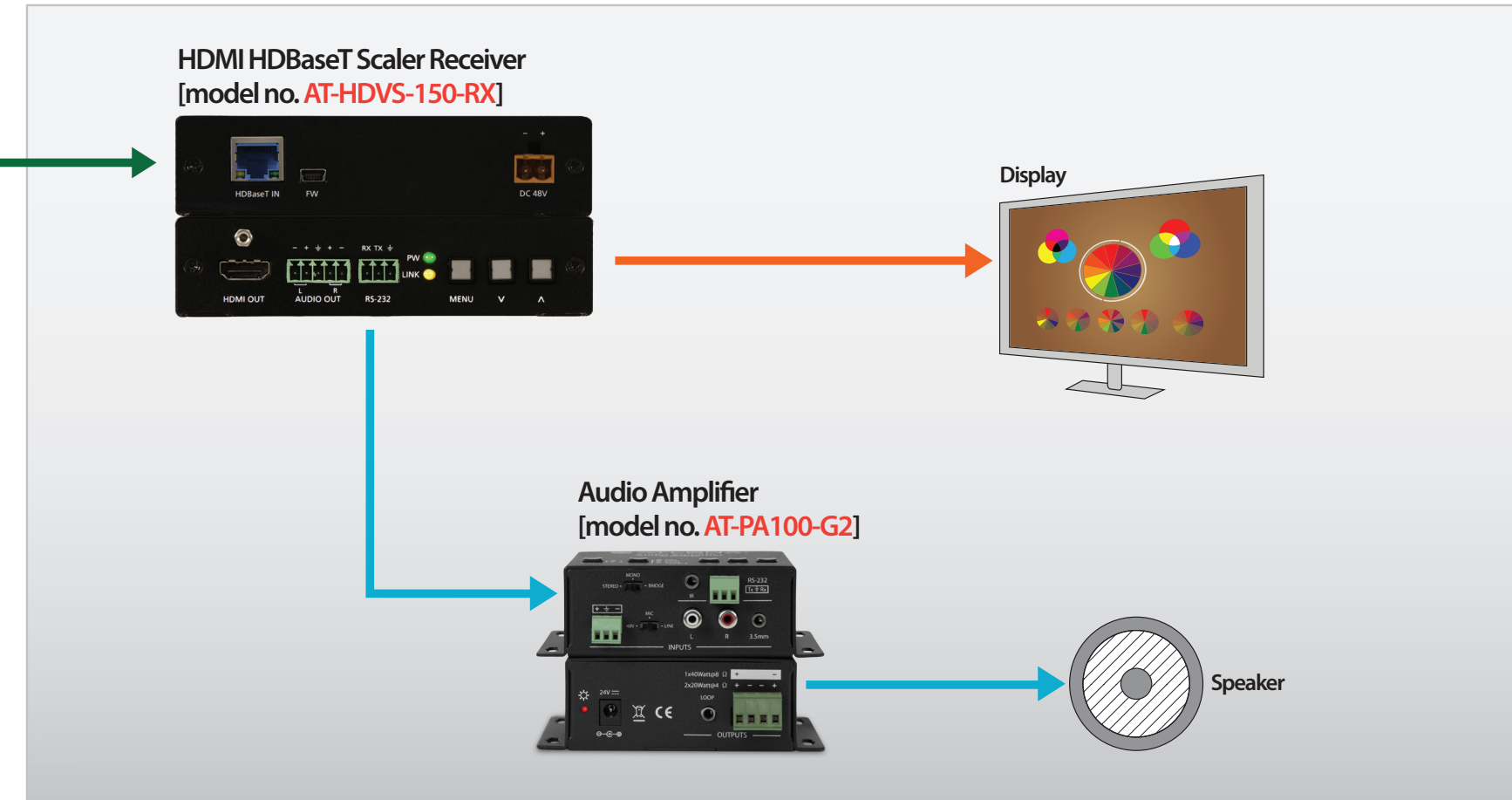

- Analog Video, VGA
- HDMI
- Audio
- HDBaseT
- Control

Atlona Teleconferencing Solution

Improve PC-based teleconferences using Skype™ or GoToMeeting™ with the Atlona Soft Codec Conferencing System. HDMI switching and extension coupled with USB inputs for microphones and webcams help your AV systems make a better impression.

Huddle Room Table

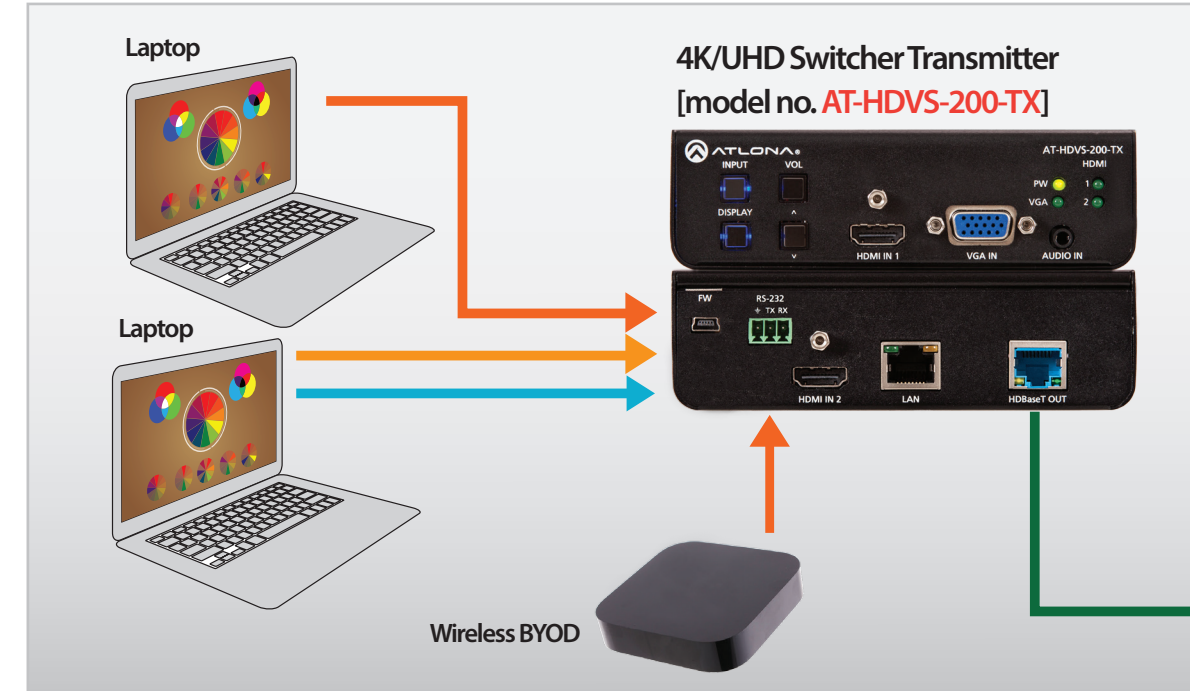

Huddle Room Table

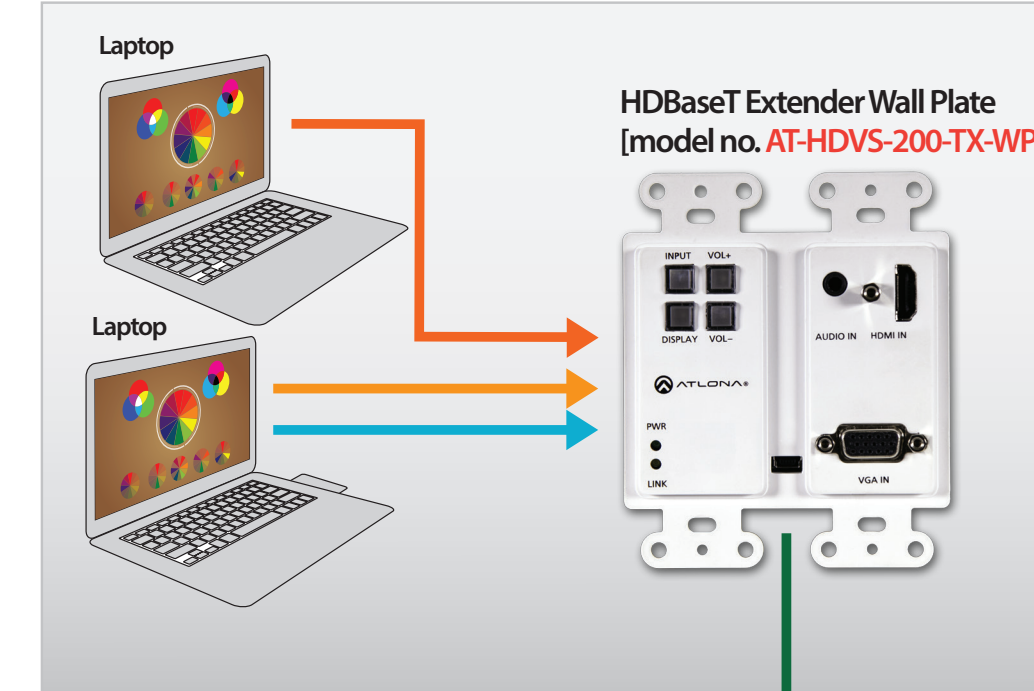

or

Display Area

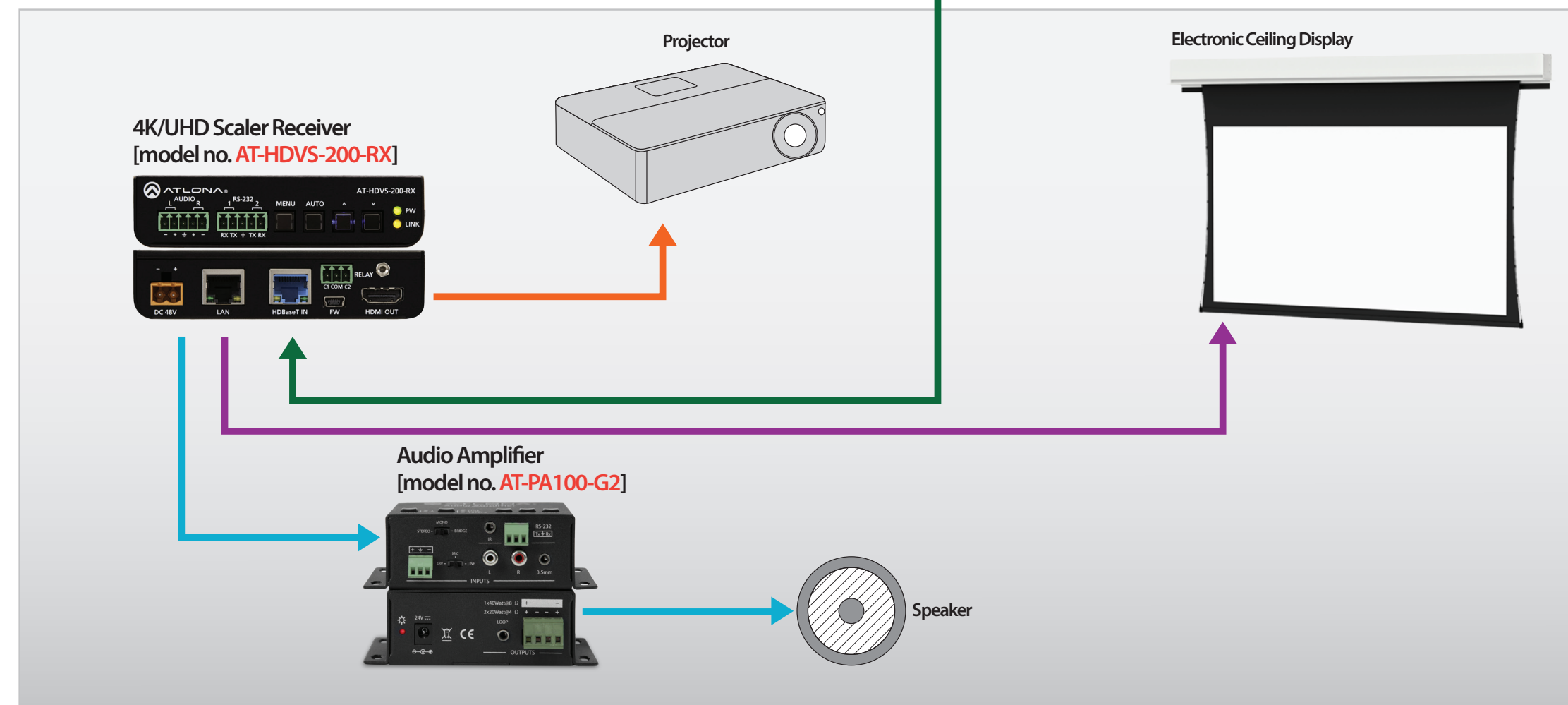

- Analog Video, VGA
- HDMI
- Audio
- HDBaseT
- Control

Atlona Small Conference Room Solution

HDVS transmitters and the SW-5000ED 5-input switcher with HDBaseT make a powerful conference room solution for remote inputs and extended-distance outputs. AASC and the Atlona Management System simply system set up and operation.

Lectern

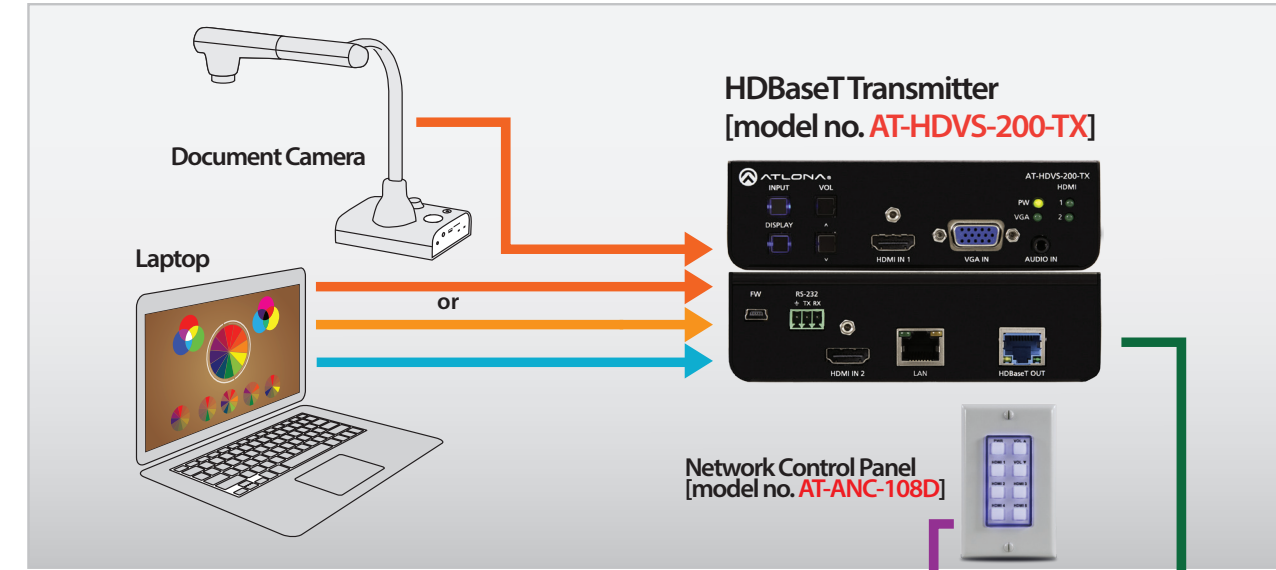

Conference Table

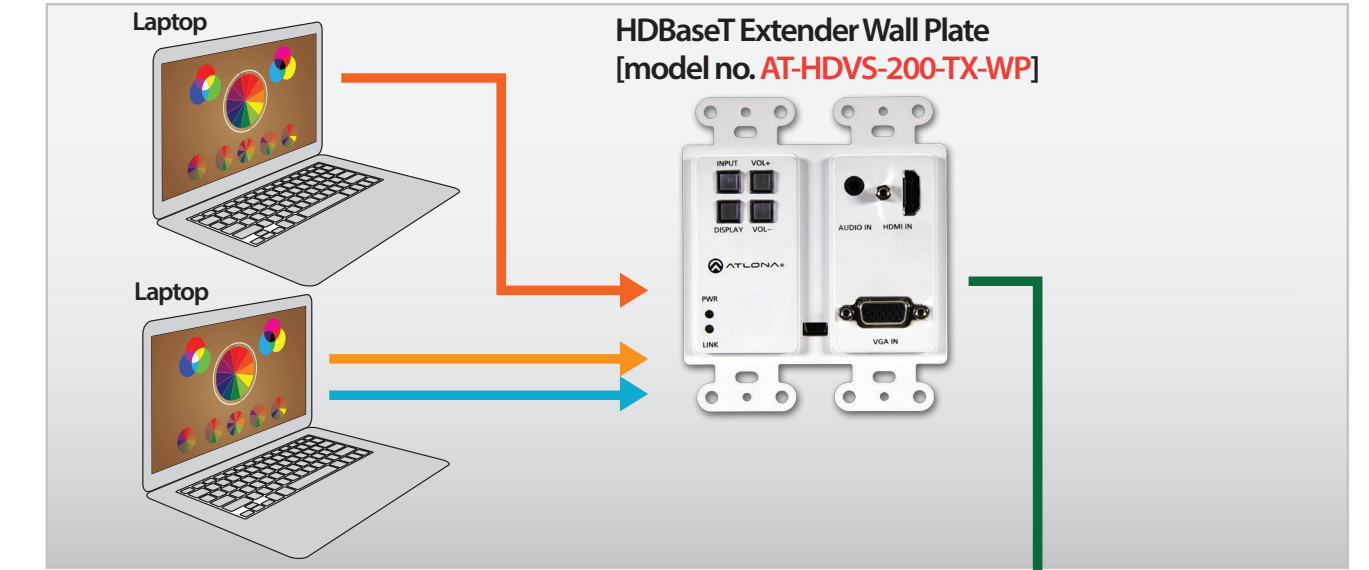

Equipment Rack

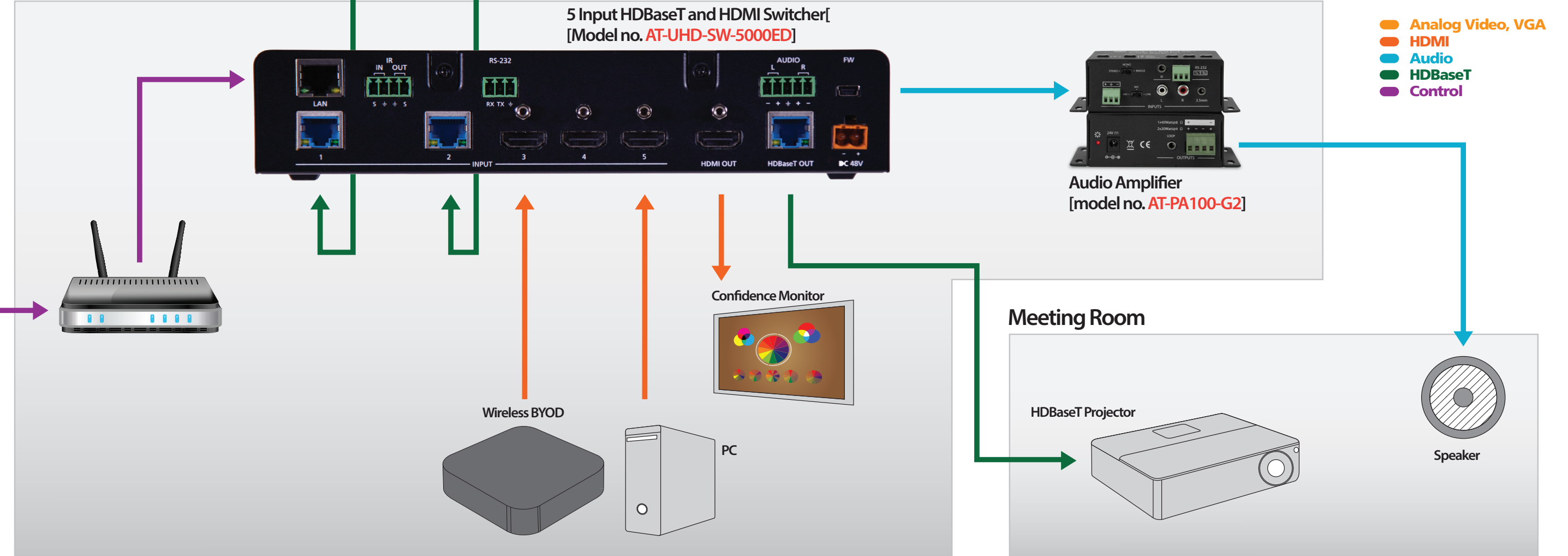

Atlona Conference Room Solution

The AT-UHD-CLSO-612ED multi-format switcher is perfect when used with HDVS transmitters in conference rooms with multiple digital and analog sources in multiple locations.

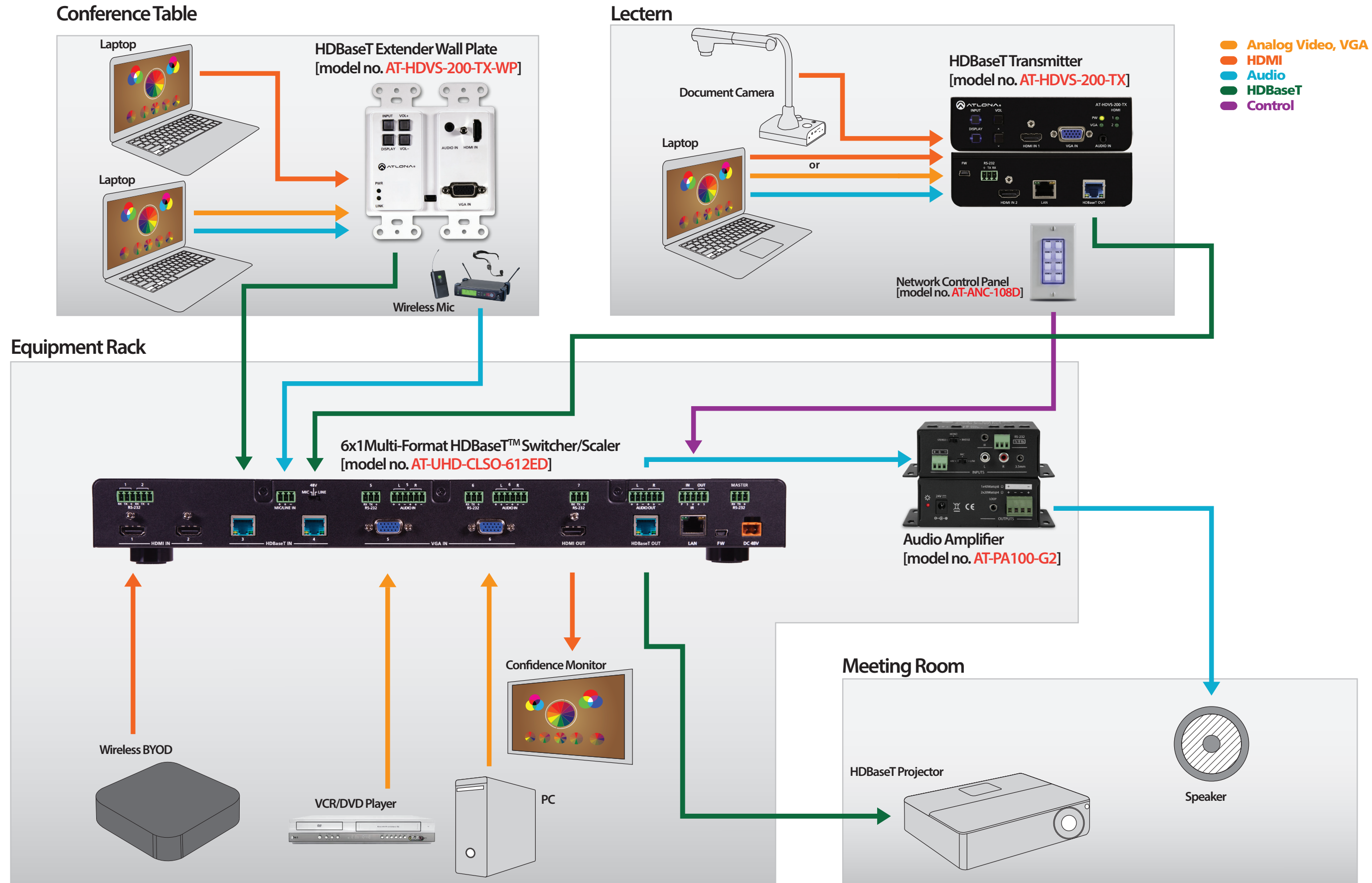



Atlona Divisible Room Solution

The AT-UHD-CLSO-824 is the centerpiece of complex AV systems. An 8x2 presentation matrix with flexible configuration capabilities allow for support of up to four, 4K/UHD displays.

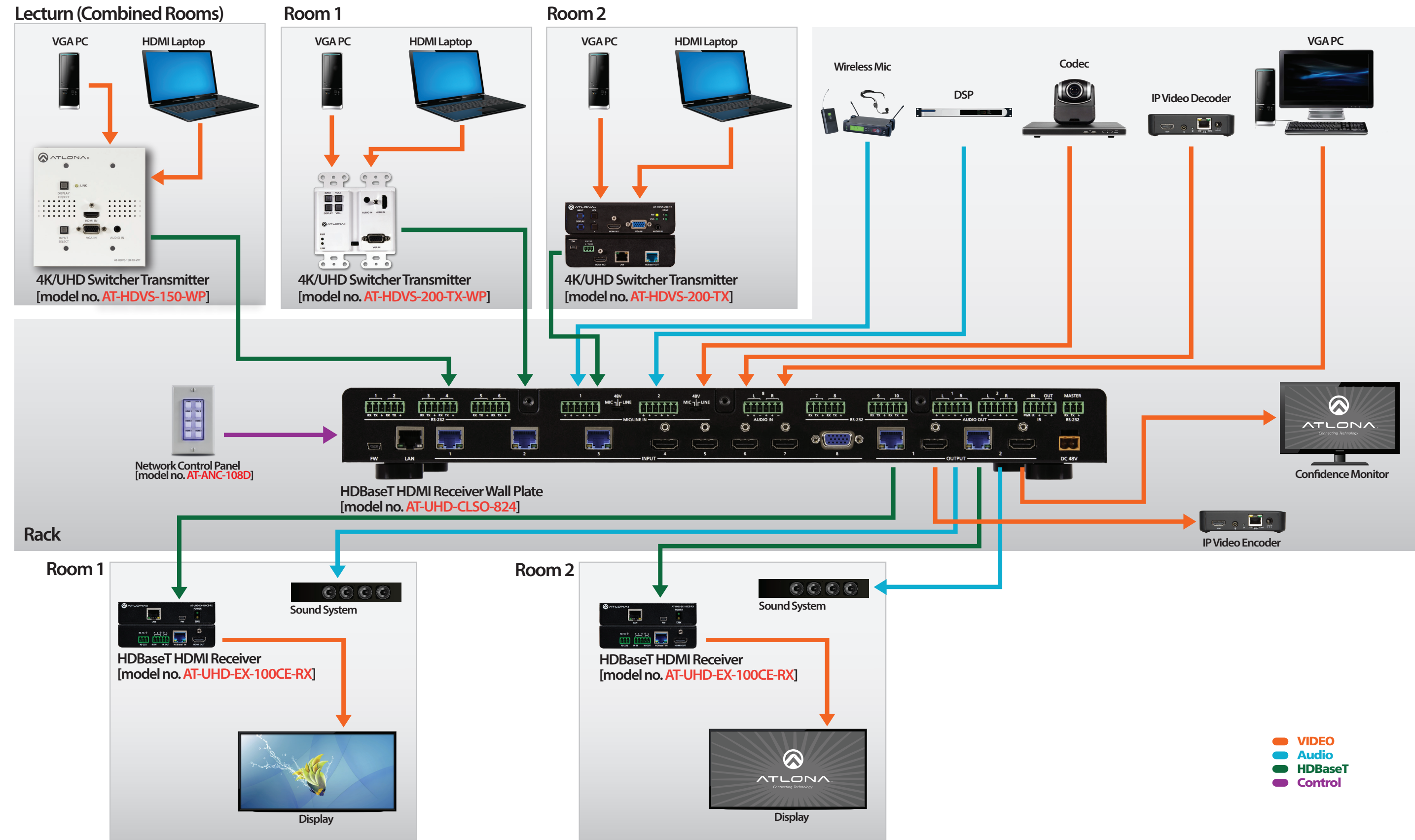

Atlona Whole Home Solution

Simplify your AV system designs by sharing AV sources throughout the home using the UHD PRO3 Series matrix switcher Series. Includes built-in extension technology for 4K/UHD signal distribution.

Equipment Rack

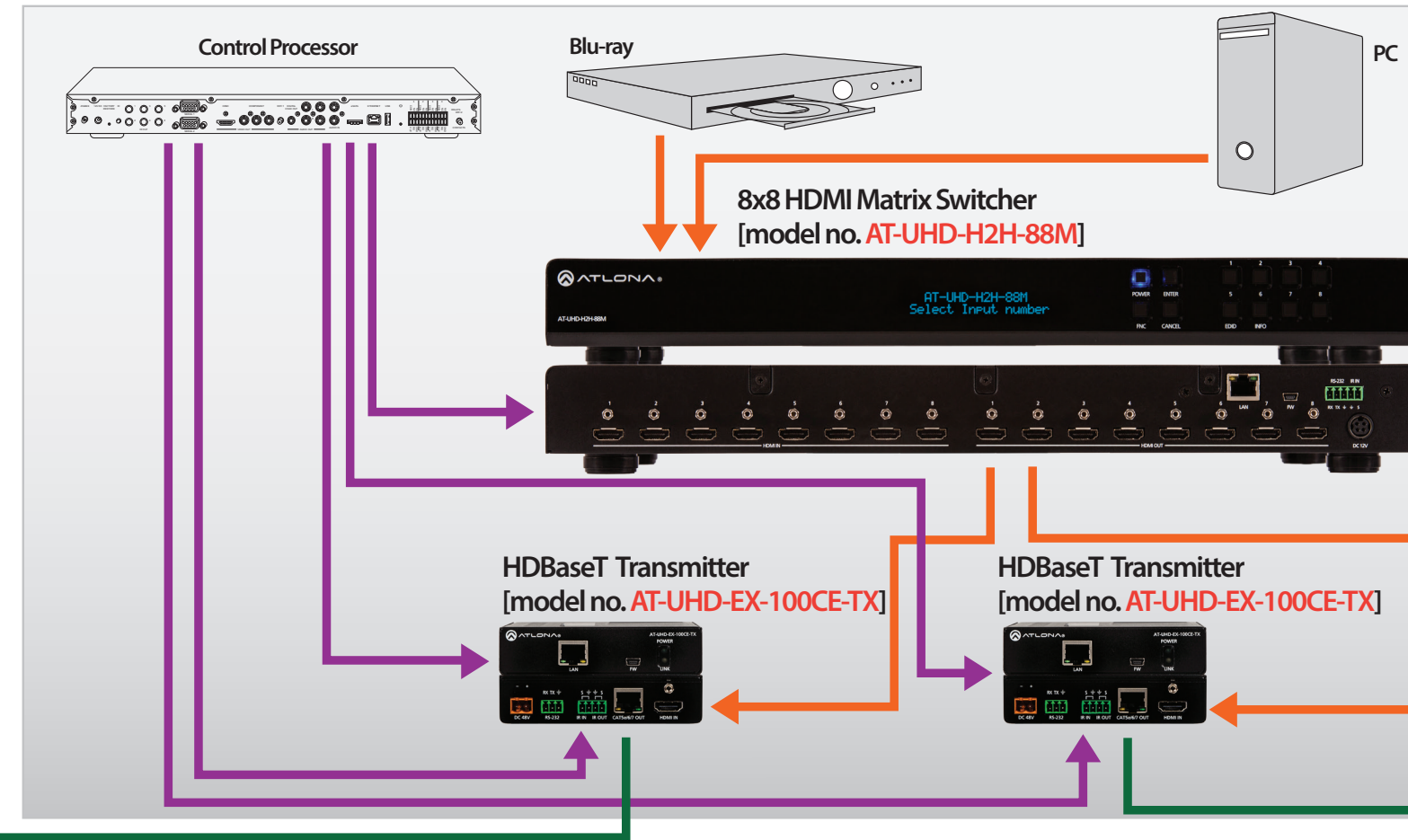

Auditorium with 5.1 Channel Audio

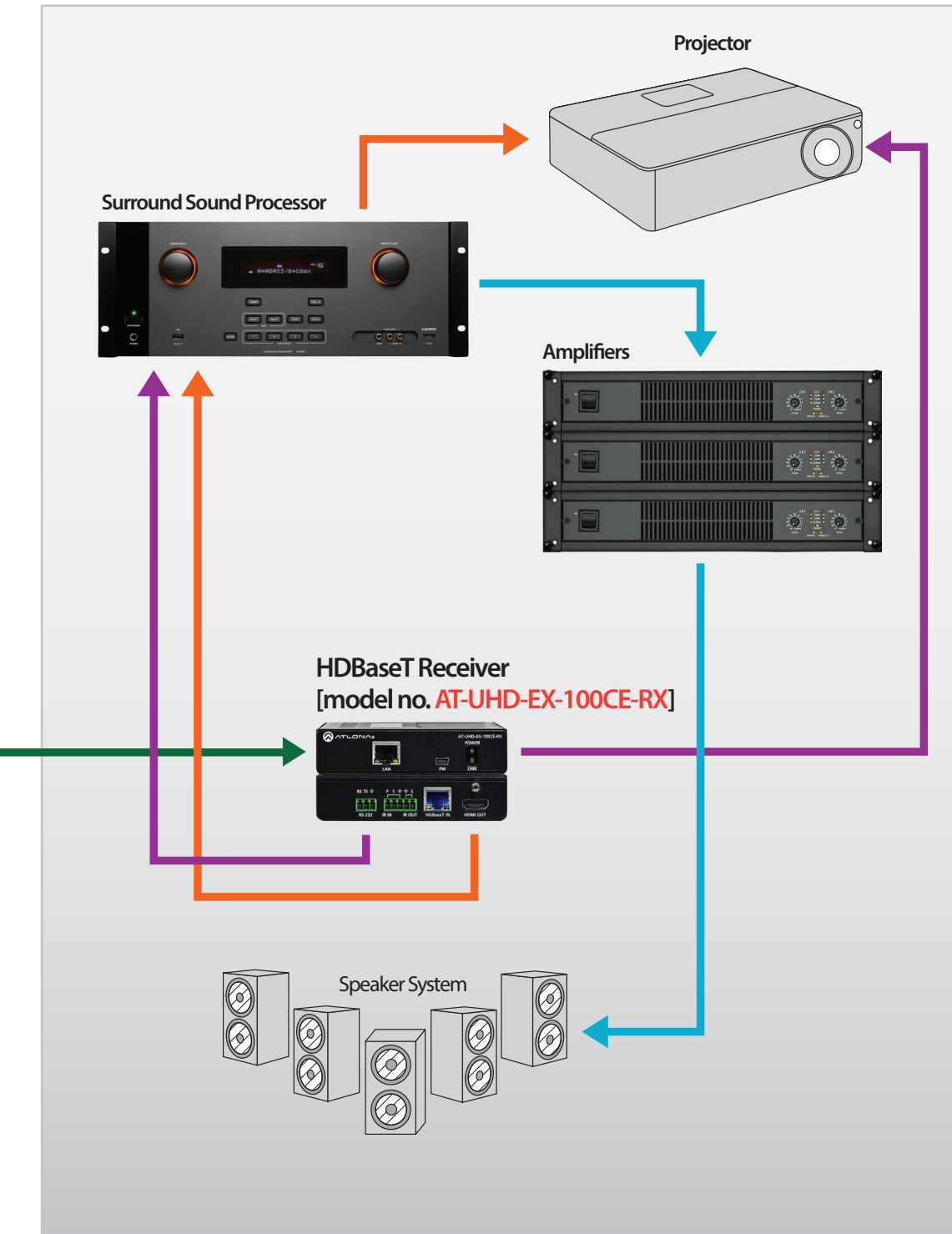

Breakout Room with Mono Audio

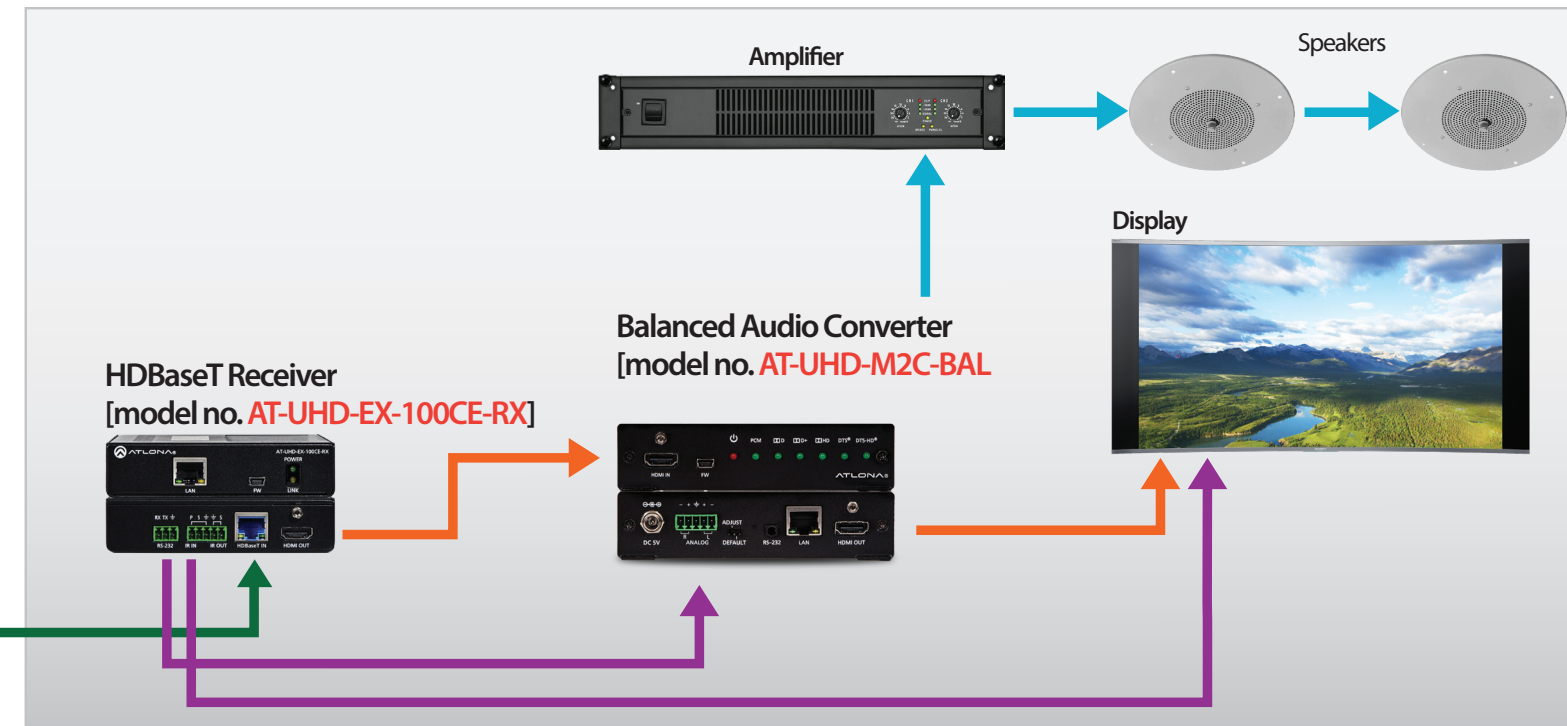

- Analog Video, VGA
- HDMI
- Audio
- HDBaseT
- Control

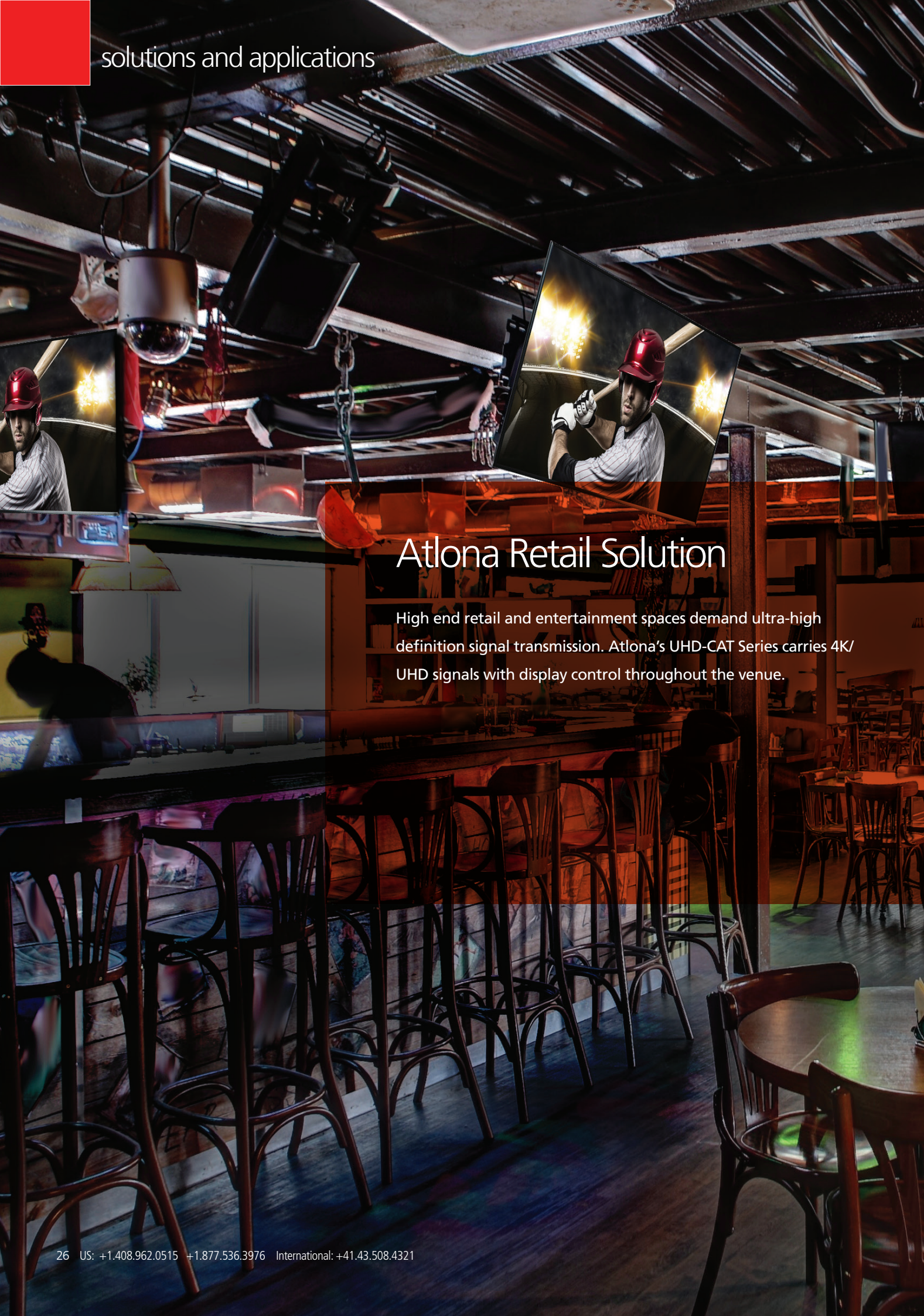

Atlona Retail Solution

High end retail and entertainment spaces demand ultra-high definition signal transmission. Atlona's UHD-CAT Series carries 4K/UHD signals with display control throughout the venue.

Rack (IT Closet)

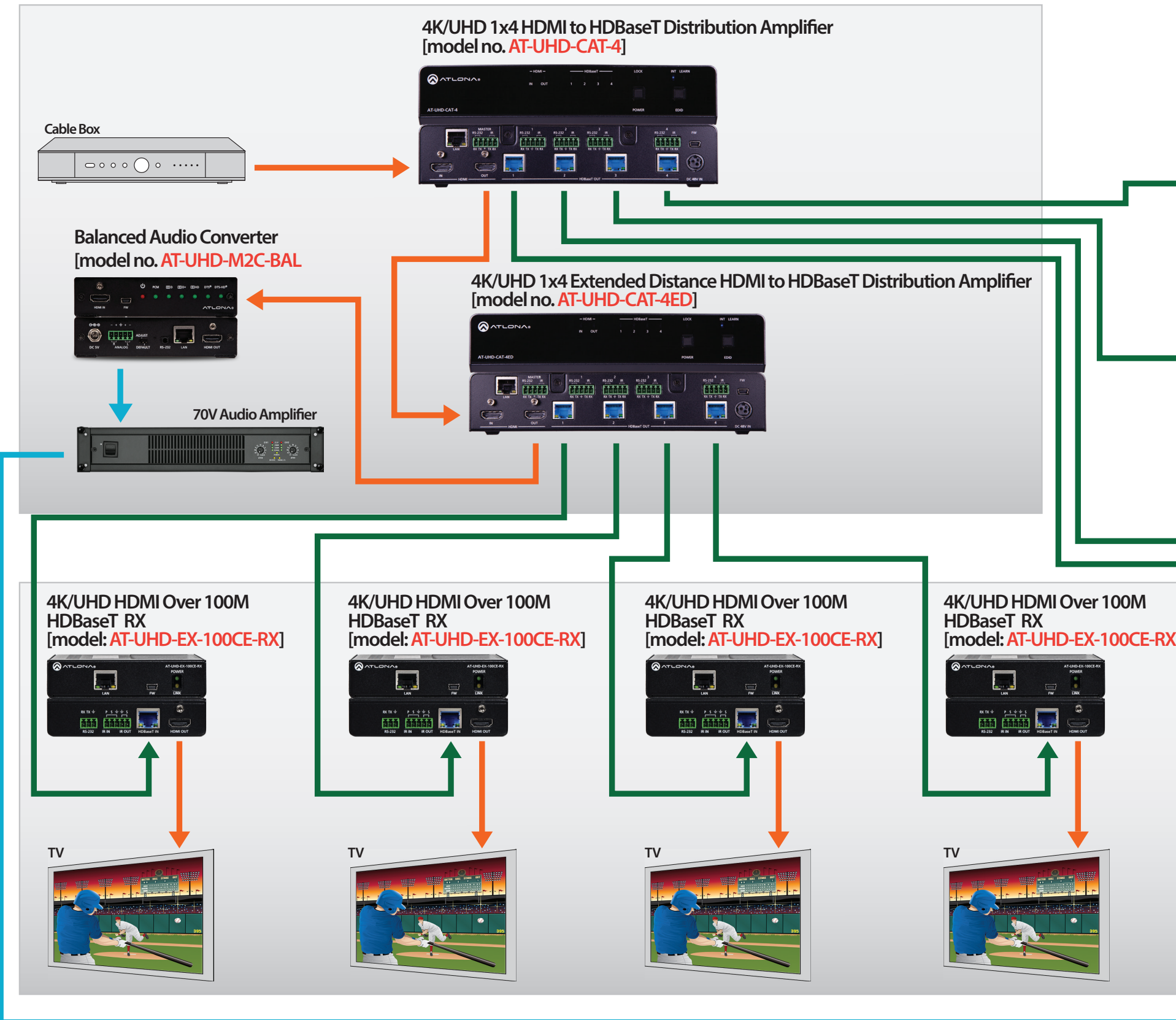

Sports Bar

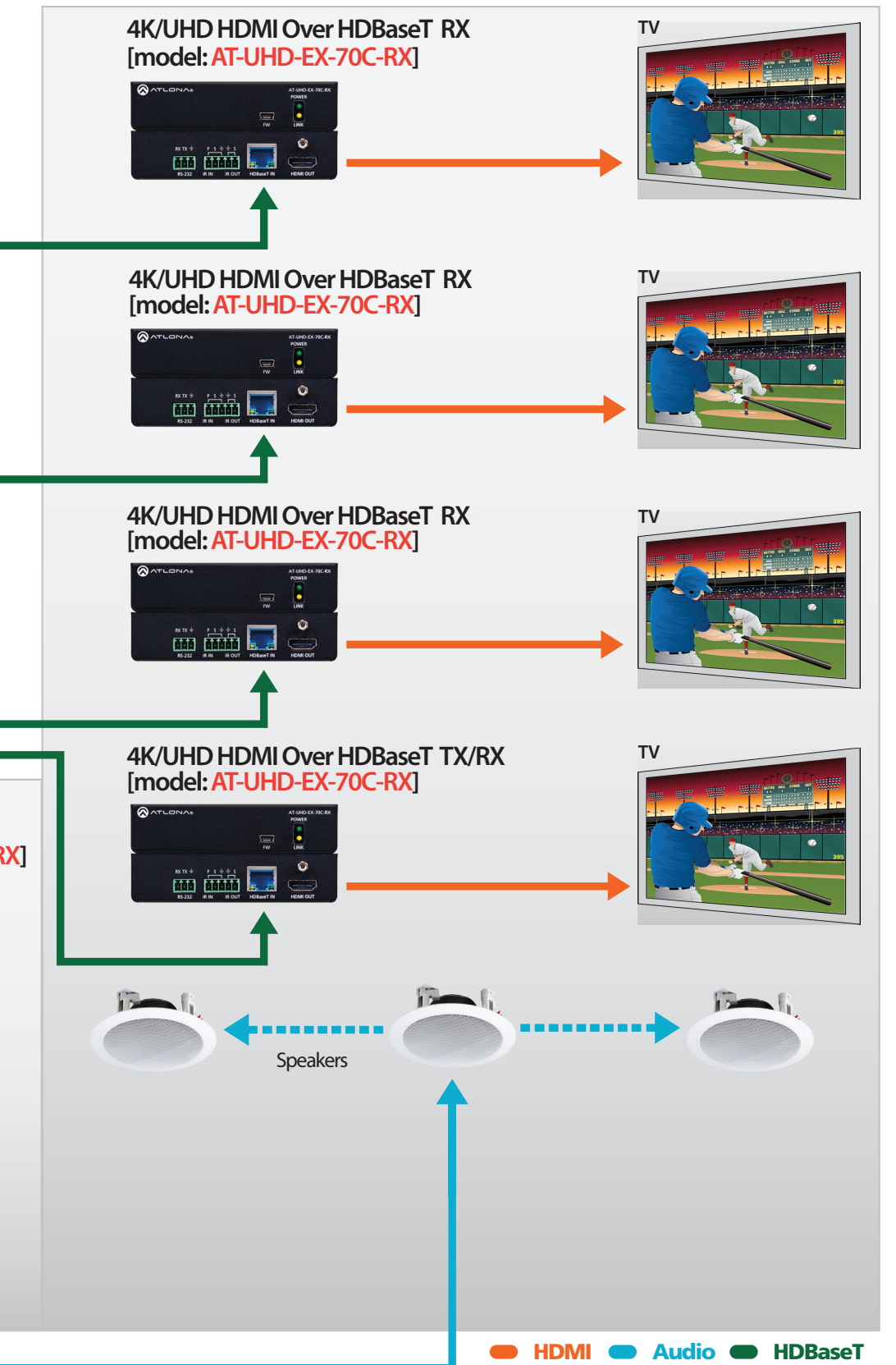

— HDMI — Audio — HDBaseT



Atlona Management System

The Atlona Management System (AMS) is a powerful software resource for select Atlona IP-controllable products in commercial, educational, government and residential environments. It integrates product configuration, management, and updates to reduce installation time and enable remote support. Comprehensive features include: automatic search and detection of Atlona products; device configuration in single or multiple sites; configuration backup, automatic or user-triggered firmware upgrades, and an intuitive graphical user interface.

The AMS is based on a distributed architecture where multiple installed AV devices can be managed from a single server. Using the simple, web browser-based user interface, the operator can drill-down from a high-level network view to an individual device. The operator can choose to manage systems either locally (LAN) or from a remote location (WAN).

Atlona Advantages

NETWORK MANAGEMENT AND CONFIGURATION OF ATLONA IP-CONTROLLABLE PRODUCTS Hierarchical AV system mapping with System, Site, and Equipment levels. Provides full management, configuration and firmware update capabilities.

WEB-BASED GRAPHIC USER INTERFACE Provides easy-to-use and user-friendly graphical illustration of connections between other AV devices and Atlona equipment.

DISTRIBUTED MANAGEMENT ARCHITECTURE Provides management capabilities for multisystem and multi-site network systems. Allows operator to drill down from high-level network view to the individual device.

FIRMWARE DOWNLOAD MANAGEMENT Enables operators to download system-level embedded firmware and to upgrade Atlona devices from a centralized location.

AUTOMATIC FIRMWARE UPGRADE Provides ability to automate firmware upgrades including multiple devices simultaneously. Provides firmware update pass/fail report.

REMOTE CONFIGURATION MANAGEMENT Performs full configuration backup with ability to map configuration to device MAC address, enables configuration push when replacing units, and offers configuration cloning of similar products.

AUTOMATIC ATLONA DEVICE DETECTION Ability to detect installed Atlona devices with product, model, and IP address information.

Product Support Schedule

Product	CURRENT	FEB 2016	FUTURE
AT-ANC-108D			✓
AT-HD-SC-500			✓
AT-HDVS-200-TX		✓	
AT-HDVS-200-TX-WP			✓
AT-HDVS-300-KIT			✓
AT-M2C-BAL			✓
AT-PS-POE			✓
AT-UHD-CAT4			✓
AT-UHD-CAT4ED			✓
AT-UHD-CAT8			✓
AT-UHD-CLSO-601	✓		
AT-UHD-CLSO-612	✓		
AT-UHD-CLSO-612ED			✓
AT-UHD-CLSO-824		✓	
AT-UHD-EX-100-CEA-KIT			✓
AT-UHD-EX-100CE-KIT			✓
AT-UHD-EX-100CE-TX			✓
AT-UHD-H2H-44M			✓
AT-UHD-H2H-88M			✓
AT-UHD-PRO3-1616M			✓
AT-UHD-PRO3-44M		✓	
AT-UHD-PRO3-66M	✓		
AT-UHD-PRO3-88M		✓	
AT-UHD-SW-52ED	✓		
AT-UHD-SW-5000ED			✓
AT-UHD-SW-51			✓
AT-UHD-SW-52	✓		



Switchers

Atlona switching solutions simplify system design and installation, and reduce the complexity of integrating and distributing digital video and audio, media, control, and data.

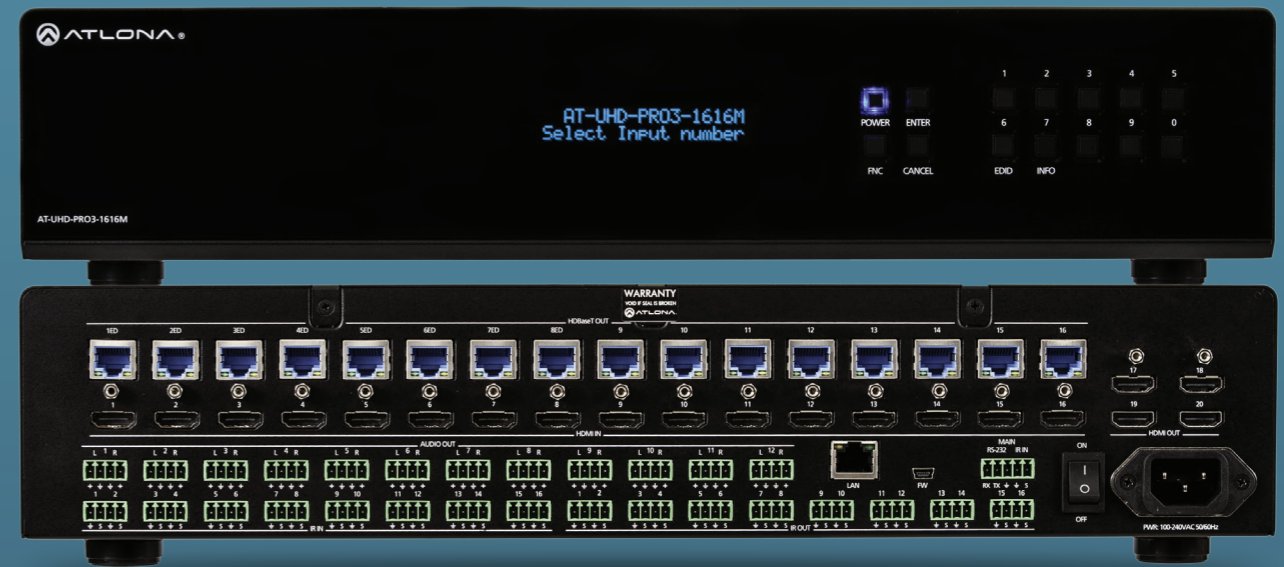

Atlona UHD-PRO3 Matrix Switcher Series

The Atlona UHD-PRO3 Series provides flexible HDBaseT routing with a combination of both long distance, 230 foot (70 meter) transmission and extended distance, 328 foot (100 meter) transmission capabilities with bidirectional extension of both RS-232 and IR Control. Two additional HDMI outputs are provided as mirrored outputs designed for routing HDMI-based audio to an AVR or as additional matrix outputs. The matrix is control system-friendly and integrates with any TCP/IP, RS-232, or IR based control signals.

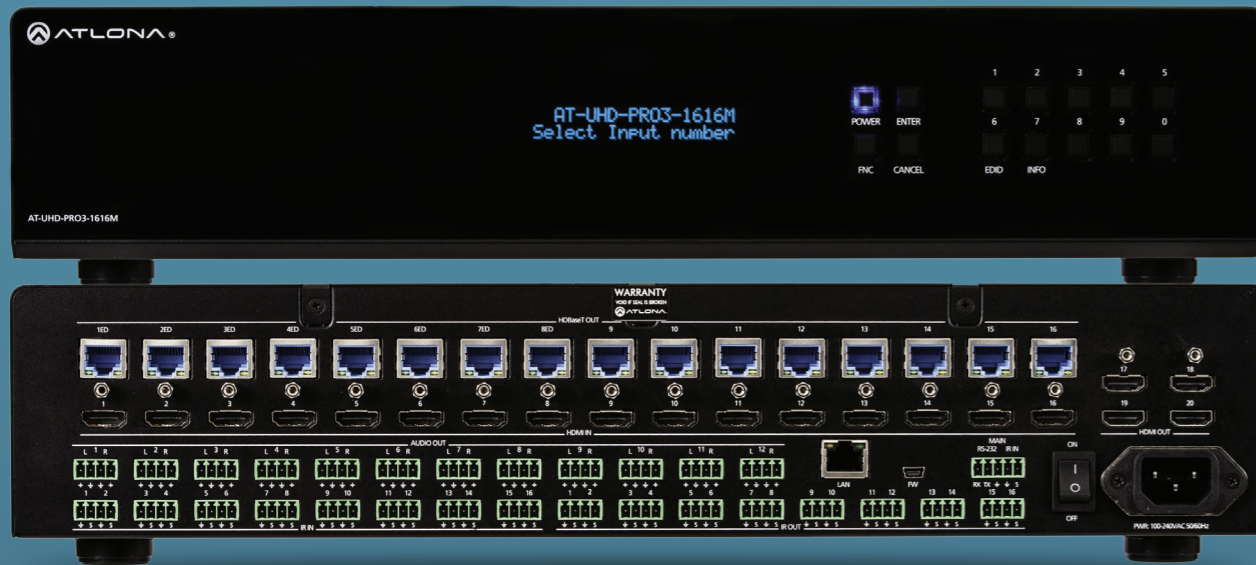

Atlona Advantages

- HDBASET OUTPUTS FOR EXTENSION OF AV, CONTROL AND POWER SIGNALS OVER A SINGLE CATEGORY CABLE** Ensures distance and value requirements are addressed to meet the needs of the installation and budget
- TWO HDMI OUTPUTS WITH INDEPENDENTLY SELECTABLE MIRROR AND MATRIX MODES** Provides output flexibility to facilitate a variety of output needs and destinations
- 4K/UHD CAPABILITY WITH HDCP 2.2 COPY PROTECTION** Future proofs AV systems in preparation for technology improvements, 4K/UHD streaming services and playback devices
- POWER OVER ETHERNET FOR REMOTE-POWERED RECEIVERS** No local AC outlet required; saves time and integration costs
- AUDIO DE-EMBEDDING** Provides audio signal routing to sound system
- TCP/IP, RS-232, AND IR, CONTROL** Reduces integration time and costs

UHD-PRO3 Matrix Switcher Product Options

- 4K/UHD Dual-Distance 16 x 16 HDBaseT Matrix Switcher with PoE [model no. AT-UHD-PRO3-1616M]
- 4K/UHD Dual-Distance 8 x 8 HDBaseT Matrix Switcher with PoE [model no. AT-UHD-PRO3-88M]
- 4K/UHD Dual-Distance 6 x 6 HDBaseT Matrix Switcher with PoE [model no. AT-UHD-PRO3-66M]
- 4K/UHD Dual-Distance 4 x 4 HDBaseT Matrix Switcher with PoE [model no. AT-UHD-PRO3-44M]

Receiver Products

- 4K/UHD HDMI Over 100M HDBaseT Receiver with Ethernet, Control and PoE [model no. AT-UHD-EX-100CE-RX]
- 4K/UHD HDMI Over HDBaseT Receiver with Control and PoE [model no. AT-UHD-EX-70C-RX]

Atlona UHD-PRO3 Matrix Switcher Series

The Atlona UHD-PRO3 Series features HDMI matrix switching that harnesses the powerful capabilities of long-and extended-distance HDBaseT™ technology. The UHD-PRO3 series is compatible with 4K/UHD @ 60Hz video signals and is HDCP 2.2 compliant to meet today's and tomorrow's content management protection schemes. Designed to work with the Atlona AT-UHD-EX-70C-RX and AT-UHD-EX-100C-RX HDBaseT receivers, the UHD-PRO3 Series provides remote powering using industry standard Power over Ethernet.

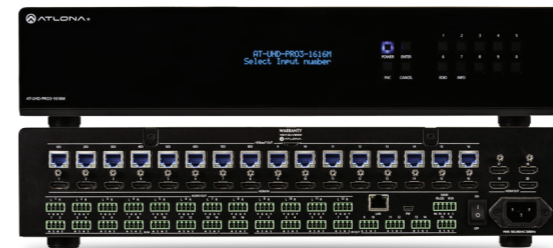

[model no. AT-UHD-PRO3-1616M]

AMS READY



[model no. AT-UHD-PRO3-88M]

AMS READY



[model no. AT-UHD-PRO3-66M]

Works with AMS



[model no. AT-UHD-PRO3-44M]

AMS READY

4K/UHD, 8x2 Multi-Format Matrix Switcher with Dual, HDBaseT™ and Mirrored HDMI Outputs

Designed to be the centerpiece of complex AV systems, the Atlona AT-UHD-CLSO-824 is an 8x2, 4K/UHD matrix switcher with multi-format signal-handling, Ethernet-enabled 100M HDBaseT™ extension, and advanced audio capabilities. It supports presentation space environments by providing three HDBaseT™ inputs, four HDMI inputs, one VGA analog video input and two HDBaseT outputs, each with a mirrored HDMI output. Ethernet-enabled, 328 ft. (100 m) HDBaseT signal extension routes control signals to the end-points along with PoE for remote extender device powering. The AT-UHD-CLSO-824 is designed for conference rooms, classrooms and other dual display spaces or a single display room with teleconference codec.

Atlona Advantages

8x2 MATRIX SWITCHER WITH HDBaseT and HDMI OUTPUTS Eight different sources may be switched to either of two outputs with mirrored HDBaseT/HDMI signals

THREE ETHERNET-ENABLED HDBaseT INPUTS Simplifies integration of remote sources by eliminating power supplies when used with PoE-powered transmitters; single category cable carries AV signals, control and power

FOUR HDMI INPUTS Ideal for sources located at the equipment rack. One multi-function analog input on 15-pin HD connector

TWO ETHERNET-ENABLED, HDBaseT OUTPUTS Extends control signals from third party control processors via HDBaseT along with 4K/UHD video, and audio through a single with cable 328 ft. (100 m) performance

AUDIO OUTPUT MATRIX MIXER Eliminates the need for complex external audio routing systems

Related Products

Three-Input, HDBaseT Switcher with HDMI and VGA Inputs [model no. AT-HDVS-150-TX]

Two-Input, HDBaseT Wall Plate Switcher with HDMI and VGA Inputs [model no. AT-HDVS-150-TX-WP]

4K/UHD, Ethernet-enabled, Three-Input, HDBaseT Switcher with HDMI and VGA Inputs [model no. AT-HDVS-200-TX]

4K/UHD HDMI Over 100M HDBaseT Receiver with Ethernet, Control and PoE [model no. AT-UHD-100CE-RX]

Note: The AT-UHD-CLSO-824 is not compatible with Atlona PoC-Power over Category cable

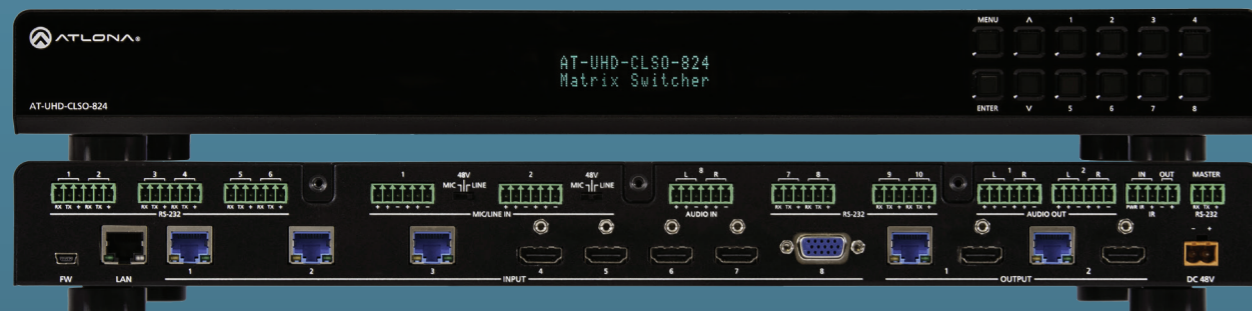

Atlona CLSO (Classroom, Small Office) Switcher Series

The Atlona CLSO Series of switchers and matrix switchers address an array of AV switching, routing, and processing needs from classrooms with HDMI and legacy sources with long distance display runs to complex divisible spaces with different zones and separate display signals to the displays.



[model no. AT-UHD-CLSO-824]

AMS READY

4K/UHD 6 Input Multi-Format Switcher with Mirrored HDMI and HDBaseT™ Outputs and Automatic Display Control

The Atлона AT-UHD-CLSO-612ED is an advanced six-input, multi-format switcher with 4K scaling, Ethernet-enabled HDBaseT™ and PoE capabilities. It simplifies classroom and small office system integration by providing two HDBaseT inputs, two HDMI inputs, two multi-function analog inputs, plus mirrored HDBaseT and HDMI outputs. Advanced Automatic System Control (AASC) features on the switcher provide automatic display control and automatic input selection. Ethernet pass through on the switcher enables control signal pass-through and Internet distribution

Atлона Advantages

HDBaseT INPUTS Work with HDVS-TX box/wall plate for HDMI and VGA sources at lecterns, conference tables, and teacher's desks.

DUAL HDBaseT AND HDMI OUTPUT Connect to an HDBaseT display (or use an AT-HDRX-RSNET receiver) up to 230 feet (70m) away and an HDMI display.

BUILT IN 4K SCALER Up scales to 4K! Down-scaling allows 4K sources to be displayed at 1080p or less. Preferred input resolution can be easily set for best results.

AUTOMATIC DISPLAY CONTROL Automatic display control option makes control simple. Setup from our IP GUI shortens setup time. RS-232 signal-routing to inputs and outputs and translation from IP to RS-232. Use CEC, TCP/IP or RS-232. Drivers available for most control systems.

AUTOMATIC INPUT SELECTION Reduces complexity or eliminates control system completely.

MULTI-FUNCTION ANALOG INPUTS VGA connectors are used for any analog video source including VGA, RGBHV, component, S-, and composite video. Microphone Input: Works with dynamic or phantom powered mics, or with line level inputs from wireless receivers.

AUDIO Balanced, analog audio in/out at +4 dBu, on captive screw connectors. "Sub" volume controls allow matched volume levels from any source.

HDCP MANAGEMENT The HDVS intelligently protects HDCP encoded content. When connected to a teleconference system, user created content is properly passed. This function may be controlled by RS-232 and IP commands.

Related Products

Atлона HDMI (2) and VGA/Audio HDBaseT Extender Switcher w/Display

Control
[model no. AT-HDVS-TX]

Atлона HDMI + VGA/Audio HDBaseT Extender Wall Plate w/Display Control
[model no. AT-HDVS-TX-WP]

Atлона HDMI + VGA/Audio HDBaseT Extender Wall Plate w/Display Control
[model no. AT-HDVS-TX-WP-UK]



[model no. AT-UHD-CLSO-612ED]

AMS READY

4K/UHD 6 Input Multi-format Switcher with Mirrored HDMI and HDBaseT™ outputs, PoE and Automatic Display Control

The Atлона AT-UHD-CLSO-601 is an advanced six-input, multi-format switcher with built-in 4K scaling and mirrored HDBaseT and HDMI outputs. It simplifies classroom and small office system integration by providing four HDMI and two multifunction analog inputs, to enable the use of both new and legacy sources with HDMI displays. The AT-UHD-CLSO-601 can be the central component of an automated AV system. Automatic display control turns on the display automatically whenever a source is connected. When the source is removed, the display is turned off. Volume is controlled by using the front panel buttons. Automatic input selection on the AT-UHD-CLSO-601 works by sensing the presence of any video signal. With automatic input selection, manual control systems can be eliminated.

Atлона Advantages

FOUR HDMI INPUTS Works with PCs, Blu-ray players, document cameras, teleconference systems, wireless solutions with industry standard digital audio/video outputs.

TWO MULTI-FUNCTION ANALOG INPUTS ON 15-PIN HD CONNECTORS Provides input options for legacy analog sources

MIRRORED, DUAL OUTPUTS ON HDBaseT AND HDMI Eliminates cost associated with extra extension components; simplifies installation. HDMI output allows additional HDBaseT transmitter for dual long distance applications.

4K/UHD @ 30 Hz CAPABILITY Supports high resolution applications such as CAD, desktop publishing, and detailed finance reporting

BUILT-IN 4K SCALER Eliminates the need for external scaling components

AUTOMATIC DISPLAY CONTROL Enables display and volume control. CEC enables control of low-cost consumer displays.

AUTOMATIC INPUT SELECTION Reduces complexity or eliminates control system completely.

AV, ETHERNET, AND CONTROL OVER HDBaseT Eliminates multiple cable runs between source, control system router and display

POWER OVER ETHERNET FOR REMOTE-POWERED HDBaseT RECEIVER No local AC outlet required saves time and integration costs

AUTO-SWITCHING Reduces complexity or eliminates control system completely

Related Products

Atлона 4K HDMI Emulator/Tester
[model no. AT-UHD-SYNC]

4K/UHD HDMI Over 100M HDBaseT TX/RX with Ethernet, Control and PoE
[model no. AT-UHD-EX-100CE-KIT]

4K/UHD HDMI Over HDBaseT TX/RX with Control and PoE
[model no. AT-UHD-EX-70C-KIT]

4K/UHD HDMI Over 100M HDBaseT Receiver with Ethernet, Control and PoE
[model no. AT-UHD-EX-100CE-RX]

Note: The AT-UHD-CLSO-601 is not compatible with Atлона PoCc - Power over Category cable



[model no. AT-UHD-CLSO-601]

Works with
AMS

4K/UHD 5 Input HDMI Switcher with Two HDBaseT Inputs and Mirrored HDMI/ HDBaseT Outputs

The Atlona AT-UHD-SW-5000ED is a 5 x 1 switcher with two HDBaseT inputs, three HDMI inputs, mirrored HDMI and HDBaseT outputs, balanced audio outputs, automatic input selection, and advanced display control capability. The HDBaseT inputs match perfectly with the HDVS-200-TX modules to enable VGA and HDMI sources to be easily integrated into a system. The switcher supports 4K/UHD @ 60 Hz, 4:2:0; (10.2 Gbps). It transmits AV signals along with Ethernet, power, and control over a single cable to displays up to 328 feet (100 meters) from the switcher. Control options include automatic input selection, front-panel buttons, and compatibility with IR, RS-232, or TCP/IP-based control systems. Displays are automatically turned on and off using CEC, IP, or RS-232.

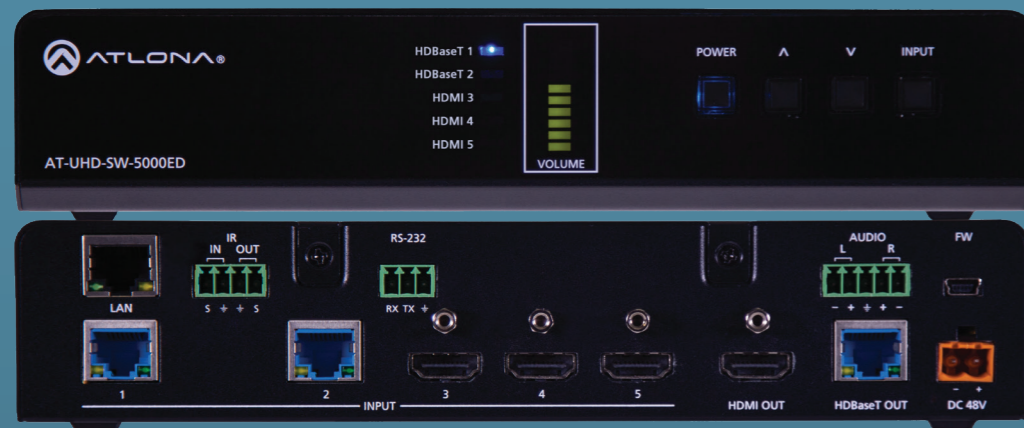

Atlona Advantages

TWO, ETHERNET-ENABLED HDBASET INPUTS Supports two HDVS-150 or HDVS-200 Series transmitters; single category cable carries AV signals, control and power

MIRRORED, DUAL OUTPUTS ON HDMI AND HDBASET Supports dual display environments with local and extended distance 328 foot (100 meter) displays

ETHERNET-ENABLED HDBASET Simplifies installation, maintenance with IP controlled switcher

IR, RS-232 AND ETHERNET HDBASET INSERTION Adds internally-generated or externally-generated display control signals to the HDBaseT transmission

EDID MANAGEMENT AND HDCP MANAGEMENT Manages EDID communications between source and display; Ensures desired audio formats and video resolutions are provided to the AV system

Related Products

Three-Input Switcher for HDMI and VGA Inputs with HDBaseT Output [model no. AT-HDVS-150-TX]

Two-Input Wall Plate Switcher for HDMI and VGA Inputs with HDBaseT Output [model no. AT-HDVS-150-TX-WP]

Three-Input Switcher for HDMI and VGA Sources with Automatic Display Control and Ethernet-Enabled HDBaseT Output [model no. AT-HDVS-200-TX]

Atlona UHD SW-5 Series

The Atlona UHD-SW-5 Series features five-input HDMI switchers with a flexible choice of output configurations including: A single HDMI output; Dual, mirrored HDMI outputs; and HDMI plus HDBaseT™ mirrored outputs. Key features include: Auto-switching; advanced control capability; support for 4K/UHD @ 60 Hz, 4:2:0; 3D pass-through; and 10.2 Gbps bandwidth.

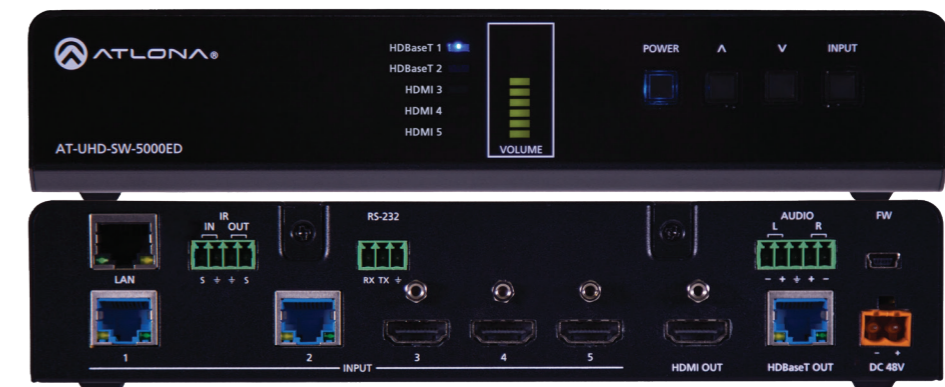

[model no. AT-UHD-SW-5000ED]

AMS READY

4K/UHD 5 Input HDMI Switcher with Mirrored HDMI and HDBaseT Outputs and PoE

The Atлона AT-UHD-SW-52ED is a 5x1 4K/UHD HDMI switcher with HDMI and HDBaseT outputs, balanced analog audio outputs, automatic input selection and automatic display control capability. The switcher supports 4K/UHD @ 60 Hz with 4:2:0 color, offers 3D pass-through, and 10.2 Gbps bandwidth. In addition to an HDMI output, the switcher features a mirrored, Ethernet-enabled HDBaseT output. It transmits AV signals along with Ethernet, power, and control over a single cable to displays up to 328 feet (100 meters) from the switcher to PoE-powered HDBaseT receivers like the Atлона AT-UHD-EX-100CE-RX extender receiver, HDBaseT displays or even another switcher. Control options for the switcher include automatic input selection, front-panel buttons, and compatibility with IR, RS-232, or TCP/IP-based control systems.

Atлона Advantages

MIRRORED, DUAL HDMI OUTPUTS Supports dual display room environments or primary room display and presenter's confidence monitor. Eliminates cost associated with extra distribution amplifier components; simplifies installation

4K/UHD CAPABILITY Supports high resolution applications such as CAD, desktop publishing, and detailed finance reporting

AUTOMATIC DISPLAY CONTROL Enables display and volume control. CEC enables control of low-cost consumer displays.

AUTOMATIC INPUT SELECTION Reduces complexity or eliminates control system completely.

TCP/IP, RS-232, AND IR CONTROL Reduces integration time and costs

EDID MANAGEMENT Ensures desired audio formats and video resolutions are provided to the AV system; eliminates the need for EDID management device

HDCP MANAGEMENT Allows non-protected material from PCs to pass to non-compliant displays and teleconference systems while protected content is not transmitted.

EASY, GUI-BASED CONFIGURATION USING INTEGRATED WEB SERVER Allows fast configuration of internal product settings and troubleshooting from a tablet, smart phone, or PC in the field

RACK MOUNTABLE 1U, HALF RACK WIDTH ENCLOSURE Simplifies installations; allows two units to be mounted together

Related Products

4K/UHD HDMI Over 100M HDBaseT Receiver with Ethernet, Control and PoE
[model no. [AT-UHD-EX-100CE-RX](#)]

4K/UHD HDMI Over 100M HDBaseT TX/RX with Ethernet, Control and PoE
[model no. [AT-UHD-EX-100CE-KIT](#)]

Atлона HDBaseT to HDMI Extender/Scaler
[model no. [AT-UHD-EX-200-RX](#)]

Atлона HDBaseT to HDMI Extender/Scaler
[model no. [AT-UHD-SYNC](#)]



[model no. AT-UHD-SW-52ED



4K/UHD, 5-Input HDMI Switcher

AT-UHD-SW-51

The Atлона AT-UHD-SW-51 is a 5x1 HDMI switcher with automatic input selection and automatic display control capability. The switcher supports 4K/UHD @ 60 Hz with 4:2:0 color, offers 3D pass-through, and 10.2 Gbps bandwidth

Atлона Advantages

4K/UHD CAPABILITY Supports high resolution applications such as CAD, desktop publishing, and detailed finance reporting

AUTOMATIC DISPLAY CONTROL Enables display and volume control. CEC enables control of low-cost consumer displays.

AUTOMATIC INPUT SELECTION Reduces complexity or eliminates control system completely TCP/IP, RS-232, AND IR CONTROL Reduces integration time and costs

EDID MANAGEMENT Ensures desired audio formats and video resolutions are provided to the AV system; eliminates the need for EDID management device

HDCP MANAGEMENT Allows non-protected material from PCs to pass to non-compliant displays and teleconference systems while protected content is not transmitted.

EASY, GUI-BASED CONFIGURATION USING INTEGRATED WEB SERVER Allows fast configuration of internal product settings and troubleshooting from a tablet, smart phone, or PC in the field

RACK MOUNTABLE 1U, HALF RACK WIDTH ENCLOSURE Simplifies installations; allows two units to be mounted together

Related Products

4K/UHD HDMI Over HDBaseT TX/RX with PoE
[model no. [AT-UHD-EX-70-KIT](#)]

4K/UHD HDMI Over 100M HDBaseT TX/RX with Ethernet, Control and PoE
[model no. [AT-UHD-EX-70-2PS](#)]

4K/UHD HDMI Multi-Channel Digital to Two-Channel Balanced Analog Audio Converter
[model no. [AT-UHD-M2C-BAL](#)]

4K/UHD HDMI Over 100M HDBaseT TX/RX with Ethernet, Control and PoE
[model no. [AT-UHD-100CE-KIT](#)]



4K/UHD, 5-Input HDMI Switcher with Mirrored HDMI Outputs

AT-UHD-SW-52

The Atлона AT-UHD-SW-52 is a 5x1 HDMI switcher with dual HDMI outputs, balanced audio outputs, automatic input selection and automatic display control capability. The switcher supports 4K/UHD @ 60 Hz with 4:2:0 color, offers 3D pass-through, and 10.2 Gbps bandwidth.

Atлона Advantages

MIRRORED, DUAL HDMI OUTPUTS Supports dual display room environments or primary room display and presenter's confidence monitor. Eliminates cost associated with extra distribution amplifier components; simplifies installation

4K/UHD CAPABILITY Supports high resolution applications such as CAD, desktop publishing, and detailed finance reporting

AUTOMATIC DISPLAY CONTROL Enables display and volume control. CEC enables control of low-cost consumer displays.

AUTOMATIC INPUT SELECTION Reduces complexity or eliminates control system completely TCP/IP, RS-232, AND IR CONTROL Reduces integration time and costs

EDID MANAGEMENT Ensures desired audio formats and video resolutions are provided to the AV system; eliminates the need for EDID management device

HDCP MANAGEMENT Allows non-protected material from PCs to pass to non-compliant displays and teleconference systems while protected content is not transmitted.

EASY, GUI-BASED CONFIGURATION USING INTEGRATED WEB SERVER Allows fast configuration of internal product settings and troubleshooting from a tablet, smart phone, or PC in the field

RACK MOUNTABLE 1U, HALF RACK WIDTH ENCLOSURE Simplifies installations; allows two units to be mounted together

Related Products

4K/UHD HDMI Over HDBaseT TX/RX with PoE
[model no. [AT-UHD-EX-70-KIT](#)]

4K/UHD HDMI Over 100M HDBaseT TX/RX with Ethernet, Control and PoE
[model no. [AT-UHD-EX-70-2PS](#)]

4K/UHD HDMI Multi-Channel Digital to Two-Channel Balanced Analog Audio Converter
[model no. [AT-UHD-M2C-BAL](#)]

4K/UHD HDMI Over 100M HDBaseT TX/RX with Ethernet, Control and PoE
[model no. [AT-UHD-100CE-KIT](#)]



Atlona 4K/UHD H2H (HDMI to HDMI) Matrix Switcher Series

The Atlona 4K/UHD-H2H (HDMI to HDMI) matrix switcher series simplifies HDMI multi-room distribution. Features include 4K/UHD capability and HDCP 2.2 content protection plus a GUI-based integrated web server for HDCP/EDID reporting, system configuration, and device status. The matrix is control system-friendly and integrates with any TCP/IP, RS-232, or IR-based control system.

Atlona 4K/UHD H2H (HDMI to HDMI) Matrix Switcher

The Atlona 4K/UHD-H2H (HDMI to HDMI) matrix switcher series simplifies HDMI multi-room distribution. Features include 4K/UHD capability and HDCP 2.2 content protection plus a GUI-based integrated web server for HDCP/EDID reporting, system configuration, and device status. The matrix is control system-friendly and integrates with any TCP/IP, RS-232, or IR-based control system.

Atlona Advantages

MULTI ZONE HDMI MATRIX Each source can be simultaneously distributed to all zones

4K/UHD @ 60Hz CAPABILITY WITH HDCP 2.2 COPY PROTECTION Compatible with ultra-high definition PCs and other sources and displays and adheres to latest content protection specification

INTEGRATED WEB SERVER WITH WEB GUI Provides HDCP/EDID reporting, system configuration, and device status plus I/O routing from tablets, smart phones or PCs

TCP/IP, RS-232, AND IR, CONTROL Flexible control options compatible with any 3rd-party control system

4K/UHD Matrix Switcher Options

Atlona 8x8 HDMI to HDMI Matrix Switcher [model no. AT-UHD-H2H-88M]

Atlona 4x4 HDMI to HDMI Matrix Switcher [model no. AT-UHD-H2H-44M]



[model no. AT-UHD-H2H-88M]

AMS READY



[model no. AT-UHD-H2H-44M]

AMS READY



Atlona 4 x 2 HDMI Switcher w/Mirrored HDMI Outputs

AT-HD4-V42

The switcher designed for systems on a budget. Easy to integrate.

Atlona Advantages

DUAL OUTPUTS View source signals on two mirrored monitors

FLEXIBLE 3D AND 1080P VIDEO PERFORMANCE Better video experience with 3D compatibility and 1080p video

ARC Routes audio from compatible HDMI displays to AV receivers via a S/PDIF cable

AUDIO DE-EMBED De-embeds audio from HDMI signals to S/PDIF for integration with external audio amplifiers

HDMI ETHERNET CHANNEL Passes Ethernet through HDMI cable to HEC-capable displays

IR AND RS-232 CONTROL for easy system integration

AUTO-SWITCHING selects last source connected or turned on



Atlona 4 x 1 HDMI Switcher

AT-HD4-V41

A switcher designed for systems on a budget, with a single HDMI video output. Easy to integrate.

Atlona Advantages

EXCELLENT HD VIDEO Capable of resolutions up to 1080p to ensure compatibility with most sources

ARC Routes audio from compatible HDMI displays to AV receivers via a S/PDIF cable

AUDIO DE-EMBED De-embeds audio from HDMI signals to S/PDIF for integration with external audio amplifiers

HDMI ETHERNET CHANNEL Passes Ethernet through HDMI cable to HEC-capable displays

IR AND RS-232 CONTROL for easy system integration

AUTO-SWITCHING selects last source connected or turned on



Atlona 2 x 1 Signal Sensing Automatic VGA and Stereo Audio Switcher

AT-APC21A

The automatic stereo audio switcher for two VGA inputs plus stereo audio, with smart auto-switch that simplifies operation, plus easy installation via magnetic pad.

Atlona Advantages

2 VGA INPUTS Switches two VGA inputs and audio to one VGA and 3.5 mm audio output

INTELLIGENT AUTO-SWITCHING Switches automatically to the last source activated

WIRED REMOTE Includes a manual control pendant to switch sources

EASY INSTALLATION with a built-in magnetic pad

SELF-POWERED Powered through VGA connector (when supported by PC manufacturer); external power supply included if needed



AMS READY

8-Button Network Control Panel

AT-ANC108D

The Atlona AT-ANC-108D is an 8-button network control panel for Atlona IP-based switchers. It is designed for easy configuration using the free Atlona Management System (AMS) software resource. Only one category cable needs to be connected to the AT-ANC-108D ensuring fast, hassle-free installation of control signal and power

Atlona Advantages

REMOTE CONTROL PANEL Provides an additional point of control in a meeting space to simplify system control

FAST INSTALLATION, SINGLE CABLE INTEGRATION Speeds installation and reduces labor costs

AMS CONFIGURABLE Reduces costs of AV systems by eliminating complex control system programming

EIGHT, SOFT-TOUCH, BACK-LIT BUTTONS Easy for end users to operate

FLEXIBLE POWERING Simplifies installation based on available power resources

Distribution Amplifiers

Atlona distribution amplifier solutions are designed and engineered for greater system reliability, compatibility and performance. Distribute a source to multiple displays with the benefit of easier installation and upgrading.



Atlona UHD-CAT (HDMI to HDBaseT) Distribution Amplifier Series

Atlona's UHD-CAT series offers 4K/UHD distribution with HDCP 2.2 and HDBaseT outputs, choice of four or eight output versions with 70 meter performance plus a four output Ethernet-enabled version. The features also offers automatic display control and eliminated extra boxes and power supplies. The AT-UHD-CAT series integrates with any TCP/IP, RS-232, or IR control system and features a 1U, half-rack width enclosure with external, international power supply.

4K/UHD 4-Output HDMI to HDBaseT Extended Distance Distribution Amplifier

The Atlona AT-UHD-CAT-4ED is a 4K/UHD HDMI to HDBaseT™ distribution amplifier featuring pass-through HDMI input connections, four extended distance, Ethernet-enabled HDBaseT outputs and display control capability. Each output transmits AV and control signals up to 328 ft. (100 m). Features include 4K/UHD @ 60 Hz with 4:2:0 color subsampling, HDCP 2.2 compliance, EDID management, and PoE for powering remote receivers. A wide variety of consumer and commercial displays may be controlled by the AT-UHD-CAT-4ED using CEC, IR, RS-232 or IP.

Atlona Advantages

- BUILT-IN HDBASET TRANSMISSION** Reduces overall system costs, speeds installation and prevents compatibility issues
- FOUR ETHERNET-ENABLED HDBASET OUTPUTS** Additional options for display placement
- 4KUHD DISPLAY CAPABILITY** Ensures AV distribution systems are ready for 4K/UHD streaming services and playback devices
- AUTOMATIC DISPLAY CONTROL** Enables display and volume control.

Receiver Products

- 4K/UHD HDMI Over 100M HDBaseT Receiver with Ethernet, Control and PoE [model no. AT-UHD-EX-100CE-RX]
- 4K/UHD HDMI Over HDBaseT Receiver with Control and PoE [model no. AT-UHD-EX-70C-RX]

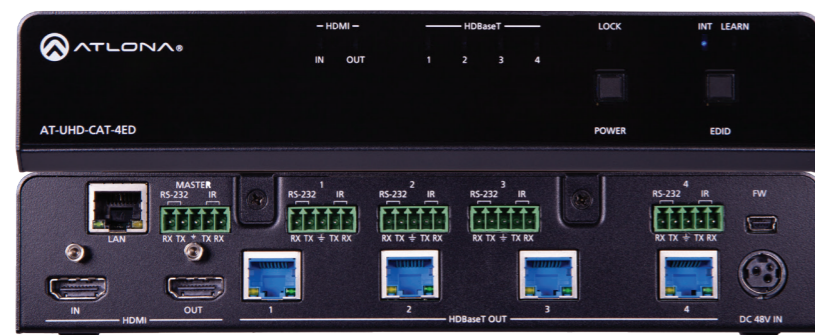

[model no. AT-UHD-CAT-4ED]



Atlona 1 x 8 and 1 x 4 HDMI to HDBaseT Distribution Amplifiers

Atlona's AT-UHD-CAT-8 and AT-UHD-CAT-4 distribution amplifiers use HDBaseT to distribute to eight or four displays at distances as far as 230 feet (70 meters). Automatic display control enables control of a wide variety of displays including commercial or low cost consumer displays. Power over Ethernet (PoE) powers remote receivers, eliminating the need for additional AC outlet.

Atlona Advantages

- HDMI DISTRIBUTION AMPLIFIER WITH BUILT-IN HDBASET TRANSMISSION** for video up to 230 ft (70 m) @ 1080p and 130 ft (40m) @ 4K/UHD
- POWER OVER ETHERNET FOR REMOTE-POWERED HDBASET RECEIVER** No local AC outlet required saves time and integration costs
- 4K/UHD CAPABILITY WITH HDCP 2.2 COPY PROTECTION** Ensures AV distribution systems are ready for 4K/UHD streaming services and playback devices
- DISPLAY CONTROL** CEC, IR or RS-232 control signals transmitted over HDBaseT

Receiver Product

- 4K/UHD HDMI Over HDBaseT Receiver with Control and PoE [model no. AT-UHD-EX-70C-RX]



[model no. AT-UHD-CAT-8]



[model no. AT-UHD-CAT-4]





Atlona HDDA HDMI Distribution Amplifier Series

Atlona's HDDA Series is the first distribution amplifier available on the market that supports up to 4K/UHD. Ideal for TV showrooms and digital signage with displays demonstrating cutting edge Ultra HD resolution. Analog and digital audio de-embedding allows input to sound systems in a sports bar or other hospitality or entertainment venue.

Atlona 1 x 8 HDMI Distribution Amplifiers

This distribution amplifier supports 4K/UHD, advanced-EDID management and audio de-embedding. For added reliability use an Atlona optional redundant power supply.

Atlona Advantages

- PASSES 4K/UHD
- LINK STATUS LED for source and outputs
- ADVANCED EDID MANAGEMENT Learns reference EDID from first output device connected
- SUPPORTS 3D up to 12-bit Deep Color
- PASSES DOLBY TRUE HD, DTS-HD MASTER AUDIO
- OPTIONAL REDUNDANT POWER SUPPLY for added reliability in critical environments
- AUDIO DE-EMBEDDING via 1 x S/PDIF and 1 x balanced audio captive screw
- LOCKING HDMI and power connectors
- CASCADE UP TO 8 DISTRIBUTION AMPLIFIERS (@ 1080P) for large systems
- UPDATE IN THE FIELD via USB port
- DUAL PURPOSE WALL MOUNT/RACK brackets

Related Products

- Atlona LinkConnect Captive Screw 2-Channel Cable [model no. AT-LC-CS-2CH-2M]
- Atlona Optional Redundant Power Supply [model no. AT-PW24V6.25A]



[model no. AT-HDDA-8]

Atlona 1 x 4 HDMI Distribution Amplifier

The Atlona AT-HDDA-4 is a 1x4 HDMI to HDMI distribution amplifier supporting 4K/UHD signals. 4 zones with advanced EDID management, ideal for displays using cutting-edge Ultra HD resolution.

Atlona Advantages

- PASSES 4K/UHD
- LINK STATUS LED for source and outputs
- ADVANCED EDID MANAGEMENT Learns reference EDID from first output device connected
- CASCADE up to 8 distribution amplifiers (@1080p) for large systems
- SUPPORTS 3D up to 48-bit Deep Color
- PASSES DOLBY TRUE HD, DTS-HD MASTER AUDIO
- LOCKING HDMI and power connectors
- UPDATE IN THE FIELD via USB port
- DUAL PURPOSE WALL MOUNT/RACK brackets

Related Products

- Atlona HDBaseT Transmitter over a Single Category Cable [model no. AT-HDTX]
- Atlona HDBaseT Receiver over a Single Category Cable [model no. AT-HDRX]
- 4K/UHD HDMI Over HDBaseT TX/RX with PoE [model no. AT-UHD-70-KIT]
- 4K/UHD HDMI Over 100M HDBaseT TX/RX with Ethernet, Control and PoE [model no. AT-UHD-EX-100CE-KIT]
- 4K/UHD HDMI Over HDBaseT TX/RX Kit [model no. AT-UHD-EX-70-2PS]
- 4K/UHD HDMI Over HDBaseT TX/RX with Control and PoE [model no. AT-UHD-EX-70C-KIT]



[model no. AT-HDDA-4]

Atlona 1 x 2 HDMI Distribution Amplifier

The Atlona AT-HDDA-2 is a 1x2 HDMI to HDMI distribution amplifier supporting 4K/UHD signals. 2 zones, advanced EDID management, and easy installation, integration, and upgrades.

Atlona Advantages

- PASSES 4K/UHD
- LINK STATUS LED for source and outputs
- ADVANCED EDID MANAGEMENT Learns reference EDID from first output device connected
- CASCADE up to 8 distribution amplifiers (@1080p) for large systems
- SUPPORTS 3D up to 48-bit Deep Color
- PASSES DOLBY TRUE HD, DTS-HD MASTER AUDIO
- LOCKING HDMI and power connectors
- UPDATE IN THE FIELD via USB port
- DUAL PURPOSE WALL MOUNT/RACK brackets

Related Products

- Atlona HDBaseT Transmitter over a Single Category Cable [model no. AT-HDTX]
- Atlona HDBaseT Receiver over a Single Category Cable [model no. AT-HDRX]
- 4K/UHD HDMI Over HDBaseT TX/RX with PoE [model no. AT-UHD-70-KIT]
- 4K/UHD HDMI Over 100M HDBaseT TX/RX with Ethernet, Control and PoE [model no. AT-UHD-EX-100CE-KIT]
- 4K/UHD HDMI Over HDBaseT TX/RX Kit [model no. AT-UHD-EX-70-2PS]
- 4K/UHD HDMI Over HDBaseT TX/RX with Control and PoE [model no. AT-UHD-EX-70C-KIT]



[model no. AT-HDDA-2]

Extenders

Atlona extender solutions are ideal for use in point to point applications for transmission over greater distances than HDMI can support with 4K/UHD capability, configuration-free set-up, and field-updateable firmware and an affordable price point.



Atlona HDBaseT™ Extender Series

Our series of HDBaseT extenders offers up to 4K/UHD at longer distances, remote receiver power capability, and options for control, distance, form factor, and connectors, so you can customize an installation with just the right features while reducing costs.

Atlona 4K/UHD Extender Series

Our newest series of HDMI signal extenders for long distance and extended distance transmission, all feature 4K/UHD capability and HDCP 2.2 copy protection pass-through. The new UHD-EX Series of extenders consists of four pairs of transmitters and receivers, all employing HDBaseT™ technology, with a range of models that offer increasing levels of features including 70- or 100-meter signal extension of video, multi-channel audio, 48-volt Power over Ethernet, and bidirectional Ethernet, IR, and RS-232, all over a single category cable.

4K/UHD HDMI Over 100M HDBaseT TX/RX with Ethernet, Control and PoE

AT-UHD-EX-100CE-KIT

HDBaseT™ transmitter/receiver kit for HDMI transmission up to 328 feet (100 meters) over category cable with Ethernet pass through, RS-232 and IR control, plus Power over Ethernet.

Atlona Advantages

EXTENDED DISTANCE HDMI EXTENSION Transmits HDMI signals up to 328 ft (100m) @ 1080P and 328 ft (100m) @ 4K/UHD using CAT6a/7 cable

AV, ETHERNET, POWER, AND CONTROL OVER HDBASET Eliminates multiple cable runs between source, control system, router, and display

REMOTE-POWERED RECEIVER Saves time and integration costs

4K/UHD CAPABILITY Future proofs AV systems in preparation for technology improvements, 4K/UHD streaming services and playback devices

HDCP 2.2 COMPLIANT Allows protected content stream to pass between devices

REAR PANEL I/O CONNECTORS Saves installation time and eliminates clutter

LOW-PROFILE, 1 INCH (2.5 CM) HIGH QUARTER RACK-WIDTH ENCLOSURE Keeps devices out-of-sight when placed in public spaces

Available as a Kit, TX, or RX



[model no. AT-UHD-EX-100CE-KIT]



[model no. AT-UHD-EX-100CEA-KIT]



4K/UHD HDMI Over 100M HDBaseT TX/RX with Ethernet, Control and PoE, and Return Optical Audio

AT-UHD-EX-100CEA-KIT

HDBaseT™ transmitter/receiver kit for HDMI transmission up to 328 feet (100 meters) over category cable with Ethernet pass through, RS-232 and IR control, Power over Ethernet, and optical audio from receiver to transmitter.

Atlona Advantages

RECEIVER TO TRANSMITTER DIGITAL AUDIO PATHWAY Routes multi-channel audio from TV to AVR on same extender and cable as video from set top box to TV

AV, ETHERNET, POWER, AND CONTROL OVER HDBASET Eliminates multiple cable runs between source, control system, router, and display

REMOTE-POWERED RECEIVER Saves time and integration costs

4K/UHD CAPABILITY Future proofs AV systems in preparation for technology improvements, 4K/UHD streaming services and playback devices

HDCP 2.2 COMPLIANT Allows protected content stream to pass between devices

4K/UHD HDMI Over HDBaseT Kit with PoE

AT-UHD-EX-70-KIT

HDBaseT transmitter/receiver kit for HDMI transmission up to 230 feet (70 meters) over category cable with Power over Ethernet capability.

Atlona Advantages

LONG DISTANCE HDMI EXTENSION Transmits HDMI signals up to 230 ft (70m) @ 1080P and 130 ft (40m) @ 4K/UHD using CAT6a/7 cable

4K/UHD CAPABILITY Future proofs AV systems in preparation for technology improvements, 4K/UHD streaming services and playback devices

HDCP 2.2 COMPLIANT Allows protected content stream to pass between devices

REAR PANEL I/O CONNECTORS Saves installation time and eliminates clutter

LOW-PROFILE, 1 INCH (2.5 CM) HIGH QUARTER RACK-WIDTH ENCLOSURE Keeps devices out-of-sight when placed in public spaces



[model no. AT-UHD-EX-70-KIT]

4K/UHD HDMI Over HDBaseT Kit with Control and PoE

AT-UHD-EX-70C-KIT

HDBaseT™ transmitter/receiver kit for HDMI transmission up to 230 feet (70 meters) over category cable with RS-232 and IR control plus Power over Ethernet capability

Atlona Advantages

LONG DISTANCE HDMI EXTENSION Transmits HDMI signals up to 230 ft (70m) @ 1080P and 130 ft (40m) @ 4K/UHD using CAT6a/7 cable

BIDIRECTIONAL EXTENSION OF BOTH RS-232 AND IR CONTROL COMMANDS Eliminates multiple cable runs between source, control system, and display

REMOTE-POWERED RECEIVER Saves time and integration costs

4K/UHD CAPABILITY Future proofs AV systems in preparation for technology improvements, 4K/UHD streaming services and playback devices

HDCP 2.2 COMPLIANT Allows protected content stream to pass between devices

REAR PANEL I/O CONNECTORS Saves installation time and eliminates clutter

LOW-PROFILE, 1 INCH (2.5 CM) HIGH QUARTER RACK-WIDTH ENCLOSURE Keeps devices out-of-sight when placed in public spaces

Available as a Kit or RX



[model no. AT-UHD-EX-70C-KIT]

4K/UHD HDMI Over HDBaseT Kit

AT-UHD-EX-70-2PS-KIT

HDBaseT transmitter/receiver kit for HDMI transmission up to 230 feet (70 meters) over category cable using locally-powered endpoints.

Atlona Advantages

LONG DISTANCE HDMI EXTENSION Transmits HDMI signals up to 230 ft (70m) @ 1080P and 130 ft (40m) @ 4K/UHD using CAT6a/7 cable

4K/UHD CAPABILITY Future proofs AV systems in preparation for technology improvements, 4K/UHD streaming services and playback devices

HDCP 2.2 COMPLIANT Allows protected content stream to pass between devices

REAR PANEL I/O CONNECTORS Saves installation time and eliminates clutter

LOW-PROFILE, 1 INCH (2.5 CM) HIGH QUARTER RACK-WIDTH ENCLOSURE Keeps devices out-of-sight when placed in public spaces



[model no. AT-UHD-EX-70-2PS-KIT]

Atlona HDBaseT™ RSNET Extender Series

w/Ethernet, IR and RS-232

Our RSNET series has been specially engineered for high-resolution, reliable signal transmission to 328 feet (100 meters). Complete Ethernet, IR and RS-232 control, rigorously tested for interoperability and compatibility with third party control systems.

Atlona Advantages

- MAXIMUM DISTANCE** up to 328 ft (100 m)
- POWER OVER CATEGORY CABLE (PoC)** No power is needed at the receiver
- COMPLETE EASY CONTROL** Ethernet, RS-232 and bi-directional IR
- SUPPORTS ULTRA HD (4Kx2K)**
- MOUNTING EARS** included
- UPDATE IN THE FIELD** via USB port
- HIGH EMI REJECTION** for compatibility in even the most challenging installations
- EXTENDS ALL EMBEDDED AUDIO** signals including Dolby TrueHD and DTS-HD Master Audio
- CAPTIVE SCREW CONNECTORS** for power, IR, and RS-232 add reliability and improve wire management
- COMPATIBILITY** Designed for use with AT-HDCAT-8ED distribution amplifiers for full distance
- CEC PASS-THROUGH** so it's easier to control the entire system
- DIRECT WIRE INTERFACE** from TX or RX to third-party IR and RS-232 control systems

RSNET Product Options

- RSNET for traditional extender applications
- Atlona HDBaseT TX HDMI Transmitter w/Ethernet, RS-232, and IR [model no. [AT-HDTX-RSNET](#)]
- Atlona HDBaseT RX HDMI Receiver w/Ethernet, RS-232, and IR [model no. [AT-HDRX-RSNET](#)]
- RSNET wall plates for in-wall installation behind a display
- Atlona HDBaseT RX HDMI 2-Gang US Decora Wall Plate w/ Ethernet, RS-232, and IR [model no. [AT-HDWP-RSNET](#)]
- Atlona HDBaseT RX HDMI 2-Gang UK Wall Plate w/Ethernet, RS-232, and IR [model no. [AT-HDWP-RSNET-UK](#)]
- RSNET DVI extenders for applications that use DVI for video
- Atlona HDBaseT TX DVI Transmitter w/Ethernet, RS-232, and IR [model no. [AT-DVITX-RSNET](#)]
- Atlona HDBaseT RX DVI Receiver w/Ethernet, RS-232, and IR [model no. [AT-DVIRX-RSNET](#)]

Related Products

- Atlona LinkConnect Captive Screw RS-232 Cable [model no. [AT-LC-CS-RS232-2M](#)]



[model no. AT-HDTX-RSNET Transmitter] [model no. HDRX-RSNET Receiver]



[model no. AT-HDWP-RSNET Receiver] [model no. AT-HDWP-RSNET-UK Receiver]



[model no. AT-DVITX-RSNET Transmitter] [model no. DVIRX-RSNET Receiver]



Atlona HDVS Switcher/Scaler Series

Atlona's HDVS Switcher/scaler series was designed to smooth the transition from analog to digital displays in schools and businesses. While some systems use HDMI computers, Blu-ray players, or document cameras, there are numerous VGA computers still in use, and this series supports both. Together, these components can lower the cost of a complete, simple system with VGA and HDMI inputs and display control.

Atlona HDVS 150 Series

The Atlona HDVS-150 Series are switchers with automatic display control for HDMI and VGA transmission over HDBaseT™. They feature one or two HDMI inputs plus a VGA input with 3.5mm audio connector. Designed as remote input devices for the AT-UHD-CLSO-824 matrix switcher, these combine the benefits of a switcher with built-in auto-switching and the advantages of long-distance HDBaseT signal extension over a single cable. HDMI signals up to 4K/ UHD @ 60Hz with embedded audio, VGA input signals up to 1920x1200 video, and control signals can be extended up to 230 feet (70 meters). The switchers receive power from the AT-UHD-CLSO-824 using Power over Ethernet.

Atlona Advantages

- LONG DISTANCE HDMI EXTENSION** Transmits HDMI and VGA/ Audio signals up to 230 ft (70m) @ 1080p over CAT6a/7 and 197 feet (60 m) @1080p over CAT5e/6
- AUTO-SWITCHING SELECTS** active input when sources are connected or if there is a change in source power status
- FRONT PANEL INPUT SELECT BUTTON** Overrides auto-switching when two active sources are present
- AUTO DISPLAY CONTROL** Automatically changes projector power state as sources are connected or removed from inputs
- FRONT PANEL DISPLAY ON/OFF** control Remotely controls display power state; provides alternate 'Display Mute' mode

HDVS-150 Product Options

- Three-Input Switcher for HDMI and VGA Inputs with HDBaseT Output [model no. **AT-HDVS-150-TX**]
- HDBaseT to HDMI Scaler Receiver with display control [model no. **AT-HDVS-150-RX**]
- Two-Input Wall Plate Switcher for HDMI and VGA Inputs with HDBaseT Output [model no. **AT-HDVS-150-TX-WVP**]
- Blank Face Plate for HDVS Series Wall Plate Switchers [model no. **AT-HDVS-TX-WP-NB**]



[model no. AT-HDVS-150-TX Switcher]



[model no. AT-HDVS-150-RX Receiver]



[model no. AT-HDVS-150-TX-WVP Switcher]



[model no. AT-HDVS-TX-WP-NB Blank Face Plate] (Shown installed on AT-HDVS-150-TX)

Atlona HDVS 200 Series

The HDVS-200 Series is a simple audio visual system with automatic input selection for HDMI and VGA inputs, projector on/off control, analog audio de-embedding, volume control, and a scaler. It is a premium upgrade to the HDVS-150 Series offering functions that enable IP management, and other advanced installation functions including multiple RS-232 ports, a contact closure port for screen control, CEC display control for consumer displays and Ethernet-enabled (100 m) HDBaseT performance. The HDVS-200 Series incorporates many integrator-requested features while still maintaining overall value.

Atlona Advantages

- 3x1 HDBaseT™ SWITCHER** Features two HDMI inputs plus a VGA input with 3.5mm audio connector
- SCALER WITH HDMI OUTPUT AND INPUT RESOLUTION CONTROL** Scales output video signals up to 1080p/60Hz and 1920x1200; Choose preferred input resolution from 800x600 to 1920x1200
- ETHERNET ENABLED, HDBaseT EXTENTION** Receives IP and HDMI signals up to 328 ft (100m) @ 1080p
- ITC/MP AND RS-232 CONTROL** Reduces integration time and costs
- VOLUME CONTROL** Adjust de-embedded audio or display audio
- CONTACT CLOSURE FOR SCREEN OR DISPLAY LIFT CONTROL** Automates screen or lift activation at system power-up; reduces steps for operators

HDVS-200 Product Options

- Three-Input Switcher for HDMI and VGA Inputs with Ethernet-Enabled HDBaseT Output [model no. **AT-HDVS-200-TX**]
- Two-Input Wall Plate Switcher for HDMI and VGA Input with Ethernet-enabled HDBaseT output [model no. **AT-HDVS-200-TX-WP**]
- Ethernet-enabled HDBaseT Scaler with HDMI and Analog Audio Outputs [model no. **AT-HDVS-200-RX**]
- Blank Face Plate for HDVS Series Wall Plate Switchers [model no. **AT-HDVS-TX-WP-NB**]



[model no. AT-HDVS-200-TX Switcher]

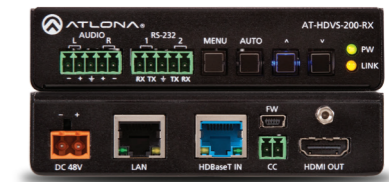

[model no. AT-HDVS-200-RX Scaler]



[model no. AT-HDVS-200-TX-WVP Switcher]



[model no. AT-HDVS-TX-WP-NB Switcher]

Atlona HDVS Switcher/Scaler Series

Small systems designed around HDVS switchers and scalers are perfect for classrooms and small conference rooms. As part of larger and more complex applications these components enable HDMI and VGA/analog audio input to larger switchers. They enable HDBaseT distances on both inputs and outputs, and scaling/de-embedded audio. The RX can be used with any Atlona transmitter, HDCAT or PRO2HD or PRO3HD matrix if a scaler is required on a specific output. Now with automatic display control and automatic input selection, HDCP management and adjustable preferred input resolution!

Atlona Advantages

- INPUTS** HDMI and VGA (plus audio) on a single wall plate
- USE FEWER CABLES** HDMI and VGA/analog audio over a single category cable
- SCALER** HDMI output at receiver scaled to match the resolution of your display
- DE-EMBEDDED AUDIO** available as a balanced output. The HDMI signal going to the display also supports audio
- INPUT SELECT OPTIONS** Auto-select inputs based on last input used, front panel button, or by RS-232 control
- DISPLAY CONTROL OPTIONS** Use the display on/off button at TX wall plate
- MAXIMUM DISTANCE** up to 230 ft (70 m)
- POWER OVER CATEGORY CABLE (PoCC)** requires power only at the receiver
- WORLDWIDE USE** US- and UK- compatible wall plates for global use
- IMAGE CONTROL OPTIONS** Full range of complete image controls including a variety of output resolutions to match your display
- INPUT RESOLUTION** Up to 1920x1200
- USER-FRIENDLY SOFTWARE** RS-232 commands for display control must be programmed with easy-to-use, included software (requires a PC with RS-232 out or with a USB-to-serial converter and basic knowledge of RS-232 command structure)

HDVS Product Options

- Order TX wall plate and RX receiver separately. TX not compatible with other current Atlona extender solutions.
- Atlona HDMI + VGA/Audio HDBaseT Extender Wall Plate w/ Display Control [model no. **AT-HDVS-TX-WP**]
- Atlona HDMI HDBaseT Scaler Receiver [model no. **AT-HDVS-RX**]
- Atlona HDMI (2) and VGA/Audio HDBaseT Extender Switcher w/Display Control [model no. **AT-HDVS-TX**]
- Atlona HDMI + VGA/Audio HDBaseT Extender Wall Plate w/ Display Control [model no. **AT-HDVS-TX-WP-UK**]



[model no. AT-HDVS-TX-WP Transmitter]



[model no. AT-HDVS-RX]

Atlona HDVS Extender Wall Plate

AT-HDVS-TX-WP and AT-HDVS-TX-WP-UK

Components can function as complete input and control within a simpler system. As part of larger and more complex applications these components enable HDMI and VGA/analog audio input to larger switchers. HDVS transmitter wall plate is specifically designed to work with HDVS receiver. RS-232 features require use of both products. Now with Auto Display control, HDCP management and adjustable preferred input resolution!

Atlona Advantages

- MAXIMUM DISTANCE** up to 230 ft (70 m)
- POWER OVER CATEGORY CABLE (PoCC)** requires power from the receiver
- INPUT SELECT OPTIONS** Select inputs automatically (based on last input used), front panel button, or by RS-232 control connected at receiver
- USE FEWER CABLES** HDMI and VGA/analog audio over a single category cable
- DISPLAY CONTROL OPTIONS** Use the display on/off button at TX wall plate (RS-232)
- WORLDWIDE USE** US- and UK-compatible wall plates for global use

HDVS Product Options

- Order TX wall plate and RX receiver separately. TX requires power from compatible switchers, or HDVS.
- Atlona HDMI + VGA/Audio HDBaseT Extender Wall Plate w/ Display Control [model no. **AT-HDVS-TX-WP** or **AT-HDVS-TX-WP-UK**]
- Atlona HDMI HDBaseT Scaler Receiver [model no. **AT-HDVS-RX**]
- Atlona HDMI (2) VGA/Audio HDBaseT Extender Switcher w/ Display Control [model no. **AT-HDVS-TX**]



[model no. AT-HDVS-TX-WP Transmitter]



[model no. AT-HDVS-TX-WP-UK Transmitter]

Atlona HDVS Receiver/Scaler

AT-HDVS-RX

Atlona's HDVS HDBaseT to HDMI receiver offers scaling and audio de-embedding in a single unit for simple installation. Whether the source is the HDVS wall plate, an HDBaseT transmitter, an Atlona HDBaseT distribution amplifier or an Atlona PRO2HD or PRO3HD series matrix switcher, the output is matched to the display it feeds. Complete image adjustment via RS-232 controls or front panel. Now with Auto Display control, HDCP management and adjustable preferred input resolution!

Atlona Advantages

- MAXIMUM DISTANCE** up to 230 ft (70 m)
- POWER OVER CATEGORY CABLE (PoCc)** sends power to matching transmitter HDVS-WP
- DE-EMBEDDED AUDIO** available as a balanced output at AT-HDVS-RX. The HDMI signal going to the display also supports audio
- IMAGE CONTROL OPTIONS** Full range of complete image controls
- INPUT RESOLUTION** up to 1080p, 1920x1200
- OUTPUT RESOLUTIONS** to match your display up to 1080p or 1920x1200

HDVS Product Options

Order TX wall plate and RX receiver separately. TX not compatible with other current Atlona extender solutions.

Atlona HDMI + VGA/Audio HDBaseT Extender Wall Plate w/ Display Control (ships with US + UK wall plates) [model no. **AT-HDVS-TX-WP**]

Atlona HDMI HDBaseT Scaler Receiver [model no. **AT-HDVS-RX**]

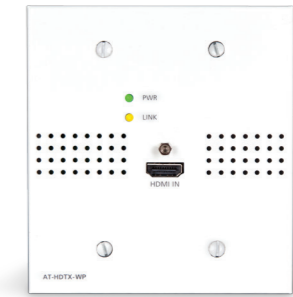

Atlona HDMI (2) and VGA/Audio HDBaseT Extender/Switcher w/Display Control

AT-HDVS-TX

Atlona's HDVS-TX helps to smooth the transition from analog to digital displays, allowing advanced HDMI display devices to be used with the many VGA computers still in use. It allows automatic switching between both HDMI and VGA inputs, digitizes and transmits via HDBaseT. As part of a simple HDVS series AV system it enables projector control. Inputs directly to CLSO-612 HDBaseT inputs!

Atlona Advantages

- ANALOG TO DIGITAL**
- HDBASET AND POWER OVER CATEGORY CABLE (POCC)** allow signal and power to 230 feet (70 meters) over a single category cable
- HDMI AND VGA** up to 1080p/1920x1200
- WORKS BEST** when used with HDVS-RX
- ENABLES PROJECTOR CONTROL** from HDVS-TX
- RS-232** input selection from 3rd party controller
- 3-WAY POWER** PoCc to receiver, PoCc from receiver, and local power supply

Atlona HDMI + VGA/Audio HDBaseT Extender Wall Plate w/Display Control

AT-HDTX-WP AT-HDTX-WP-UK

Atlona's HDTX-WP HDBaseT transmitter wall plate, paired with an Atlona HDVS receiver, allows the use of advanced HDMI display devices with existing VGA computers in simple, complete systems with input switching and control. This attractive wall plate simplifies installation because it can be powered either at the transmitter, from the receiver, or with the PS-POCC when used with HDVS-RX; so no power is needed at the transmitter. Inputs directly to CLSO-612 HDBaseT inputs!

Atlona Advantages

- TRANSMITS HDMI SIGNALS** up to 230 feet (70 meters)
- HDMI UP TO ULTRA HD 4Kx2K**
- US 2-GANG WALL PLATE**
- 3-WAY POWER** PoCc to receiver, PoCc from receiver, or local power supply



Atlona DVI Passive Extender over Category Cable

AT-DVI60SRS

The value extender for longer distances via inexpensive category cable.

Atlona Advantages

LONGER DISTANCES Delivers up to 1920x1200 at 160 ft (50 m) or 180 ft (55 m) at lower resolutions such as 1024x768



Atlona DVI Passive Extender over Category Cable

AT-DVI15SRS

The value extender for great video at moderate distances via inexpensive category cable.

Atlona Advantages

1080P AT 50 FT (15 M) OR 100 FT (30 M) at lower resolutions such as 1280x1024



Atlona VGA w/Audio and RS-232 Extender over Category Cable

AT-VGA-RS300SRS

The extender for high-resolution VGA over extremely long distances.

Atlona Advantages

DELIVERS HIGH-DEFINITION RESOLUTION at Extra Long Range Up to 1920x1200 @ 1000 ft (300 m)

AUDIO OPTIONS 2-channel analog audio on 3.5 mm or S/PDIF digital audio

CONTROL MADE EASY Bi-directional RS-232 control

Atlona Power Over Ethernet Mid-Span Power Supply

The Atlona AT-PS-POE is a 48 VDC power injector designed to send remote power to HDBaseT™ products that operate on IEEE 802.03af Power over Ethernet. When placed within an HDBaseT transmission line, it allows two powered products to work together. The power supply features two power switches to selectively send power up- or down-stream. Both power streams can operate simultaneously. With a

bandwidth of 10.2 Gbps, the power supply supports 4K/UHD resolutions, multi-channel audio formats, and offers full 3-D pass-through.

Atlona Advantages

POWER SUPPLY FOR REMOTE POWERING Industry standard powering scheme for HDBaseT products

MID-SPAN POWER SUPPLY Saves cost by eliminating duplicate devices

SUPPORT 4K/UHD SIGNALS Ideal for ultra-high resolution signals

SWITCHABLE POWER Send power only in the required direction

UPGRADE FOR PoCc SYSTEMS Maintains ROI on legacy systems

Related Products

Atlona HDMI + VGA/Audio HDBaseT Extender Wall Plate w/ Display Control [US model no. **AT-HDVS-TX-WP** or UK model no. **AT-HDVS-TX-WP-UK**]

Atlona HDMI + VGA/Audio HDBaseT Extender Wall Plate w/Display Control [model no. **AT-HDTX-WP**]

Atlona HDBaseT RX HDMI Receiver [model no. **AT-HDRX**]

Atlona HDBaseT RX HDMI Receiver w/IR [model no. **AT-HDRX-IR**]

Atlona HDBaseT RX HDMI Receiver w/Ethernet, RS-232, and IR [model no. **AT-HDRX-RSNET**]



[model no. AT-PS-POE]

AMS READY

Converters and Scalers

Atlona converters and scalers help overcome the inherent compatibility and performance challenges of integrating and connecting various devices and signal formats; and help deliver the best possible performance from AV systems.

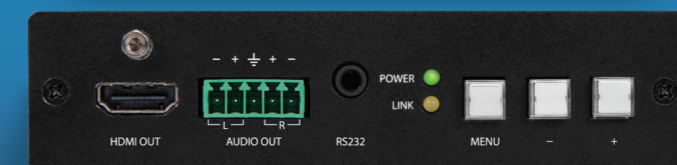

Conversions Made Simple

With the alphabet soup of connectivity standards, resolutions and digital/analog conversions are not just confusing, they create obstacles in system design. Atlona solutions can simplify interchange between these standards. Our scalers enable seamless interchange between sources and displays with disparate resolutions. Our converters help ease the transition from analog to digital.

Convert HDMI and VGA to HDBaseT

Atlona HDVS Extender/Scaler Series

As part of larger and more complex applications these components enable HDMI and VGA/analog audio input to larger switchers. They enable HDBaseT distances on both inputs and outputs and scaling/de-embedded audio. The RX can be used with any Atlona transmitter, HDCAT or PRO2 or PRO3 matrix if a scaler is required on a specific output. Now with Auto Display Control, HDCP management and preferred input resolution selection. HDVS-TX is designed to work with CLSO-612 multi-format switchers.

Atlona Advantages

- INPUTS HDMI AND VGA** (plus audio) on a single wall plate
- USE FEWER CABLES** HDMI and VGA/analog audio over a single category cable
- SCALER** HDMI output at receiver scaled to match the resolution of your display
- DE-EMBEDDED AUDIO** available as a balanced output. The HDMI signal going to the display also supports audio
- INPUT SELECT OPTIONS** Auto-select inputs based on last input used, front panel button, or by RS-232 control
- DISPLAY CONTROL OPTIONS** Use the display on/off button at TX wall plate
- MAXIMUM DISTANCE** up to 230 ft (70 m)
- POWER OVER CATEGORY CABLE (PoC)** requires power only at the receiver
- WORLDWIDE USE** US- and UK- compatible wall plates for global use
- IMAGE CONTROL OPTIONS** Full range of complete image controls including a variety of output resolutions to match your display
- INPUT RESOLUTION** Up to 1920x1200

USER-FRIENDLY SOFTWARE RS-232 commands for display control must be programmed with easy-to-use, included software (requires a PC with RS-232 out or with a USB-to-serial converter and basic knowledge of RS-232 command structure)

HDVS Product Options

Order TX wall plate and RX receiver separately. TX not compatible with other current Atlona extender solutions.
 Atlona HDMI + VGA/Audio HDBaseT Extender Wall Plate w/ Display Control [US model no. [AT-HDVS-TX-WP](#) or UK model no. [AT-HDVS-TX-WP-UK](#)]
 Atlona HDMI HDBaseT Scaler Receiver [model no. [AT-HDVS-RX](#)]
 Atlona Mid-Span Power Supply [model no. [AT-PS-POCC](#)]



[model no. AT-HDVS-TX-WP or model no. AT-HDVS-TX-WP-UK Transmitter]



[model no. AT-HDVS-RX Receiver]

Convert to SDI

Atlona HDMI to SDI Converter

AT-HD-3GSDI
 Easily converts HDMI to SDI without loss in real time.

Atlona Advantages

- CONVERTS** HDMI to 3G-SDI, HD-SDI, and SD-SDI
- AUDIO SUPPORT** 8 channels; 7.1 or 5.1-channel audio
- AUTO-DETECT** offers 3G/HD/SD-SDI auto detection
- HDCP** Does not convert copy-protected sources
- 3G FORMATS** (SMPTE 425M, Level A) Supports 1080p @50/59. 94/60Hz (422), 1080p @24/25/30Hz (444), 1080i @50/59. 94/60Hz (444), 720p @24/25/50/59. 94/60Hz (444).
- HIGH-DEFINITION (HD) FORMATS** Supports 1080i @50/59. 94/60Hz, 1035i @50/59. 94/60Hz, 720p @50/59. 94/60Hz
- STANDARD-DEFINITION (SD) FORMATS** Supports NTSC @59. 94Hz, PAL @50Hz
- DUAL OUTPUT** Offers two, low-jitter SDI outputs



[model no. AT-HD-3GSDI]

Convert to HDMI and DM

Atlona SDI to HDMI Converter w/Analog Audio Output

AT-3GSDI-HD2
 Easily converts SDI video formats to HDMI to make sources and displays compatible. RCA audio outputs make it ideal for external sound systems.

Atlona Advantages

- SYSTEM EXPANDABILITY** SDI output allows both display on local HDMI monitor and SDI feed for recording
- COMPATIBILITY** Works with 3G-SDI, HD-SDI, and SD-SDI
- LOSSLESS CONVERSION** Perfect conversion from digital to digital



[model no. AT-3GSDI-HD2]



Atlona DVI to HDMI Converter w/Analog/Digital Audio to HDMI Converter/Embedder

AT-HD610

Use the AT-HD610 to accurately embed analog or digital audio to a DVI signal for input to an HDMI switch or monitor

Atlona Advantages

Audio Support Embeds digital or analog audio with DVI video onto HDMI

Audio Jacks Has S/PDIF or 3.5 mm stereo inputs

EDID Learns the EDID from connected display to ensure compatible installation.



Atlona Composite Video and Stereo Audio to HDMI Converter/Scaler

AT-HD120

Our value-priced composite video converter offers the same engineering as AT-HD520, optimized for systems that don't require S-video input or image enhancement.

Atlona Advantages

PLUG AND PLAY Combine a composite video (BNC) signal and stereo audio signal into a signal that passes over a single HDMI cable



Atlona Composite or S-Video to VGA/Component Converter/Scaler

AT-AVS100

The converter and scaler for analog formats, it simplifies switching when mixing composite/S-video sources with displays that support only VGA/component signals.

Atlona Advantages

MULTI-REGION CONVERSION Supports a variety of sources with NTSC (480i) or PAL(576i)



Convert to VGA and Component Video

Atlona HDMI to VGA/Component and Analog Audio Converter

AT-HD420

Converts HDMI to VGA. Not HDCP compliant – doesn't support pre-recorded HDMI sources such as Blu-ray and set-top boxes.

Atlona Advantages

AUDIO DE-EMBEDDING De-embeds PCM audio from HDMI to 2-channel audio on a 3.5 mm jack

DIGITAL TO ANALOG CONVERSION Allows use of HDMI sources with analog displays



Atlona HDMI to Composite and S-Video Down-Converter

AT-HD530

The solution for spaces with older displays—allows the continued use of older composite/S-video displays with new HDMI and DVI sources. It's perfect for images from HDMI cameras.

Atlona Advantages

MULTI-REGION CONVERSION Supports a variety of sources with PAL or NTSC displays

NOTE Not HDCP compliant and won't function with standard HDMI sources such as Blu-rays and set-top boxes

Audio

Atlona audio solutions are purpose-built to satisfy the unique requirements of integrating and delivering high-performance audio signal distribution, conversion and amplification in residential and commercial AV systems.

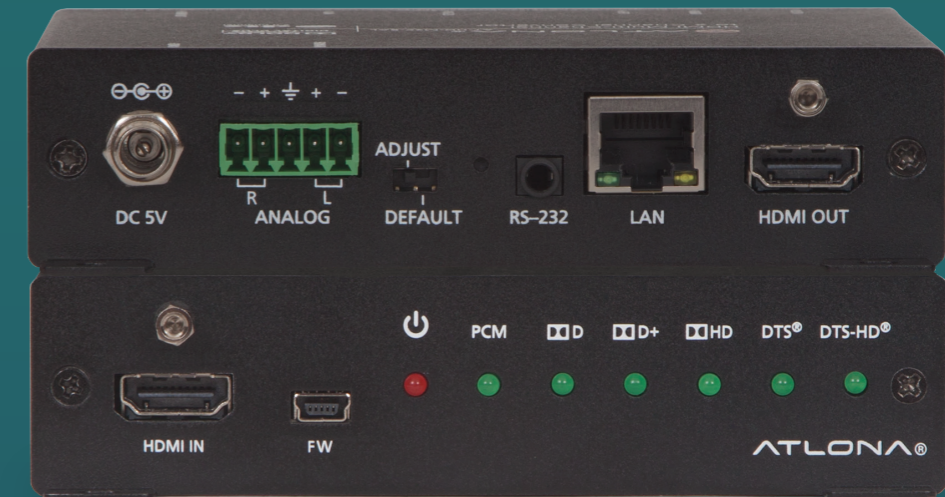

The Universal HDMI Audio De-embedder

The Atlona AT-UHD-M2C-BAL is an audio converter used to extract and downmix multi-channel digital Dolby® and DTS® surround sound signals from HDMI sources to balanced analog signals for professional audio systems. The converter provides controls for one- or two-channel mode, volume, mute, bass, and treble via RS-232, TCP/IP and a web-based GUI. A balanced analog audio output is provided on a 5-pin captive screw connector. The video pass-through design of the AT-UHD-M2C-BAL allows it to be placed anywhere in the signal path where a convenient audio feed to the sound system is required.



AMS READY

4K/UHD HDMI Multi-Channel Digital to Two-Channel Balanced Analog Audio Converter

AT-UHD-M2C-BAL

In commercial applications where audio is provided by an HDMI source, integrators need an easy solution to extract balanced, +4 dBu, two-channel or monaural audio for professional sound reinforcement systems while maintaining full 4K/UHD video signal integrity for video switching and distribution systems. Integrated control reduces total cost in simple systems potentially eliminating a DSP or other volume control device.

Atlona Advantages

UNIVERSAL DE-EMBEDDER FOR DOLBY AND DTS SIGNALS

Allows any multi-channel audio stream to be used within a professional audio system

DOWNMIXES MULTI-CHANNEL AUDIO TO 1 OR 2-CHANNEL AUDIO Provides easy integration of HDMI audio sources into professional audio systems

BALANCED AUDIO OUTPUT Allows for fast and proper integration with professional sound systems
INDICATOR LIGHTS Uses LED indicators to identify the incoming audio format.

VOLUME AND EQ ADJUSTMENT Audio adjustment without external DSP

4K/UHD SUPPORT Ensures all high-resolution signals are passed to video system

CONTROL CAPABILITIES Easy interface to control systems for simplified audio system adjustments

DEFAULT SWITCH Provides quick troubleshooting adjustment when control systems are not available



Atlona HDMI Multi-Channel to 2-Channel Audio Converter

AT-HD-M2C

Atlona's M2C provides audio compatibility between zones for multi-zone AV systems. Many displays prevent the highest quality audio from being sent from Blu-rays, set-top boxes or game consoles because they won't accept Dolby and DTS. Your matrix switcher or distribution amplifier simply repeats those 2 channel EDIDs back to the source.

With Atlona's M2C, the 2-Channel EDID is converted to a full-featured EDID so that areas that can handle Lossless 7.1 and 5.1 actually receive those signals. In addition, 2 channel output is down-mixed from the multi-channel signal and output in HDMI, S/PDIF, TosLink and Analog (RCA) formats.

Atlona Advantages

DOLBY AND DTS SUPPORT Converts audio such as DTS Digital and Dolby Digital 5.1, Dolby Digital Plus, DTS-HD Master Audio, and Dolby TrueHD into 2-channel.

EDID MADE EASY Replaces display's 2-channel EDID with its own multi-channel EDID ensuring that all sources on a matrix switch will always output multi-channel audio.

OUTPUT CONNECTORS Features HDMI (video + 2-channel audio) output, S/PDIF and TosLink digital audio, and RCA analog audio.

INDICATOR LIGHTS Uses LED indicators to identify the incoming audio format.



Atlona HDMI Audio De-Embedder w/3D

AT-HD570

Our audio de-embedder separates audio from HDMI to TosLink and 3.5 mm jacks.

Atlona Advantages

DIGITAL OUTPUTS Transmits up to multi-channel DTS 5.1 and Dolby Digital signals

ANALOG OUTPUTS Transmits up to 7.1 uncompressed LPCM multi-channel via four 3.5 mm jacks



Atlona Stereo/Mono Audio Amplifier

AT-PA100-G2

An affordable, efficient class D amplifier that uses less energy and creates less heat. Powerful functionality in a small form factor that's just right for limited space. Uses less power than more elaborate amplifiers but can be easily hidden behind a display.

Atlona Advantages

INTEGRATION-READY CONTROL

Complete control via RS-232, IR, and front-mounted control panel

20 WATTS per channel

MIC INPUT Layers voice input over program audio using a microphone input compatible with condenser, dynamic, or wireless microphones

SUPER COMPACT Fits easily in smaller spaces

MOUNTING EARS included

OPTIONAL IR REMOTE CONTROL KIT for input channel, mute, mic control, volume, and EQ

OUTPUT CONNECTOR captive screw speaker connector

INPUT CONNECTORS 1 x captive screw mic, 2 x RCA, 1 x 3.5 mm

Related Product

Atlona Remote Control Kit [model no. AT-PA1-IR-G2]



Atlona Optical/Coaxial Digital Converter

AT-AD2

Converts and extends TosLink (optical) to S/PDIF (coax) or S/PDIF to TosLink digital audio.

Atlona Advantages

LOOP OUT Outputs both TosLink and S/PDIF regardless of input format

Test Equipment

Atlona test kits make it easy to identify, diagnose, and remedy connectivity and compatibility issues in the field.



Identify, Diagnose, and Remedy

Atlona test and troubleshooting solutions save integrators and installers cost and labor. Complex installations can be overwhelming, but with our all-in-one installation test kit, troubleshooting couldn't be easier.

Atlona Installation Test Kit

KIT-PROHD3

We've assembled our best and most popular HDMI diagnostic equipment in a high-quality water-resistant case for easy transport. All our test devices are also available for individual purchase.

Kit Includes

- PORTABLE HDMI Signal Generator [model no. AT-HD800]
- 4K HDMI EMULATOR/TESTER [model no. AT-UHD-SYNC]
- 7-INCH PRO HD MONITOR w/HDMI, VGA and Component Inputs [model no. AT-DIS7-PROHD]
- 4-HOUR PORTABLE BATTERY for use w/AT-DIS7-PROHD [model no. AT-BAT-DIS7PRO]
- CARRYING CASE



Atlona 7-Inch PRO HD Monitor
w/HDMI, VGA and Component Inputs

AT-DIS7-PROHD

Our PROHD monitor displays video signals and test patterns for easy troubleshooting, and outputs audio from speakers. It emulates displays without actually using the display to confirm the proper operation of switching and cabling.

Atlona Advantages

VIDEO AND CABLE TESTING DISPLAYS signals with resolutions from 480i up to 1080p (640x480 to 1920x1200)

EASILY RACK-MOUNTABLE Installs permanently with optional rack mount

DISPLAYS COMPONENT SIGNALS with supplied break-out cable

AUDIO SPEAKERS to check for embedded audio

Related Products

Atlona 4-Hour Portable Battery [model no. AT-BAT-DIS7PRO]



Atlona 4K HDMI Emulator/Tester

AT-UHD-SYNC

The Atlona AT-UHD-SYNC is designed to analyze errors, identify issues and restore failed HDMI signals.

Atlona Advantages

4K (UHD) SUPPORT Ensures the best video performance

5 VOLT/HPD EMULATION Restores AV signals due to faulty cables or when multiple distribution devices are cascaded

EDID EMULATION 9 unique stored files plus learning capability to ensure the best picture and sound is achieved

3 LEDs: INDICATORS HPD, 5V, HDCP indicators aid in HDMI signal failure analysis.

SIGNAL REGENERATION HDMI 1.2 sources can be reliably transmitted with HDBaseT extenders.

USB POWER No wall power supply required! Harvest power from local USB devices to power UHD-SYNC when an AC outlet isn't available.

Palm sized form factor reduces impact within confined spaces.



Atlona Portable HDMI Signal Generator

AT-HD800

Our signal generator makes it easy to diagnose incompatibilities in the field. An EDID reading function simplifies diagnosis, and optional USB power adds flexibility.

Atlona Advantages

GENERATES 13 TEST SIGNALS with resolutions from 480i (including 576i/p) to 1080p at 50Hz and 60Hz, as well as 1080p at 24Hz. Includes three common modes of 3D testing. Not all patterns available at all resolutions

PORTABLE DESIGN Small size, battery power, and an included protective rubber jacket

Cables and Adapters

Atlona cables and adapters are precision-engineered to maximize signal reliability and integrity and are available in a wide variety of formats, lengths and configurations that have been optimized for system integrators and installers.



Atlona LinkConnect Captive Screw Cable Series

Atlona's captive screw cable series features a thoughtful modification that installers and integrators asked for: pre-stripped cables that reduce excess cable lengths. This series features connections designed for use with captive screw connectors, pre-stripped at the opposite ends so they can be easily inserted for more secure, direct contact with the conductor.



Atlona LinkConnect Captive Screw 2-Channel Audio Cable

AT-LC-CS-2CH-2M

High-performance cables with support for 2-channel audio, designed for use with captive screw connectors and pre-stripped at the opposite ends so they can be easily inserted for more secure contact with the conductor.

Atlona LinkConnect Captive Screw IR Cable

AT-LC-CS-IR-2M

High-performance cables with support for IR control, designed for use with captive screw connectors and pre-stripped at the opposite ends so they can be easily inserted for more secure contact with the conductor.

Get CONNECTED

For more information about products featured in this catalog or any of Atlona's award-winning solutions, visit atlona.com.

Contact your Atlona representative by calling
+1.408.962.0515 (U.S.).
+1.877.536.3976 (U.S. toll free)
+41.43.508.4321 (International).



US: +1.408.962.0515 US Toll Free: +1.877.536.3976 International: +41.43.508.4321
www.atlona.com