

## Matrix Switchers

# CrossPoint 450 Plus Series

# CrossPoint Ultra Series

# MAV Plus Series

Matrix Switchers



**Extron Electronics**  
INTERFACING, SWITCHING AND CONTROL

# Safety Instructions

## Safety Instructions • English

**WARNING:** This symbol, ⚠, when used on the product, is intended to alert the user of the presence of uninsulated dangerous voltage within the product's enclosure that may present a risk of electric shock.

**ATTENTION:** This symbol, ⚠, when used on the product, is intended to alert the user of important operating and maintenance (servicing) instructions in the literature provided with the equipment.

For information on safety guidelines, regulatory compliances, EMI/EMF compatibility, accessibility, and related topics, see the Extron Safety and Regulatory Compliance Guide, part number 68-290-01, on the Extron website, [www.extron.com](http://www.extron.com).

## Instructions de sécurité • Français

**AVERTISSEMENT :** Ce pictogramme, ⚠, lorsqu'il est utilisé sur le produit, signale à l'utilisateur la présence à l'intérieur du boîtier du produit d'une tension électrique dangereuse susceptible de provoquer un choc électrique.

**ATTENTION :** Ce pictogramme, ⚠, lorsqu'il est utilisé sur le produit, signale à l'utilisateur des instructions d'utilisation ou de maintenance importantes qui se trouvent dans la documentation fournie avec le matériel.

Pour en savoir plus sur les règles de sécurité, la conformité à la réglementation, la compatibilité EMI/EMF, l'accessibilité, et autres sujets connexes, lisez les informations de sécurité et de conformité Extron, réf. 68-290-01, sur le site Extron, [www.extron.com](http://www.extron.com).

## Sicherheitsanweisungen • Deutsch

**WARNUNG:** Dieses Symbol ⚠ auf dem Produkt soll den Benutzer darauf aufmerksam machen, dass im Inneren des Gehäuses dieses Produktes gefährliche Spannungen herrschen, die nicht isoliert sind und die einen elektrischen Schlag verursachen können.

**VORSICHT:** Dieses Symbol ⚠ auf dem Produkt soll dem Benutzer in der im Lieferumfang enthaltenen Dokumentation besonders wichtige Hinweise zur Bedienung und Wartung (Instandhaltung) geben.

Weitere Informationen über die Sicherheitsrichtlinien, Produkthandhabung, EMI/EMF-Kompatibilität, Zugänglichkeit und verwandte Themen finden Sie in den Extron-Richtlinien für Sicherheit und Handhabung (Artikelnummer 68-290-01) auf der Extron-Website, [www.extron.com](http://www.extron.com).

## Instrucciones de seguridad • Español

**ADVERTENCIA:** Este símbolo, ⚠, cuando se utiliza en el producto, avisa al usuario de la presencia de voltaje peligroso sin aislar dentro del producto, lo que puede representar un riesgo de descarga eléctrica.

**ATENCIÓN:** Este símbolo, ⚠, cuando se utiliza en el producto, avisa al usuario de la presencia de importantes instrucciones de uso y mantenimiento recogidas en la documentación proporcionada con el equipo.

Para obtener información sobre directrices de seguridad, cumplimiento de normativas, compatibilidad electromagnética, accesibilidad y temas relacionados, consulte la Guía de cumplimiento de normativas y seguridad de Extron, referencia 68-290-01, en el sitio Web de Extron, [www.extron.com](http://www.extron.com).

## Инструкция по технике безопасности • Русский

**ПРЕДУПРЕЖДЕНИЕ:** Данный символ, ⚠, если указан на продукте, предупреждает пользователя о наличии неизолированного опасного напряжения внутри корпуса продукта, которое может привести к поражению электрическим током.

**ВНИМАНИЕ:** Данный символ, ⚠, если указан на продукте, предупреждает пользователя о наличии важных инструкций по эксплуатации и обслуживанию в руководстве, прилагаемом к данному оборудованию.

Для получения информации о правилах техники безопасности, соблюдении нормативных требований, электромагнитной совместимости (ЭМП/ЭДС), возможности доступа и других вопросах см. руководство по безопасности и соблюдению нормативных требований Extron на сайте Extron: [www.extron.com](http://www.extron.com), номер по каталогу - 68-290-01.

## Chinese Simplified (简体中文)

**警告:** ⚠ 产品上的这个标志意在警告用户该产品机壳内有暴露的危险电压, 有触电危险。

**注意:** ⚠ 产品上的这个标志意在提示用户设备随附的用户手册中有重要的操作和维护(维修)说明。

关于我们产品的安全指南、遵循的规范、EMI/EMF 的兼容性、无障碍使用的特性等相关内容, 敬请访问 Extron 网站 [www.extron.com](http://www.extron.com), 参见 Extron 安全规范指南, 产品编号 68-290-01。

## Chinese Traditional (繁體中文)

**警告:** ⚠ 若產品上使用此符號, 是為了提醒使用者, 產品機殼內存在著可能會導致觸電之風險的未絕緣危險電壓。

**注意:** ⚠ 若產品上使用此符號, 是為了提醒使用者, 設備隨附的用戶手冊中有重要的操作和維護(維修)說明。

有關安全性指導方針、法規遵守、EMI/EMF 相容性、存取範圍和相關主題的詳細資訊, 請瀏覽 Extron 網站: [www.extron.com](http://www.extron.com), 然後參閱《Extron 安全性與法規遵守手冊》, 準則編號 68-290-01。

## Japanese

**警告:** この記号 ⚠ が製品上に表示されている場合は、筐体内に絶緣されていない高電圧が流れ、感電の危険があることを示しています。

**注意:** この記号 ⚠ が製品上に表示されている場合は、本機の取扱説明書に記載されている重要な操作と保守(整備)の指示についてユーザーの注意を喚起するものです。

安全上のご注意、法規遵守、EMI/EMF適合性、その他の関連項目については、エクストロンのウェブサイト [www.extron.com](http://www.extron.com) より『Extron Safety and Regulatory Compliance Guide』(P/N 68-290-01) をご覧ください。

## Korean

**경고:** 이 기호 ⚠ 가 제품에 사용될 경우, 제품의 인클로저 내에 있는 접지되지 않은 위험한 전류로 인해 사용자가 감전될 위험이 있음을 경고합니다.

**주의:** 이 기호 ⚠ 가 제품에 사용될 경우, 장비와 함께 제공된 책자에 나와 있는 주요 운영 및 유지보수(정비) 지침을 경고합니다.

안전 가이드라인, 규제 준수, EMI/EMF 호환성, 접근성, 그리고 관련 항목에 대한 자세한 내용은 Extron 웹 사이트([www.extron.com](http://www.extron.com))의 Extron 안전 및 규제 준수 안내서, 68-290-01 조항을 참조하십시오.

## FCC Class A Notice

This equipment has been tested and found to comply with the limits for a Class A digital device, pursuant to part 15 of the FCC rules. The Class A limits provide reasonable protection against harmful interference when the equipment is operated in a commercial environment. This equipment generates, uses, and can radiate radio frequency energy and, if not installed and used in accordance with the instruction manual, may cause harmful interference to radio communications. Operation of this equipment in a residential area is likely to cause interference. This interference must be corrected at the expense of the user.

### ATTENTION:

- The Twisted Pair Extension technology works with unshielded twisted pair (UTP) or shielded twisted pair (STP) cables. To ensure FCC Class A and CE compliance, STP cables and STP connectors are required.
- La technologie extension paires torsadées fonctionne avec les câbles paires torsadées blindées (UTP) ou non blindées (STP). Afin de s'assurer de la compatibilité entre FCC Classe A et CE, les câbles STP et les connecteurs STP sont nécessaires.

### NOTE:

- For more information on safety guidelines, regulatory compliances, EMI/EMF compatibility, accessibility, and related topics, see the "[Extron Safety and Regulatory Compliance Guide](#)" on the Extron website.
- Pour plus d'informations sur les directives de sécurité, les conformités de régulation, la compatibilité EMI/EMF, l'accessibilité, et les sujets en lien, consultez le « [Informations de sécurité et de conformité Extron](#) » sur le site internet d'Extron.

### Copyright

© 2015 Extron Electronics. All rights reserved.

### Trademarks

All trademarks mentioned in this guide are the properties of their respective owners.

**The following registered trademarks<sup>®</sup>, registered service marks<sup>(SM)</sup>, and trademarks<sup>(TM)</sup> are the property of RGB Systems, Inc. or Extron Electronics:**

Registered Trademarks <sup>(®)</sup>
AVTrac, Cable Cubby, CrossPoint, eBUS, EDID Manager, EDID Minder, Extron, Flat Field, GlobalViewer, Hideaway, Inline, IP Intercom, IP Link, Key Minder, LockIt, MediaLink, PlenumVault, PoleVault, PowerCage, Pure3, Quantum, SoundField, SpeedMount, SpeedSwitch, System <i>INTEGRATOR</i> , TeamWork, TouchLink, V-Lock, VersaTools, VN-Matrix, VoiceLift, WallVault, WindoWall, XTP, and XTP Systems
<b>Registered Service Mark<sup>(SM)</sup> :</b> S3 Service Support Solutions
Trademarks <sup>(TM)</sup>
AAP, AFL (Accu-Rate Frame Lock), ADSP (Advanced Digital Sync Processing), Auto-Image, CableCover, CDRS (Class D Ripple Suppression), DDS (Digital Display Sync Processing), DMI (Dynamic Motion Interpolation), Driver Configurator, DSP Configurator, DSVP (Digital Sync Validation Processing), DTP, eLink, EQIP, FastBite, FlexOS, FOX, FOXBOX, Global Configurator, IP Intercom HelpDesk, LinkLicense, MAAP, MicroDigital, NetPA, ProDSP, QS-FPC (QuickSwitch Front Panel Controller), Room Agent, Scope-Trigger, ShareLink, SIS (Simple Instruction Set), Skew-Free, SpeedNav, Triple-Action Switching, WebShare. XTRA, ZipCaddy, ZipClip

## Conventions Used in this Guide

### Notifications

The following notifications are used:

**WARNING:** A warning indicates a situation that has the potential to result in death or severe injury.

**ATTENTION:** Attention indicates a situation that may damage or destroy the product or associated equipment.

**NOTE:** A note draws attention to important information.

**TIP:** A tip provides a suggestion to make working with the application easier.

### Software Commands

Commands are written in the fonts shown here:

```
^ARMerge Scene , ,Op1 scene 1 , 1 ^B 51 ^W ^C  
[ 01 ] R 0004 00300 00400 00800 00600 [ 02 ] 35 [ 17 ] [ 03 ]
```

```
Esc X14 * X19 * X28 * X31 * X29 CE ←
```

**NOTE:** For commands and examples of computer or device responses mentioned in this guide, the character “0” is used for the number zero and “O” represents the capital letter “o.”

Computer responses and directory paths that do not have variables are written in the font shown here:

```
Reply from 208.132.180.48: bytes=32 times=2ms TTL=32
```

```
C:\Program Files\Extron
```

Variables are written in slanted form as shown here:

```
ping xxx.xxx.xxx.xxx -t
```

```
SOH R Data STX Command ETB ETX
```

Selectable items, such as menu names, menu options, buttons, tabs, and field names are written in the font shown here:

From the **File** menu, select **New**.

Click the **OK** button.

## Specifications Availability

Product specification are available on the Extron website, [www.extron.com](http://www.extron.com).

# Contents

---

## Introduction..... 1

About this Guide.....	1
About the Crosspoint and MAV	
Matrix Switchers.....	1
CrossPoint Ultra Switchers .....	5
CrossPoint 450 Plus Switchers.....	6
MAV Plus Switchers.....	6
Definitions.....	8
Features .....	8

---

## Installation..... 12

Setup and Installation Checklist .....	12
Rear Panel Views.....	13
CrossPoint 450 Plus Switchers.....	14
CrossPoint Ultra Switchers .....	15
MAV Plus Switchers.....	16
Rear Panel Connections .....	19
Video Input and Output (Video Models).....	19
Sync Termination Switches (CrossPoint) ....	23
Audio Input and Output (Audio Models) .....	24
RS-232/RS-422 .....	26
Ethernet.....	27
Reset Button .....	28
External Sync (MAV Plus Video Models).....	28
Power.....	29
Front Panel Configuration Port	
(All Matrix Sizes up to 1616, and	
MAV Plus 248A and MAV Plus 328A Only)....	30

---

## Operation .....31

Front Panel Controls and Indicators.....	31
Input and Output Buttons .....	34
Control Buttons .....	36
I/O Controls .....	38
Power LEDs (2412 and Larger	
Models Only) .....	39
Button Icons.....	39
Front Panel Operations .....	40
Definitions.....	40
Power.....	41
Front Panel Security Lockouts .....	41
Creating a Configuration .....	42
Viewing the Configuration .....	47
I/O Grouping.....	51

Setting RGB delay	
(CrossPoint switchers) .....	55
Using Presets .....	57
Muting and Unmuting Video and Audio	
Outputs .....	60
Viewing and Adjusting the Input	
Audio Level (Audio Models).....	63
Viewing and Adjusting the Analog	
Output Volume (Audio Models) .....	68
Setting the Front Panel Locks	
(Executive Modes) .....	75
Performing a System Reset from the	
Front Panel.....	76
Background Illumination.....	77
Selecting the Rear Panel Remote Port	
Protocol and Baud Rate .....	77
Rear Panel Operations.....	78
Performing Soft System Resets	
(Resets 3, 4, and 5) — CrossPoint Ultra	
and MAV Plus 88, 128, 816, 164, 168,	
1212, 1616, 248, and 328 Matrix Sizes ....	80
Performing Soft Resets —	
CrossPoint 450 Plus and MAV Plus 2412,	
2424, 3216, and 3232 Matrix Sizes .....	81
Performing a Hard Reset — All Models.....	82
Optimizing the Audio (Audio Models) .....	83
Troubleshooting .....	83
Plasma Display S-video Problem	
(CrossPoint Switchers).....	83
Configuration Worksheets.....	84
Worksheet Example 1:	
System Equipment .....	84
Worksheet Example 2:	
Daily Configuration.....	85
Worksheet Example 3:	
Test Configuration.....	86
32-button switchers configuration	
worksheet.....	87
16-button switchers configuration	
worksheet.....	88

---

**Programming Guide ..... 89**

Serial Ports.....	90
Rear Panel RS-232/RS-422 Port .....	90
Front Panel Configuration Port.....	90
Ethernet (LAN) Port.....	90
Default IP Addresses .....	91
Establishing a Connection.....	91
Connection Timeouts .....	91
Number of Connections.....	91
Using Verbose Mode .....	92
Host-to-Switcher Instructions .....	92
Switcher-initiated Messages .....	92
Switcher Error Responses .....	93
Using the Command and Response Tables ...	94
Command and Response Table for	
SIS Commands .....	94
Command and Response Table for	
IP- and Remote Port Specific SIS	
Commands .....	107
Special Characters .....	109

---

**Matrix Software ..... 110**

Matrix Switchers Control Program .....	110
Software Operation via Ethernet .....	110
Software Operation via a Serial Port.....	111
Installing the Software.....	111
Using the Matrix Switcher Control	
Software.....	112
Updating the Firmware .....	119
Uploading HTML files.....	123
Windows Buttons, Drop Boxes, and	
Trash Can.....	124
Windows Menus.....	124
Using Emulation Mode.....	127
Using the Help System .....	128
Button-Label Generator Program.....	129
Installing the Button Label Generator	
Software.....	129
Using the Button-Label Generator	
Software.....	130

---

**HTML Operation ..... 131**

Download the Startup Page.....	132
Status Tab .....	133
System Status Page .....	133
DSVP Page (CrossPoint Switchers).....	134
Configuration Tab .....	134
System Settings Page .....	134
Passwords Page.....	137
Email Settings Page.....	138
File Management Tab .....	141
File Management Page .....	141
Control Tab.....	142
Set and View Ties page.....	142
RGB and Audio Settings Page.....	143
Global Presets Page .....	148

---

**Ethernet Connection ..... 149**

Ethernet Link .....	149
Ethernet Connection.....	149
Default IP Address .....	149
Pinging to Determine	
the Extron IP Address.....	150
Pinging to Determine	
the Web IP Address.....	150
Configuring the CrossPoint or	
MAV Plus Switcher for Network	
Use via the ARP Command .....	151
Connecting as a Telnet Client.....	152
Telnet Tips .....	152
Subnetting — A Primer.....	154
Gateways .....	154
Analog and Remote Devices.....	154
IP Addresses and Octets .....	154
Subnet Masks and Octets .....	155
Determining Whether Devices Are	
on the Same Subnet.....	155

---

**Reference Information ..... 156**

Mounting the Switcher.....	156
UL Guidelines .....	157
Mounting Instructions .....	157
Removing and Installing Button Labels .....	158
Making Labels from Paper Templates .....	158
Installing Labels in the Buttons.....	158

# Introduction

- [About this Guide](#)
- [About the CrossPoint and MAV Matrix Switchers](#)
- [Definitions](#)
- [Features](#)

## About this Guide

This guide contains installation, configuration, and operating information for the complete Extron family of full-function, medium- and large-sized, analog video matrix switchers, specifically:

- CrossPoint 450 Plus large (matrix sizes from 24 inputs by 12 outputs to up to 32 inputs by 32 outputs) ultra-wideband RGBHV and audio matrix switchers
- CrossPoint Ultra small (matrix sizes 16 inputs by 16 outputs and smaller) ultra-wideband RGBHV and audio matrix switchers
- MAV Plus broadcast quality HDTV/component video, S-video, and composite video and audio matrix switchers

## About the Crosspoint and MAV Matrix Switchers

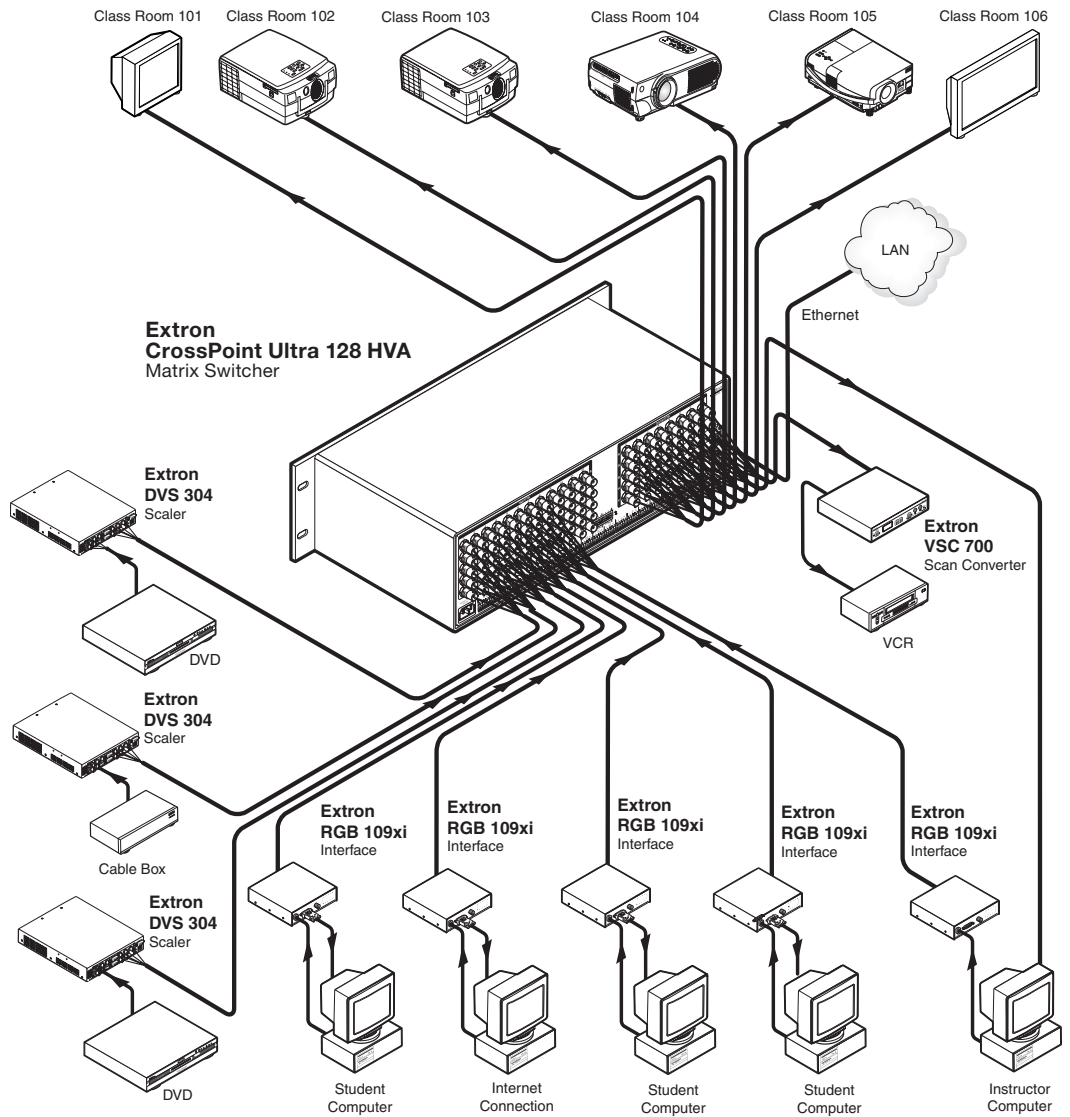
Matrix switchers distribute any input to any combination of outputs. The matrix switchers can route multiple input/output configurations simultaneously.

The matrix switchers are single box solutions to complex wideband (CrossPoint 450 Plus and CrossPoint Ultra, see [figure 1](#) on the next page) or low resolution (MAV Plus, see [figure 2](#), on the next page) video and audio routing applications. Each input and output is individually isolated and buffered, and any input(s) can be switched to any one or all outputs with virtually no crosstalk or signal noise between channels.

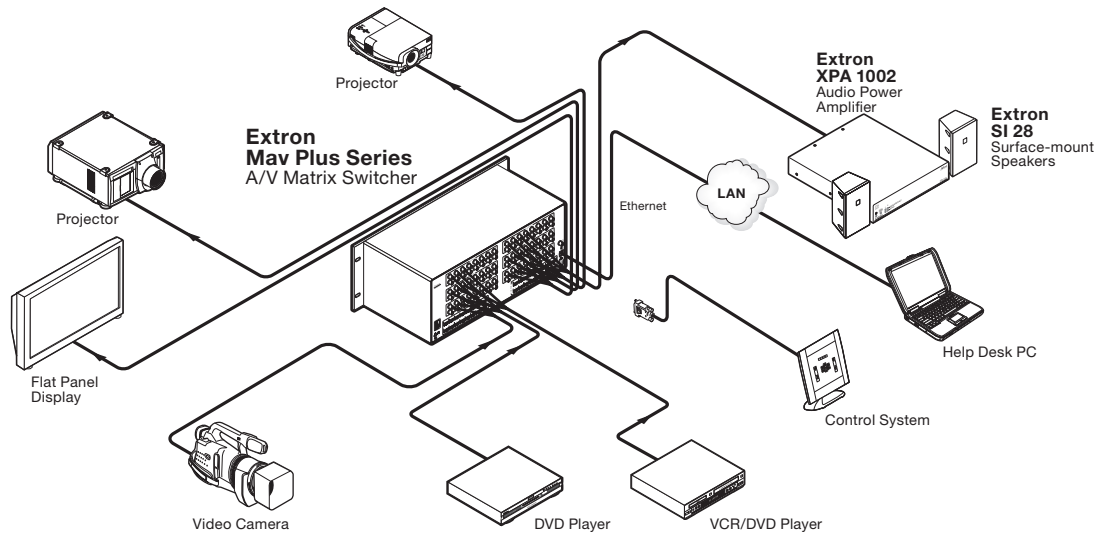
All of the matrix switchers are available in a variety of matrix sizes (the matrix size is the number of inputs and outputs).

CrossPoint 450 Plus and CrossPoint Ultra series switchers offer two models of each matrix size:

- HVA for switching RGBHV video and two-channel stereo audio
- HV for switching RGBHV video signals only



**Figure 1. Typical CrossPoint Ultra Matrix Switcher Application**



**Figure 2. Typical MAV Plus Matrix Switcher Application**



MAV Plus series switchers offer multiple models of all matrix sizes, with one, two, or three (MAV Plus 1616 and smaller) video planes, to support different low resolution video formats (exceptions are noted in **MAV Plus Switchers** on page 6):

- HDA for switching component/HDTV video and two-channel stereo audio
- HD for switching component/HDTV video signals only
- SVA for switching S-video and two-channel stereo audio
- SV for switching S-video signals only
- AV for switching composite video and two-channel stereo audio
- V for switching composite video signals only
- A for switching two-channel stereo audio only

**NOTES:**

- “Video model” refers to any switcher model that switches video.
- “Audio model” refers to any switcher model that switches audio.
- When “450 Plus” or “Ultra” is not specified, “CrossPoint” refers to either model.

All audio models, with the exception of the MAV Plus 128 AV RCA, input and output audio on 3.5 mm, 5-pole captive screw terminals. The MAV Plus 128 AV RCA inputs and outputs audio on RCA connectors.

For all switchers with video and audio, the audio switching can either be linked with the video (audio follow) or independent of the video (audio breakaway).

Adjustable input audio gain and attenuation compensates for level differences between audio inputs.

Each matrix switcher can be remotely controlled via its Ethernet port, its rear panel RS-232/RS-422 port, or its front panel Configuration (RS-232) port (MAV Plus matrix sizes up to 1616, MAV Plus 248 A, MAV Plus 328 A, and CrossPoint Ultra only). The matrix switchers are programmed with the Extron Simple Instruction Set (SIS), a set of basic ASCII code commands that provide simple control through a control system or PC without programming long, obscure strings of code. SIS commands can be entered via either the Ethernet link or either serial link.

The Ethernet port can be connected through a local area network (LAN) or wide area network (WAN).

All models feature e-mail notification of maintenance or other concerned personnel concerning the status of the power supplies and fans and the loss or resumption of sync on individual inputs.

The matrix switchers can be remotely controlled via their rear panel Remote RS-232/RS-422 ports, their rear panel LAN port, and their front panel Configuration port by any of the following:

- A control system
- A PC
- An Extron MKP 2000 remote control panel
- An Extron MKP 3000 remote control panel
- **(RS-232/RS-422 only)** An Extron MCP 1000 remote control panel
- **(RS-232/RS-422 only)** An Extron MKP 1000 remote keypad

The matrix switchers are housed in rack-mountable, metal enclosures with 19" rack ears. The amount of vertical rack space required for each switcher is as follows:

- 2U high enclosure
  - MAV Plus 84, 88, 124, and 128 HDA, HD, SVA, and SV switchers
  - MAV Plus 84, 88, 124, 128, 816, 164 (audio only), 168, 1212, and 1616 AV, AV RCA, V, and A switchers
- 3U high enclosure
  - CrossPoint 84, 88, and 128 HV and HVA switchers
  - MAV Plus 168, 1212, and 1616 SVA and SV switchers
  - MAV Plus 328 and 248 A switchers
- 4U high enclosure
  - MAV Plus 168, 816, and 1616 HDA and HD switchers
- 5U high enclosure
  - MAV Plus 2412, 2424, 3216, and 3232 SV, AV, V, and A switchers
- 6U high enclosure
  - CrossPoint 168, and 1212, 1616 HV and HVA switchers
- 8U high enclosure
  - CrossPoint 450 Plus 2412 and 2424 HV and HVA switchers
  - MAV Plus 2412, 2424, 3216, and 3232 SVA switchers
- 10U high enclosure
  - CrossPoint 450 Plus 3216 and 3232 HV and HVA switchers

The appropriate rack mounting kit is included with each switcher.

Each model has an internal 100 VAC to 240 VAC, 50/60 Hz, switching power supply that provides worldwide power compatibility. The CrossPoint 450 Plus 2412, 2424, 3216, and 3232 and MAV Plus 2412, 2424, 3216, and 3232 each have two, primary and redundant, power supplies. The power ratings of the power supplies for the various switchers are as follows:

- 20 watts
  - MAV Plus 128 AV RCA
  - MAV Plus 88 and 128
- 30 watts
  - CrossPoint 84, 88, and 128
  - MAV Plus 816, 168, 1212, and 1616
  - MAV Plus 164 A
- 36 watts
  - CrossPoint 168, 1212, and 1616
- 48 watts
  - MAV Plus 328 A
  - MAV Plus 248 A
- 100 watts
  - MAV Plus 2412 and 3216
- 120 watts
  - MAV Plus 2424 and 3232
- 150 watts
  - CrossPoint 450 Plus 2412 and 3216
- 180 watts
  - CrossPoint 450 Plus 2424 and 3232

## CrossPoint Ultra Switchers

There are six CrossPoint Ultra series matrix sizes available, each in an HVA (RGBHV video and audio) and HV (RGBHV video only) model:

- CrossPoint Ultra 84 (8 inputs by 4 outputs)
- CrossPoint Ultra 88 (8 inputs by 8 outputs)
- CrossPoint Ultra 128 (12 inputs by 8 outputs)
- CrossPoint Ultra 168 (16 inputs by 8 outputs)
- CrossPoint Ultra 1212 (12 inputs by 12 outputs)
- CrossPoint Ultra 1616 (16 inputs by 16 outputs)

The CrossPoint Ultra Series switchers have a minimum bandwidth of 525 MHz (-3 dB). All models can also switch RGBS, RGsB, RsGsBs, HDTV, component video, S-video, and composite video.

## CrossPoint 450 Plus Switchers

There are four CrossPoint 450 Plus series matrix sizes available, each in an HVA (RGBHV video and audio) and HV (RGBHV video only) model:

- CrossPoint 450 Plus 2412 (24 inputs by 12 outputs)
- CrossPoint 450 Plus 2424 (24 inputs by 24 outputs)
- CrossPoint 450 Plus 3216 (32 inputs by 16 outputs)
- CrossPoint 450 Plus 3232 (32 inputs by 32 outputs)

The CrossPoint 450 Plus Series switchers have a minimum bandwidth of 450 MHz (-3 dB). All models can also switch RGSB, RGsB, RsGsBs, HDTV, component video, S-video, and composite video.

## MAV Plus Switchers

There are 13 different MAV Plus matrix sizes available, in a combination of matrix sizes and low resolution video formats, with or without audio or with audio only. The various matrix sizes and video formats are as follows:

- MAV Plus 88 (8 inputs by 8 outputs)
  - HDA (component/HDTV video and audio)
  - HD (component/HDTV video only)
  - SVA (S-video and audio)
  - SV (S-video only)
  - AV (composite video and audio)
  - V (composite video only)
  - A (audio only)
- MAV Plus 128 (12 inputs by 8 outputs)
  - HDA
  - HD
  - SVA
  - SV
  - AV
  - V
  - A
- MAV Plus 128 AV RCA (12 inputs by 8 outputs)
  - AV (with RCA audio connectors)
- MAV Plus 816 (8 inputs by 16 outputs)
  - HDA
  - HD
  - SVA
  - SV
  - AV
  - V
  - A
- MAV Plus 164 (16 inputs by 4 outputs)
  - A
- MAV 168 Plus (16 inputs by 8 outputs)
  - SVA
  - SV
  - AV
  - V
  - A
- MAV 1212 Plus (12 inputs by 12 outputs)
  - SVA
  - SV
  - AV
  - V

- MAV 1616 Plus (16 inputs by 16 outputs)
  - HDA                      • HD
  - SVA                      • SV
  - AV                        • V                      • A
- MAV 248 Plus (24 inputs by 8 outputs)
  - A
- MAV 2412 Plus (24 inputs by 12 outputs)
  - SVA                      • SV
  - AV                        • V                      • A
- MAV 2424 Plus (24 inputs by 24 outputs)
  - SVA                      • SV
  - AV                        • V                      • A
- MAV 328 Plus (32 inputs by 8 outputs)
  - A
- MAV 3216 Plus (32 inputs by 16 outputs)
  - SVA                      • SV
  - AV                        • V                      • A
- MAV 3232 Plus (32 inputs by 32 outputs)
  - SVA                      • SV
  - AV                        • V                      • A

MAV Plus HDA and HD switchers can also route low resolution RGsB and RsGsBs video signals. HDA and HD switchers can also route multiple composite video planes or S-video and composite video. If used in this way, the various video planes cannot be broken away; the input signals on the Y, R-Y, and B-Y input BNCs must be routed to the same outputs.

MAV Plus SVA and SV switchers can also be used to switch two planes of composite video. If used in this way, the two video planes cannot be broken away; the input signals on the luma and chroma input BNCs must be routed to the same outputs.

The MAV Plus Series switchers have a bandwidth of 150 MHz (-3 dB).

## Definitions

The following terms, which apply to Extron matrix switchers, are used throughout this guide:

**Tie** — An input-to-output connection.

**Set of ties** — An input tied to two or more outputs. (An output can never be tied to more than one input.)

**Configuration** — One or more ties or one or more sets of ties.

**Current configuration** — The configuration that is currently active in the switcher (also called configuration 0)

**Global memory preset** — A configuration that has been stored. Up to 32 global memory presets can be stored in memory. Preset locations are assigned to the input buttons and (where necessary) output buttons. Up to 20 or 32 (depending on the number of input and output buttons) presets can be selected from the front panel for either saving or retrieving. When a preset is retrieved from memory, it becomes the current configuration. All models have 32 presets; on models with fewer than 32 input and output buttons, preset numbers that are too high to be available from the front panel are still accessible under serial port or Ethernet control.

**Room** — A subset of outputs that are logically related to each other, as determined by the operator. The switchers support up to 10 rooms, each of which can consist of anywhere from 1 to 16 outputs.

**Room memory preset** — A configuration consisting of outputs in a single room that has been stored. When a room preset is retrieved from memory, it becomes the current configuration. The switchers support up to 10 presets per room.

## Features

**Video** — All switchers input and output video on BNC connectors.

**CrossPoint** — Both switcher models input and output ultra-wideband RGBHV or RGBS video. They can also switch RGsB, RsGsBs, component/HDTV, S-video, or composite video.

**MAV Plus** — These switchers input and output NTSC 3.58, NTSC 4.43, PAL, or SECAM video or HDTV video inputs. Depending on the video format of the switcher, these switchers can distribute low resolution RGsB, RsGsGs, component/HDTV, S-video, or composite video.

**Bandwidth** —

**CrossPoint** — Both CrossPoint switcher models provide a minimum of 425 MHz (-3 dB) video bandwidth, fully loaded.

**MAV Plus** — The MAV Plus switchers provide a minimum of 150 MHz (-3 dB) video bandwidth, fully loaded.

**Audio inputs (audio models)** —

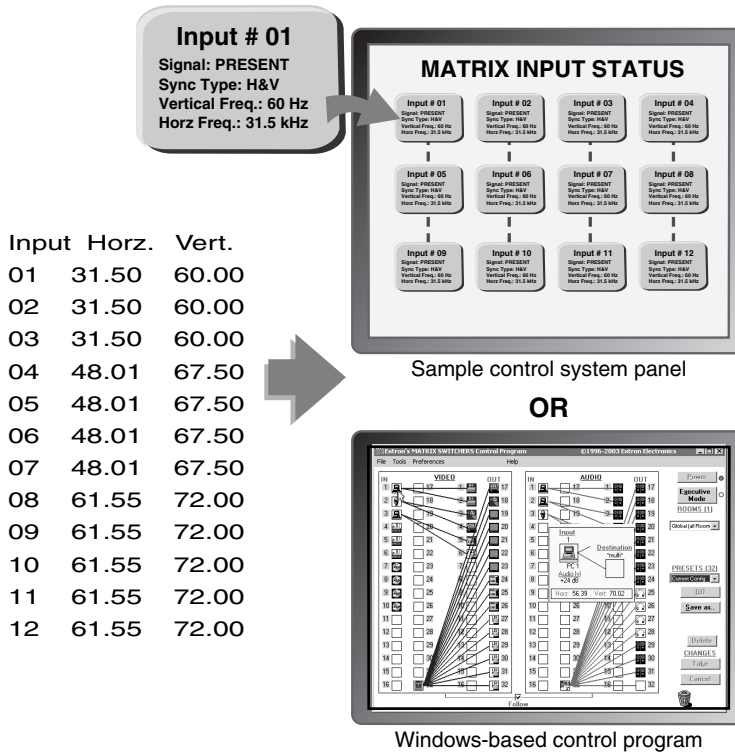
**All audio models, with the exception of the MAV Plus 128 AV RCA** — Input and output stereo audio, balanced or unbalanced, on 3.5 mm, 5-pole captive screw terminals.

**MAV Plus 128 AV RCA** — Input and output unbalanced stereo audio on left and right RCA connectors.

**Audio input gain/attenuation (audio models)** — Individual input audio levels can be adjusted so there are no noticeable volume differences between sources. Users can set the input level of audio gain or attenuation (-18 dB to +24 dB) via the Ethernet link, either serial port link, or the front panel.

**Audio output volume (audio models)** — The audio volume of each output can be displayed and adjusted through a range of full output to completely silent from the front panel or under serial port or Ethernet control.

**Digital Sync Validation Processing (DSVP) (CrossPoint)** — In critical environments or unmanned, remote locations, it may be vital to know that sources are active and switching. The Extron DSVP confirms that input sources are active by scanning all sync inputs for active signals. DSVP provides instantaneous frequency feedback for composite sync or separate horizontal and vertical sync signals via the serial ports or Ethernet port. The frequency information can be displayed on any control system or in a Windows®-based control program on a local-area network (LAN) or Internet (IP) connection (see figure 3).



**Figure 3. DSVP Data Display**

**RGB Delay (CrossPoint)** — A CrossPoint switcher can briefly blank the RGB (video) output while it switches to the sync source of the new input, and then switches the RGB signals. This allows a brief delay for the display to adjust to the sync timing of the selected input before displaying the new picture, which will appear without glitches. RGB delay, also known as Triple-Action Switching or video mute switching, is user selectable from 0 to 5 seconds, in half-second increments.

**Rooming** — Each switcher can be programmed to group multiple outputs to specific “rooms,” allowing them to have their own presets.

**Switching flexibility** — Provides individually buffered, independent matrix switched outputs with audio follow and audio breakaway for audio models.

- **Tie any input to any or all outputs**
- **Quick multiple tie** — Multiple inputs can be switched to multiple outputs simultaneously. This allows all displays (outputs) to change from source to source at the same time.
- **Audio follow** — Audio can be switched with its corresponding video input via front panel control or under Ethernet or serial port remote control.
- **Audio breakaway** — Audio can be broken away from its corresponding video signal. This feature allows any audio signal to be selected with any video signal simultaneously to one or all outputs in any combination. Audio breakaway switching can be done via front panel control or under Ethernet or serial port remote control.

**Operational flexibility** — Operations such as input/output selection, setting of presets, and adjustment of audio levels can be performed on the front panel or via the Ethernet or serial link. The serial links allow remote control via a PC or control system. The Ethernet link allows multiple remote links with two levels of password protection.

- **Front Panel Controller** — The front panel controller supports input and output selection, I/O grouping, preset creation and selection, RGB delay, and audio gain and attenuation and volume control (audio models). The front panel features illuminated pushbuttons that can be labeled with text or graphics.
- **Windows-based control program** — For serial port or Ethernet remote control from a PC, the Extron Windows-based control software provides a graphical interface and drag-and-drop/point-and-click operation. The Windows-based control program also has an emulation mode that lets you create a switcher configuration file at the home office and then download it for use by the switcher on site.
- **Simple Instruction Set (SIS)** — The remote control protocol uses Extron SIS for easy programming and operation.
- **Remote control panels and keypads** — The matrix switchers are remote controllable, using the optional MKP 2000 and MKP 3000 remote control keypads. The remote control devices are easy to use and provide tactile buttons for quick selection. Each MKP can be used for input-to-output switching, one-touch switching for a particular output. The MKP 3000 also can be used for selection of global presets.

**Upgradeable firmware** — The firmware that controls all switcher operation can be upgraded in the field via either serial port or the Ethernet port, without taking the switcher out of service. Firmware upgrades are available for download on the Extron Web site, [www.extron.com](http://www.extron.com) and they can be installed using the Windows-based control program or built-in HTML pages.

**Labeling** — The Extron button label software lets you create labels to place in the front panel I/O buttons, with names, alphanumeric characters, or color bitmaps for easy and intuitive input and output selection. Alternatively, labels can be made with any Brother™ P-Touch™ or comparable labeler.

**Global memory presets** — 20 or 32 (depending on the model) global memory presets are available on the front panel as a time-saving feature that lets you set up and store input/output configurations in advance. You can then recall those configurations, when needed, with a few simple steps. All 32 presets are available via serial port or Ethernet control.

**Rack mounting** — Rack mountable in any conventional 19 inch wide rack.



**Three front panel security lockout modes (*Executive modes*)** — If a matrix switcher is installed in an open area, where operation by unauthorized personnel may be a problem, either of two security lockout modes can be implemented (the third mode is unlocked). When a front panel locked mode is enabled, a special button combination or SIS command is required to unlock the front panel controller and make the front panel fully operational.

**I/O grouping** — Allows the matrix to be virtually divided into smaller sub-switchers, making installation and control easier. I/O grouping limits the selection of inputs and outputs to members of the same group. I/O grouping allows specific outputs, such as those designated for a specific purpose, to be grouped together.

**Power** — The matrix switchers' 100 VAC to 240 VAC, internal power supply(s) provides worldwide power compatibility.

**Primary and redundant power supplies (Matrix sizes 2412 and larger only)**— Includes two internal 100 VAC to 240 VAC, 50/60 Hz, switching power supplies, which provide worldwide power compatibility.

The power supply circuitry is configured to automatically switch over from the primary supply to the hot redundant supply in the case of a failure.

The hot redundant power supply means high reliability for the system and no loss of functionality should the primary supply fail; the redundant power supply immediately assumes the load.

**Power supply status LEDs (Matrix sizes 2412 and larger only)**— Front panel LEDs indicate the status of the primary and redundant power supplies.

# Installation

This sections details the installation and configuration of the CrossPoint Matrix Switchers and MAV Plus Matrix Switchers, including:

- [Setup and Installation Checklist](#)
- [Rear Panel Views](#)
- [Rear Panel Connections](#)
- [Front Panel Configuration Port](#)

## Setup and Installation Checklist

### Get ready

- Familiarize yourself with the matrix switcher.
- Obtain IP setting information for the matrix switcher from the local network administrator (see [Ethernet Connection](#) on page 149).

### Installation the switcher and make all connections

- If desired, install the switcher in a rack ([page 156](#)).
- Cable input and output video devices ([page 19](#)).
- Cable input and output audio devices ([page 24](#)).
- If desired, connect computers or control systems to any of the remote control ports (rear panel serial port [[page 26](#)], LAN port [[page 27](#)]), and front panel serial port ([page 30](#)), on the switcher.
- Connect power ([page 29](#)).
- Test the switcher by creating a tie ([page 43](#)).
- If desired, create and replace button labels (see [Removing and Installing Button Labels](#) on page 158).

### Ancillary operations

- Install the Matrix Switchers Control Program (see the [Matrix Software](#) beginning on page 110).

## Rear Panel Views

All connectors for all switchers are on the rear panel. Figure 4 through figure 14, on the following pages, show a representative sampling of all of the matrix switchers described in this guide. See [Rear Panel Connections](#), on page 19, for connecting cables to the rear panel connectors.

### ATTENTION:

- Use electrostatic discharge (ESD) precautions (be electrically grounded) when making connections. Electrostatic discharge can damage equipment, even if you cannot feel, see, or hear it.
- Prenez des précautions contre les décharges électrostatiques (soyez électriquement relié à la terre) lorsque vous effectuez des connexions. Les décharges électrostatiques (ESD) peuvent endommager l'équipement, même si vous ne pouvez pas le sentir, le voir ou l'entendre.
- Remove system power before making all connections.
- Débranchez l'alimentation du système avant de faire n'importe quelle connexion.

### Rear panel components

- ➊ **Video Input BNC connectors** — See [page 19](#) (CrossPoint) or [page 21](#) (MAV).
- ➋ **Video Output BNC connectors** — See [page 20](#) (CrossPoint) or [page 21](#) (MAV).
- ➌ **Sync termination switches (CrossPoint)** — See [page 23](#).
- ➍ **Audio Input captive screw connections** — See [page 24](#).
- ➎ **Audio Output captive screw connections** — See [page 24](#).
- ➏ **Audio Input RCA connections** — See [page 25](#).
- ➐ **Audio Output RCA connections** — See [page 25](#).
- ➑ **RS-232/422 DB-9 connector** — See [page 26](#).
- ➒ **Ethernet (LAN) RJ-45 port** — See [page 27](#).
- ➓ **Reset button** — See [page 28](#).
- ➔ **Ext(ernal) Sync BNC connector** — See [page 28](#).
- ➕ **Power IEC connector** — See [page 29](#).

## CrossPoint 450 Plus Switchers

**NOTE:** See **Rear panel components** on the previous page for a description of the callouts in figure 4.

Figure 4 shows the CrossPoint 450 Plus 3232 HVA RGB video and stereo audio matrix switcher.

**NOTE:** The CrossPoint 450 Plus 2412, 2424, and 3216 are housed in the same 10U or similar 8U enclosure, but have fewer output connectors to accommodate their smaller matrix sizes.

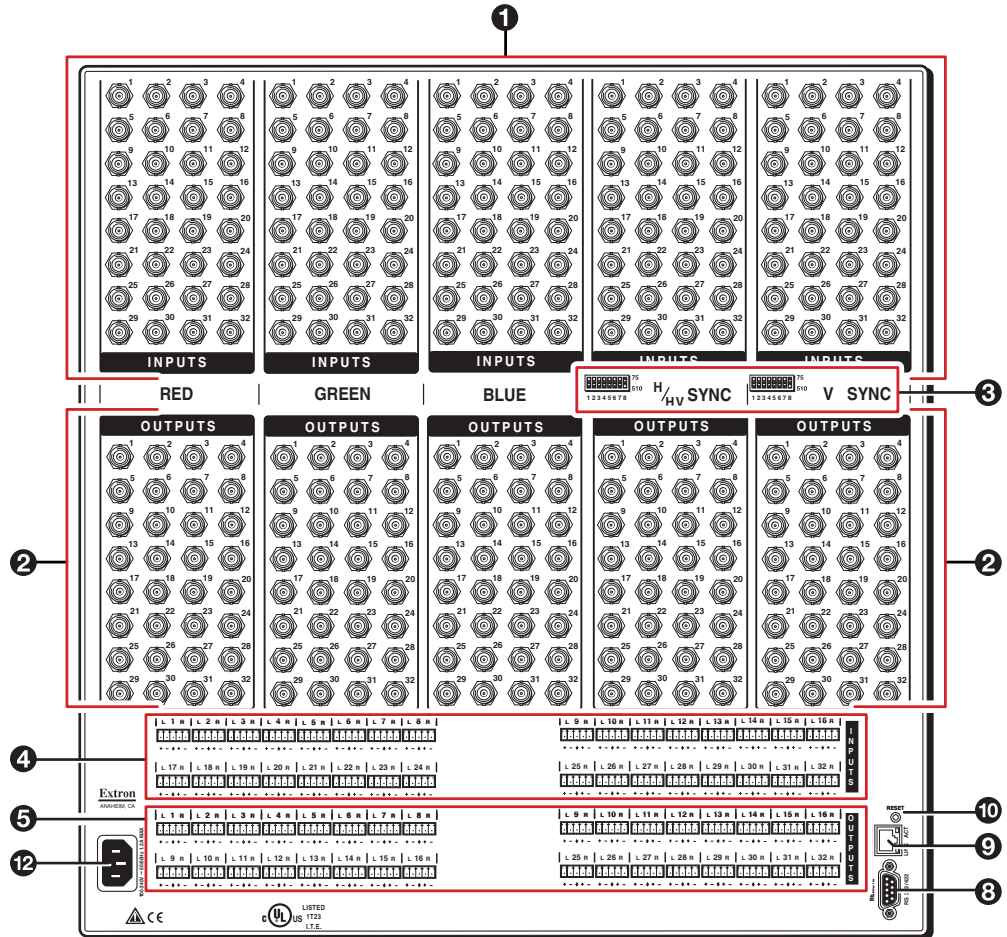


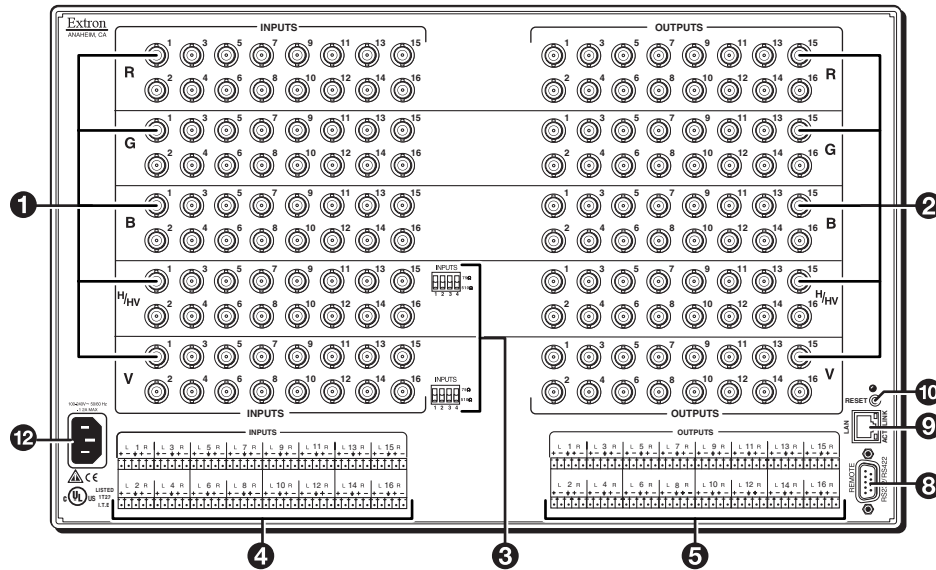
Figure 4. CrossPoint 450 Plus 3232 HVA Matrix Switcher

## CrossPoint Ultra Switchers

**NOTE:** See **Rear panel components** on page 13 for a description of the callouts in figures 5 and 6.

Figure 5 shows the CrossPoint Ultra 1616 HVA RGB video and stereo audio matrix switcher.

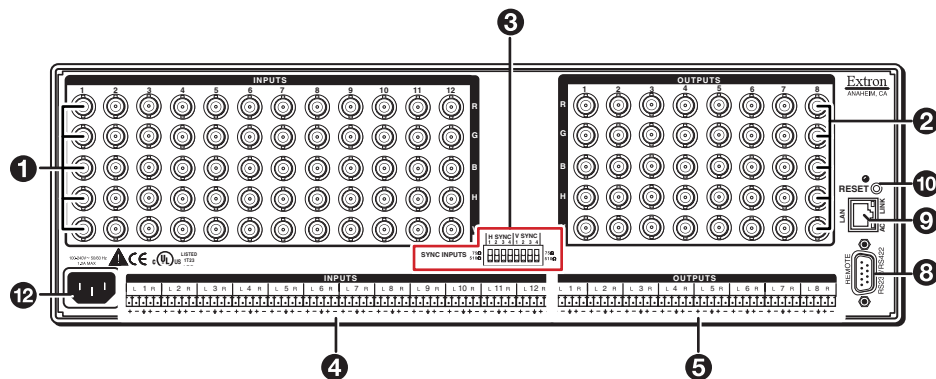
**NOTE:** The CrossPoint Ultra 168 is housed in the same 6U enclosure, but has fewer input connectors to accommodate its smaller matrix size.



**Figure 5.** CrossPoint Ultra 1616 HVA Matrix Switcher

Figure 6 shows the CrossPoint Ultra 128 HVA RGB video and stereo audio matrix switcher.

**NOTE:** The CrossPoint Ultra 84 and 88 are housed in the same 3U enclosure, but have fewer output connectors to accommodate their smaller matrix sizes.



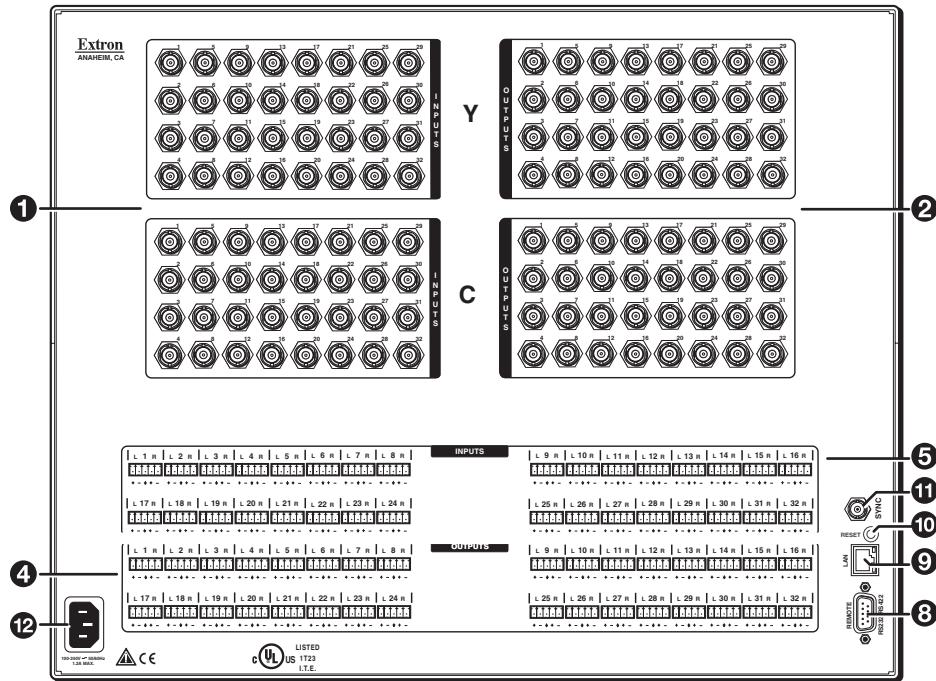
**Figure 6.** CrossPoint Ultra 128 HVA Matrix Switcher

## MAV Plus Switchers

**NOTE:** See **Rear panel components** on page 13 for a description of the callouts in figures 7 and 8.

Figure 7 shows the MAV Plus 3232 SVA S-video and stereo audio switcher.

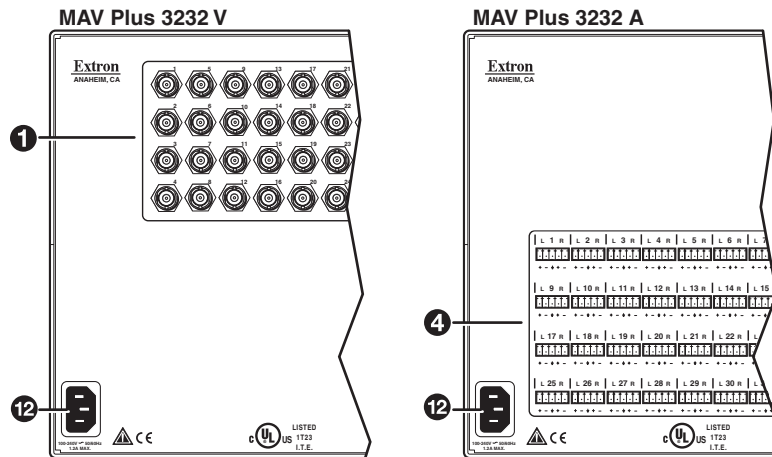
**NOTE:** The MAV Plus 2412, 2424, and 3216 are housed in the same 8U enclosure, but have fewer input or output connectors to accommodate their smaller matrix sizes.



**Figure 7. MAV Plus 3232 SVA Matrix Switcher**

Figure 8 shows a portion of the MAV Plus 3232 V composite video matrix switcher without audio and a portion of the MAV Plus 3232 A audio-only matrix switcher.

**NOTE:** Both of these switchers feature the same matrix size as figure 7, but in a 5U enclosure and with or without composite video format and audio.

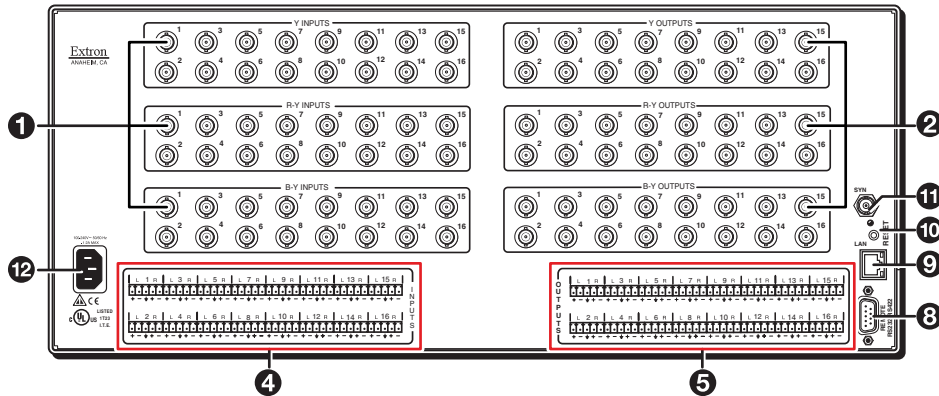


**Figure 8. MAV Plus 3232 Matrix Switchers with Various Formats**

**NOTE:** See **Rear panel components** on page 13 for a description of the callouts in figures 9 and 10.

Figure 9 shows a MAV Plus 1616 HDA component/HDTV video and stereo audio switcher.

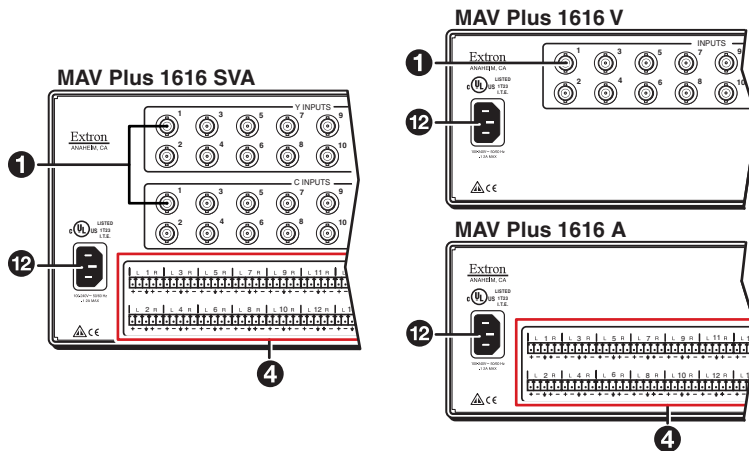
**NOTE:** The rear panel of the MAV Plus 816 and 168 models have the same features as the MAV Plus 1616 series models (see figure 9 and figure 10), but have fewer input or output connectors to accommodate their smaller matrix sizes.



**Figure 9. MAV Plus 1616 HDA Matrix Switcher**

Figure 10 shows a portion of the MAV Plus 1616 SVA S-video and stereo audio matrix switcher, a portion of the MAV Plus 1616 V composite video matrix switcher without audio, and a portion of the MAV Plus 1616 A audio-only matrix switcher.

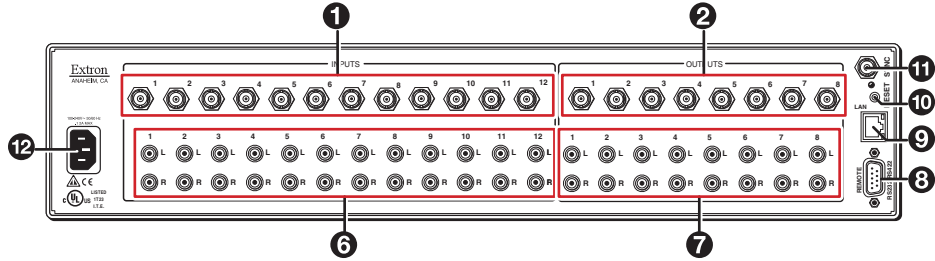
**NOTE:** All of these switchers feature the same matrix size as figure 9, but with different video formats and with or without video or audio.



**Figure 10. MAV Plus 1616 Matrix Switchers with Various Formats**

**NOTE:** See **Rear panel components** on page 13 for a description of the callouts in figures 11, 12, and 13.

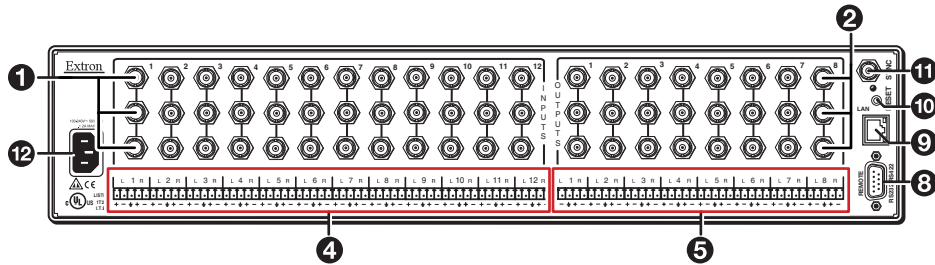
Figure 11 shows a MAV Plus 128 AV RCA composite video and stereo audio (with inputs and outputs on RCA connectors) matrix switcher.



**Figure 11. MAV Plus 128 AV RCA Matrix Switcher**

Figure 12 shows a MAV Plus 128 HDA component/HDTV video and stereo audio matrix switcher.

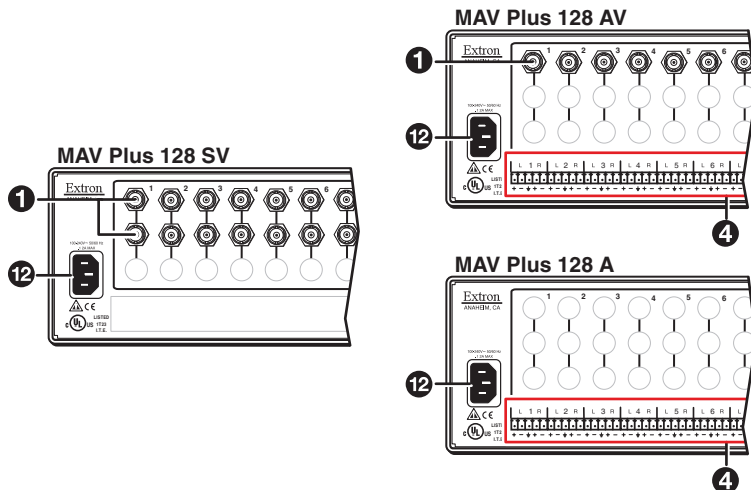
**NOTE:** The MAV Plus 88 models are housed in the same 2U enclosure, but have fewer input or output connectors to accommodate their smaller matrix sizes.



**Figure 12. MAV Plus 128 HDA Matrix Switcher**

Figure 13 shows a portion of the MAV Plus 128 SV S-video matrix switcher without audio, a portion of the MAV Plus 128 AV composite video and stereo audio matrix switcher, and a portion of the MAV Plus 128 A audio-only matrix switcher.

**NOTE:** All of these switchers feature the same matrix size as figure 12, but with different video formats and with or without audio.



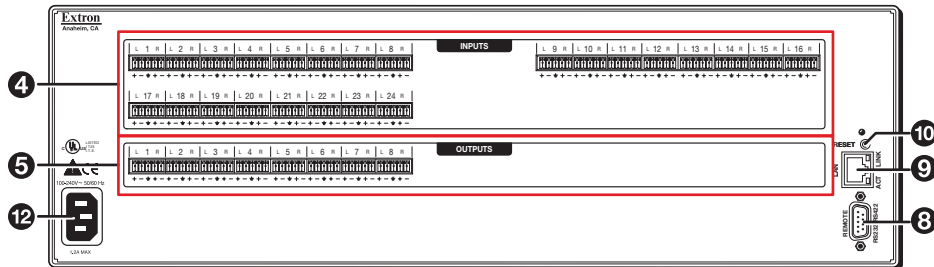
**Figure 13. MAV Plus 128 Matrix Switchers with Various Formats**



**NOTE:** See **Rear panel components** on page 13 for a description of the callouts in figures 14.

Figure 14 shows a MAV Plus 248 A audio matrix switcher (audio only).

**NOTE:** The MAV Plus 328 is housed in the same 3U enclosure, but has more input connectors to accommodate its larger matrix size.



**Figure 14. MAV Plus 248 A Matrix Switcher**

## Rear Panel Connections

### ATTENTION:

- Use electrostatic discharge (ESD) precautions (be electrically grounded) when making connections. Electrostatic discharge can damage equipment, even if you cannot feel, see, or hear it.
- Prenez des précautions contre les décharges électrostatiques (soyez électriquement relié à la terre) lorsque vous effectuez des connexions. Les décharges électrostatiques (ESD) peuvent endommager l'équipement, même si vous ne pouvez pas le sentir, le voir ou l'entendre.
- Remove system power before making all connections.
- Débranchez l'alimentation du système avant de faire n'importe quelle connexion.

## Video Input and Output (Video Models)

**NOTE:** The switchers do not alter the video signal in any way. The signal output by the switcher is in the same format as the input.

### RGBHV (CrossPoint switchers)

The switcher can connect to up to as many as 32 (CrossPoint 450 Plus) or 16 (CrossPoint Ultra) RGBHV video sources, depending on the model. The switcher can output to as many as 32 or 16 RGBHV video devices, depending on the model.

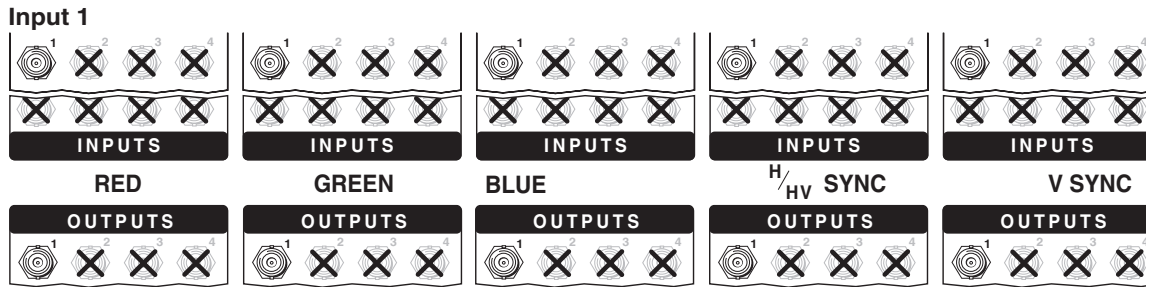
### NOTES:

- On all CrossPoint 450 Plus switchers and CrossPoint Ultra matrix sizes of 8 x 16 and larger, the connectors for each video plane are grouped together (all of the red inputs grouped together, all of the green inputs grouped, and so on). Ensure that you connect the input on each video plane to the corresponding connector in the correct group (see **figure 15**, on the next page).
- Both CrossPoint models can also switch RGBS, RGsB, RsGsBs, component video, S-video, or composite video by using four, three, two, or one BNC(s). If switching a video format other than RGBHV, ensure that the same video planes (R, G, B, H/HV, or V) are used on the switcher output as on the input.

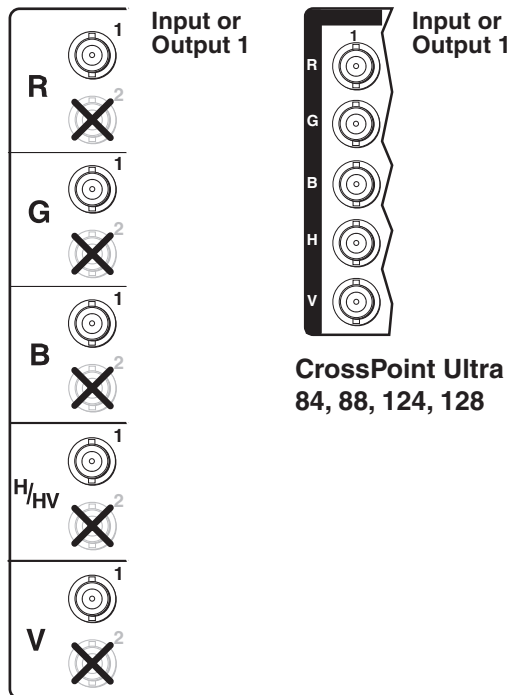
- 1 **Video inputs** — Connect RGB video, component/HDTV video, S-video, or composite video inputs, as applicable, to these BNC connectors for each input. **Figure 15**, on the next page, shows how to connect the RGB video format to each configuration.

- 2 **Video outputs** — Connect RGB video, component/HDTV video, S-video, or composite video displays, as applicable, or other devices to these BNC connectors for each output. **Figure 15**, below, shows how to connect the RGB video format to each configuration.

**CrossPoint 450 Plus**  
2412, 2424, 3216, 3232



**Output 1**



**CrossPoint Ultra**  
84, 88, 124, 128

**CrossPoint Ultra**  
816, 168, 1212, 1616

**Figure 15.** CrossPoint RGB Video Connections

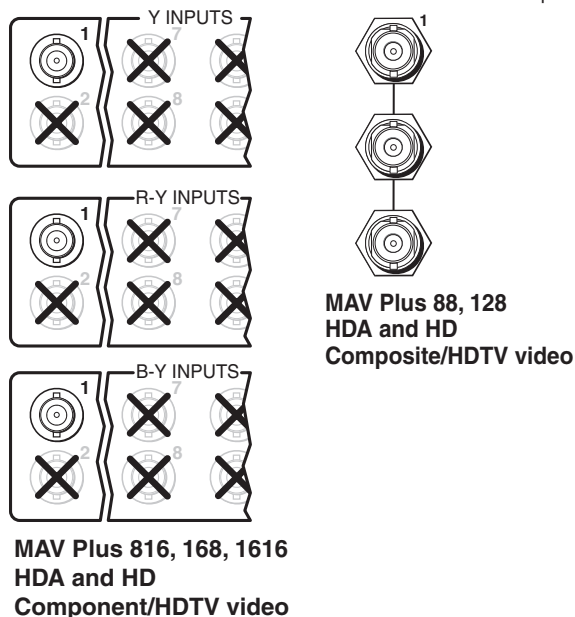
## Video (MAV Plus switchers)

### NOTES:

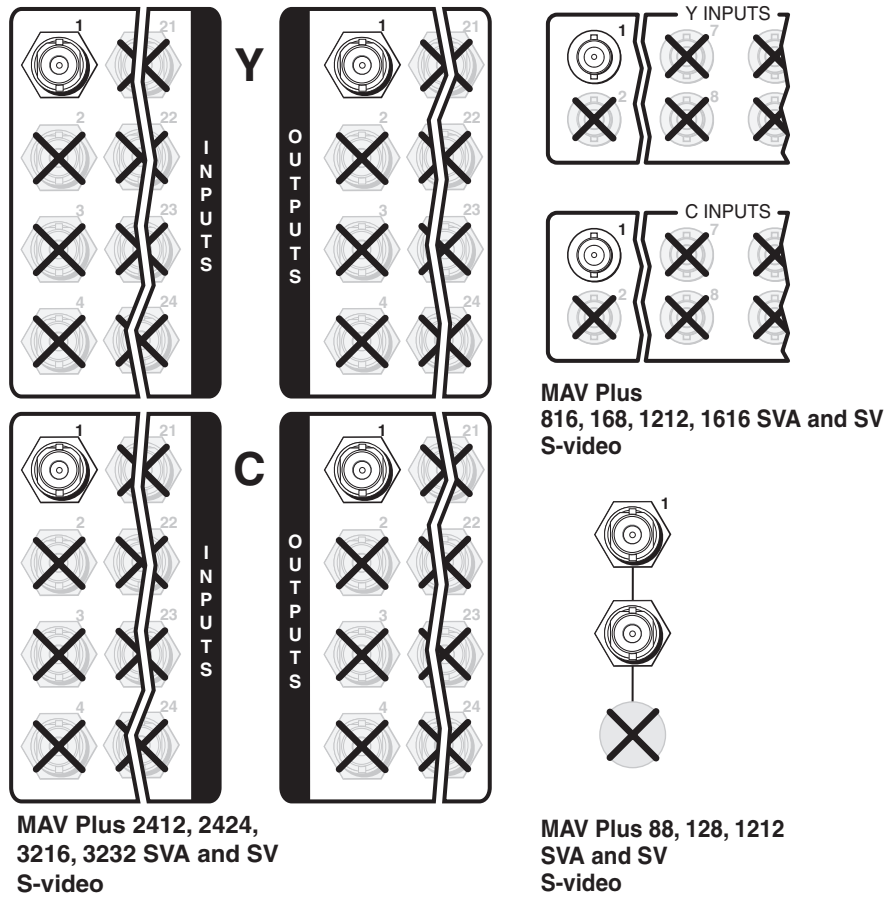
- Video input and output connections are made with female BNC connectors. Some video input and output devices do not have BNC video output connectors. For these cases, a suitable cable or connector adapter is necessary.
- The connectors for each video plane are grouped together (for example, for component/HDTV switchers, all of the Y inputs grouped together, all of the R-Y inputs grouped, and so on). Ensure that you connect the input on each video plane to the corresponding connector in the correct group (see figure 16, below and [figure 17](#) and [figure 18](#), both on the next page).

The switcher can connect to up to as many as 32 S-video or composite video or up to 16 component/HDTV video, S-video, or composite video sources, depending on the model. The switcher can output to as many as 32 S-video or composite video or up to 16 component video, S-video, or composite video devices, depending on the model.

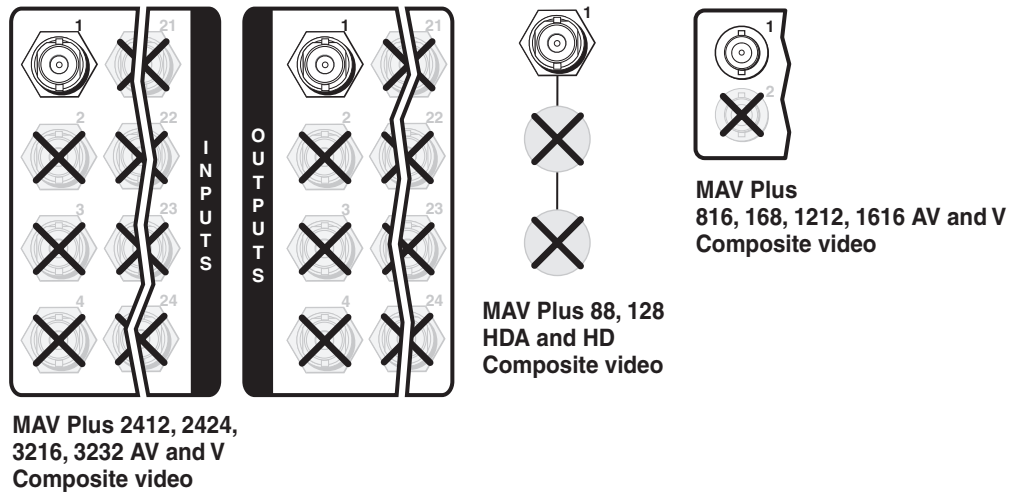
- 1 Video inputs** — Connect component/HDTV video (see [figure 16](#)), S-video (see [figure 17](#)), or composite video (see [figure 18](#)) inputs, as applicable, to these BNC connectors for each input.
- 2 Video outputs** — Connect component/HDTV video (see [figure 16](#)), S-video (see [figure 17](#)), or composite video (see [figure 18](#)) displays, as applicable, or other devices to these BNC connectors for each output.



**Figure 16. MAV Plus Component/HDTV Video Connections**



**Figure 17. MAV Plus S-video Connections**



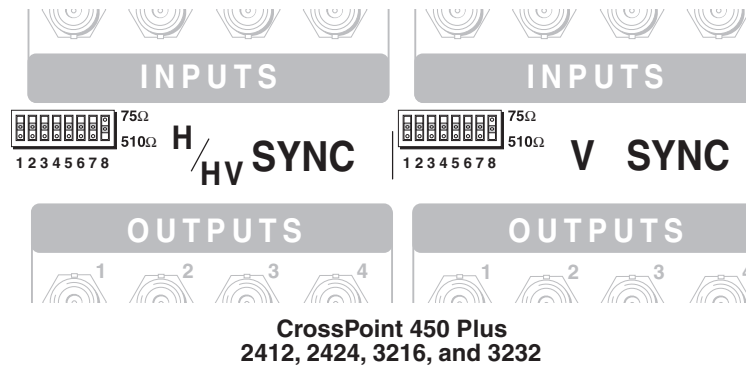
**Figure 18. MAV Plus Composite Video Connections**

## Sync Termination Switches (CrossPoint)

- ③ **Sync termination switches** — The RGB (CrossPoint) matrix switchers have input Sync termination switches on the rear panel (see figure 19) that provide a way to condition non-TTL sync levels greater than 5V p-p. Sync termination enables the sync to be properly passed from input to selected output(s). The matrix switchers have two sets of sync termination switches; one for horizontal or combined sync and a second set for vertical sync.

The **CrossPoint 450 Plus** matrix switchers have Sync termination switches for inputs 1 through 8.

The **CrossPoint Ultra** matrix switchers have Sync termination switches for inputs 1 through 4.



**CrossPoint Ultra**  
816, 168, 1212, and 1616

**Figure 19. Sync Termination Switches**

Each switch provides the option of selecting either 510 ohms or 75 ohms. The 75 ohms position is required only for an input with non-TTL sync, greater than 5V p-p. The normal position is 510 ohms.

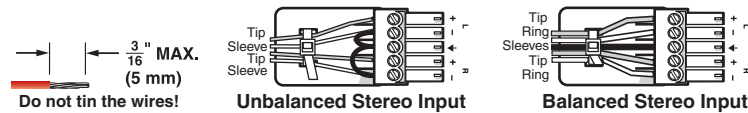
**NOTE:** An input that produces an out of sync display, a display that is rolling vertically with or without horizontal tearing, could indicate a non-TTL sync input. A device that is known to output non-TTL sync levels (greater than 5V p-p) should be connected to one of the inputs with sync termination switches, and the switches for that input should be set to the 75 ohm position. If you are not sure, check the specifications in the User Guide for the input device.

## Audio Input and Output (Audio Models)

By default, the audio ties follow the video ties. Audio breakaway ties select from any one of the audio input sources and route it separately from its corresponding video source (see [Example 3: Remove a tie from a set of ties](#) on page 45). You can also use an [SIS command](#) (see page 95), the Matrix Switchers Control Program (see [page 113](#)), or the HTML pages (see [Set and View Ties Page](#) on page 142).

### Captive Screw Connector Models (all Except MAV Plus 128 AV RCA)

**4 Connections for balanced and unbalanced audio inputs** — Each input has a 3.5 mm, 5-pole captive screw connector for balanced or unbalanced stereo audio input. Connectors are included with each switcher, but you must supply the audio cable. Figure 20 shows how to wire a connector for the appropriate input type. Use the supplied tie-wrap to strap the audio cable to the extended tail of the connector.



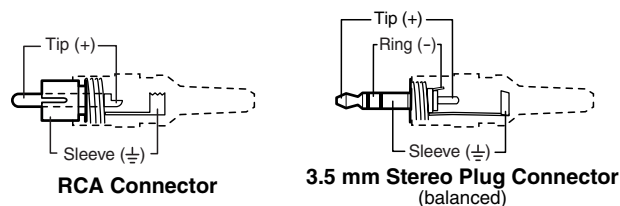
**Figure 20. Captive Screw Connector Wiring for Audio Inputs**

#### ATTENTION:

- The audio connector can easily be inadvertently plugged partially into one receptacle and partially into an adjacent receptacle. This misconnection could damage the audio output circuits. Ensure that the connector is plugged fully and only into the desired input or output.
- Le connecteur audio peut facilement être partiellement branché par inadvertance sur un réceptacle et partiellement sur un réceptacle adjacent. Cette mauvaise connexion est susceptible d'endommager les circuits de sortie audio. Vérifiez que le connecteur est correctement et uniquement branché sur l'entrée ou la sortie souhaitée.

#### NOTES:

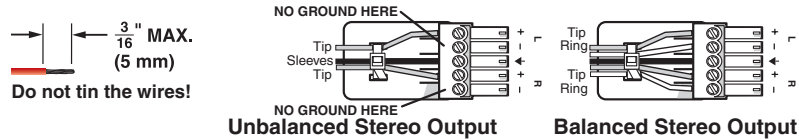
- The length of exposed wires is important. The ideal length is 3/16 inch (5 mm).
  - If the stripped section of wire is longer than 3/16 inch, the exposed wires may touch, causing a short circuit.
  - If the stripped section of wire is shorter than 3/16 inch, wires can be easily pulled out even if tightly fastened by the captive screws.
- Do not tin the power supply leads before installing them in the connector. Tinned wires are not as secure in the connector and could be pulled out.
- See figure 21 to identify the tip, ring, and sleeve when you are making connections for the switcher from existing audio cables. A mono audio connector consists of the tip and sleeve. A stereo audio connector consists of the tip, ring and sleeve. The ring, tip, and sleeve wires are also shown on the captive screw audio connector diagrams, figure 20 and figure 22.



**Figure 21. Typical Audio Connectors**

The audio level for each input can be individually set via the front panel or Ethernet or serial port control to ensure that the level on the output does not vary from input to input (see **Viewing and Adjusting the Input Audio Level** on page 63). You can also use an **SIS command** (see page 96), the Matrix Switchers Control Program (see **page 125**), or the HTML pages (see **Change the input gain and attenuation (audio models)** on page 144)

- ⑤ **Connections for balanced and unbalanced audio outputs** — These 3.5 mm, 5-pole captive screw connectors output the selected unamplified, line level audio. Connect audio devices, such as an audio amplifier or powered speakers. See figure 22 to properly wire an output connector. Use the supplied tie-wrap to strap the audio cable to the extended tail of the connector.



**Figure 22. Captive Screw Connector Wiring for Audio Output**

**ATTENTION:**

- For unbalanced audio, connect the sleeves to the ground contact. **DO NOT** connect the sleeves to the negative (-) contacts.
- Pour l'audio asymétrique, connectez les manchons au contact au sol. Ne PAS connecter les manchons aux contacts négatifs (-).

**NOTE:** The length of exposed wires is important. The ideal length is 3/16 inch (5 mm). See the **NOTES** on page 24 for details.

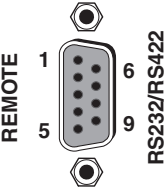
The volume level for each analog output can be individually set via the front panel or remote control (see the **Viewing and Adjusting the Analog Output Volume** on page 68). You can also use an **SIS command** (see page 97), the Matrix Switchers Control Program (see **page 125**), or the HTML pages (see **Change the output volume level (audio models)** on page 146).

**RCA connector model (MAV Plus 128 AV RCA)**

- ⑥ **Connections for unbalanced audio inputs** — Each input has a pair (left and right) of female RCA connectors for unbalanced stereo audio input.
- ⑦ **Connections for unbalanced audio outputs** — Each output has a pair (left and right) of female RCA connectors for unbalanced stereo audio output.

## RS-232/RS-422

- ⑧ **Remote RS-232/RS-422 connector** — Connect a host device, such as a computer, touch panel control, or RS-232 capable PDA to the switcher via this 9-pin D connector for serial RS-232/RS-422 control (see figure 23).



Pin	All Models		Matrix Sizes: 84 through 1616 MAV Plus 248 / 328 A		Matrix Sizes: 2412 through 3232	
	RS-232	Function	RS-422	Function	RS-422	Function
1	—	Not used	—	Not used	Tx+	Transmit data (+)
2	Tx	Transmit data	Tx-	Transmit data (-)	Tx-	Transmit data (-)
3	Rx	Receive data	Rx-	Receive data (-)	Rx+	Receive data (+)
4	—	Not used	—	Not used	Rx-	Receive data (-)
5	Gnd	Ground	Gnd	Ground	Gnd	Signal Ground
6	—	Not used	—	Not used	—	Not used
7	—	Not used	Rx+	Receive data (+)	—	Not used
8	—	Not used	Tx+	Transmit data (+)	—	Not used
9	—	Not used	—	Not used	—	Not used

**Figure 23. Remote RS-232/RS-422 Connector**

See **Programming Guide**, beginning on page 89, for definitions of the SIS commands (serial commands to control the switcher via this connector) and **Matrix Software**, beginning on page 110, for details on how to install and use the control software.

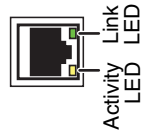
**NOTE:** The switcher can support either the RS-232 or RS-422 serial communication protocol, and operate at 9600, 19200, 38400, or 115200 baud rates. See **Selecting the rear panel RS-232/RS-422 port protocol and baud rate** on page 77, to configure the RS-232/RS-422 port from the front panel.

If desired, connect an MKP 2000 or MKP 3000 remote control panel to the RS-232/RS-422 connector on the switcher. See the *MKP 2000 Remote Control Panel User Guide* or the *MKP 3000 Remote Control Panel User Guide* for details.



## Ethernet

- 9 **Ethernet port** — If desired, for IP control of the system, connect the matrix switcher to a PC or to an Ethernet LAN, via this RJ-45 connector. You can use a PC to control the networked switcher with SIS commands from anywhere in the world. You can also control the switcher from a PC that is either running the Extron Windows-based control program or that has downloaded HTML pages from the switcher.



**Ethernet connection indicators** — The Link and Act LEDs indicate the status of the Ethernet connection. The Link LED indicates that the switcher is properly connected to an Ethernet LAN. This LED should light steadily. The Act LED indicates transmission of data packets on the RJ-45 connector. This LED should flicker as the switcher communicates.

It is vital that your Ethernet cables be the correct cable type and that they be properly terminated with the correct pinout. Ethernet links use unshielded twisted pair (UTP) or shielded twisted pair (STP) cables, terminated with RJ-45 connectors. Ethernet cables are limited to a length of 330 feet (100 m).

### NOTES:

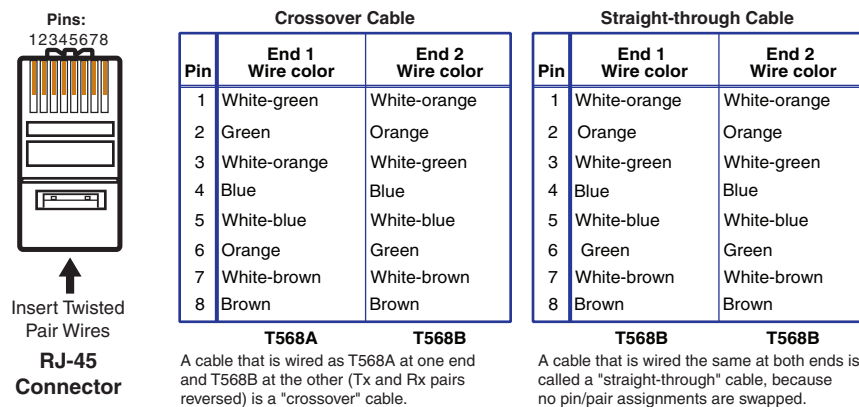
- Do not use standard telephone cables. Telephone cables do not support Ethernet or Fast Ethernet.
- Do not stretch or bend cables. Transmission errors can occur.

The cable used depends on your network speed. The switcher supports both 10 Mbps (10Base-T — Ethernet) and 100 Mbps (100Base-T — Fast Ethernet), half-duplex and full-duplex Ethernet connections.

- 10Base-T Ethernet requires CAT 3 UTP or STP cable at minimum.
- 100Base-T Fast Ethernet requires CAT 5e UTP or STP cable at minimum.

The Ethernet cable can be terminated as a straight-through cable or a crossover cable and must be properly terminated for your application (see figure 24).

- **Crossover cable** — Direct connection between the computer and the matrix switcher
- **Patch (straight) cable** — Connection of the matrix switcher to an Ethernet LAN.



**Figure 24. RJ-45 Connector and Pinout Tables**

## Reset Button

- 10 Reset button** — The Reset button initiates various levels of reset to the matrix switcher. Press and hold the button while the switcher is running or while you power up the switcher for different reset levels.

See **Rear Panel Reset Operations** on page 78, for details.



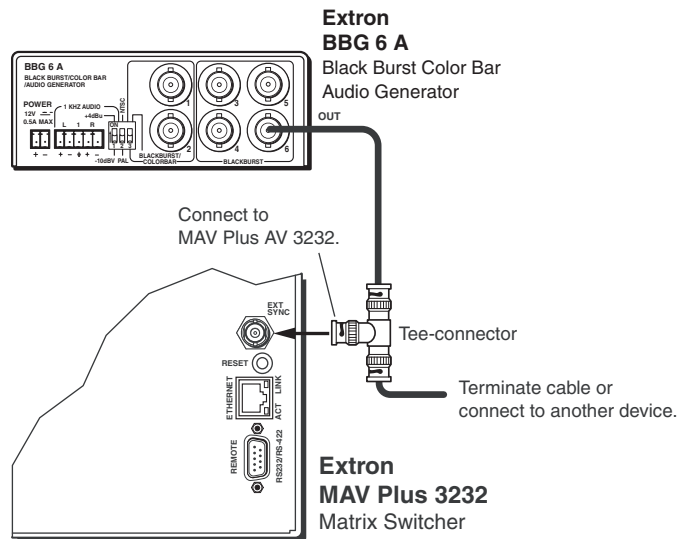
**NOTE:** The CrossPoint 450 Plus and MAV Plus 2412, 2424, 3216, and 3232 do not have the Reset LED shown in the figure at right.

## External Sync (MAV Plus Video Models)

The MAV Plus switcher switches between inputs during the vertical interval period, resulting in glitch-free video switching. The MAV switcher can use an external signal to synchronize switching during the vertical interval. Without the external sync locking feature, switching between inputs can result in a brief rolling (sync loss) or a brief change in the picture size.

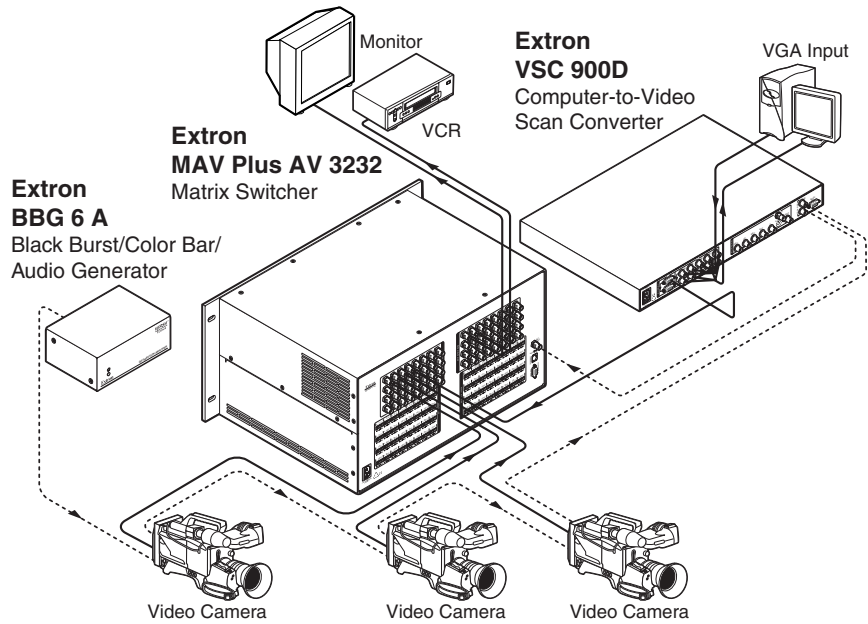
- 11 Ext(ernal) Sync connector** — Connect an external sync signal to this BNC connection for genlocking the video signal in broadcast or other sync-critical applications.

Figure 25 shows a basic external sync configuration. The Ext Sync connector receives the timing signal. A tee connector on the connector allows the signal to be passed on to another video device, if required. Terminate the tee connector if desired.



**Figure 25. Simple External Sync Connection Example**

Figure 26 shows another configuration, in which the timing source passes through three video cameras and a video scan converter before connecting to the switcher. This type of video camera is capable of synchronizing with the external timing source for video editing applications.



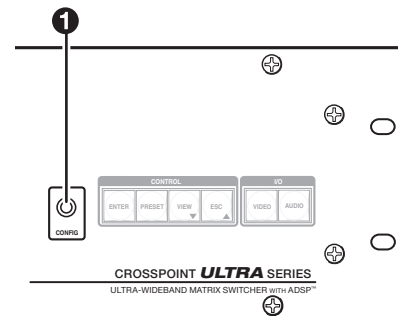
**Figure 26. Multiple Device External Sync Connection Example**

If no external sync timing source is connected to the switcher, switching occurs immediately.

## Power

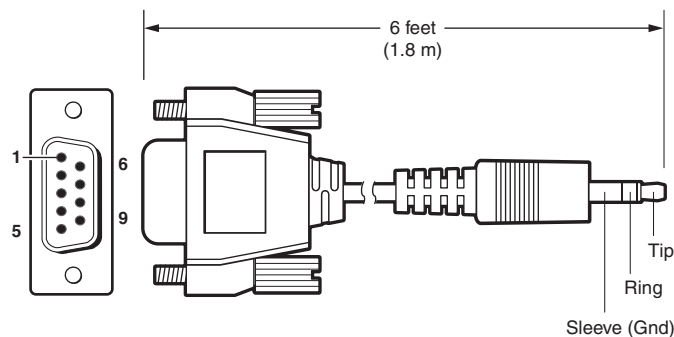
- ⑫ **AC power connector** — Plug a standard IEC power cord into this connector to connect the switcher to a 100 VAC to 240 VAC, 50 or 60 Hz power source.

## Front Panel Configuration Port (All Matrix Sizes up to 1616, and MAV Plus 248A and MAV Plus 328A Only)



**Figure 27. Front Panel Configuration Port**

- 1 Configuration port** — This 2.5 mm mini stereo jack serves the same communications function as the rear panel RS-232/RS-422 port, but it is easier to access than the rear port after the matrix switcher has been installed and cabled. The optional 9-pin D to 2.5 mm mini jack TRS RS-232 cable (see figure 28), can be used for this connection.



9-pin D	Connection	TRS Plug
Pin 2	Rx line on the computer	Tip
Pin 3	Tx line on the computer	Ring
Pin 5	Signal ground on the computer	Sleeve

**Figure 28. Optional 9-pin TRS RS-232 Cable**

### NOTES:

- This port is independent of the rear panel RS-232/RS-422 port and is *not* affected by changes to the protocol of the rear panel port. The protocol of this front panel port can be changed, under SIS command control only. See the Command and Response table for IP SIS commands, on page 107, to configure all ports under SIS control.
- A front panel Configuration port connection and a rear panel RS-232/RS-422 port connection can both be active at the same time.
- This port is RS-232 only, with its default protocols as follows:
  - 9600 baud
  - 1 stop bit
  - no parity
  - no flow control
  - 8 data bits
- The maximum distances from the matrix switcher to the controlling device can vary up to 200 feet (61 m). Factors such as cable gauge, baud rates, environment, and output levels (from the switcher and the controlling device) all affect transmission distance. Distances of about 50 feet (15 m) are typically not a problem. In some cases the matrix switcher may be capable of serial communications via RS-232 up to 250 feet (76 m) away.

# Operation

This section describes the front panel operation of the CrossPoint Matrix Switchers and MAV Plus Matrix Switchers, including:

- **Front Panel Controls and Indicators**
- **Front Panel Operations**
- **Rear Panel Operations**
- **Optimizing the Audio (Audio Models)**
- **Troubleshooting**
- **Configuration Worksheets**

**NOTE:** The operation and appearance of all CrossPoint 450 Plus, CrossPoint Ultra, and MAV Plus switchers are very similar. Exceptions:

- The video selection button is labeled “RGBHV” on the CrossPoint models and “Video” on the MAV Plus switchers.
- The MAV Plus switchers do not offer RGB delay switching.
- The MAV Plus 248 A and MAV Plus 328A are in smaller enclosures than other 24-input and 32-input matrix sizes. Unlike other switchers in small enclosures, they have front panel Primary and Redundant Power Supply indicators.

## Front Panel Controls and Indicators

The front panel controls (see figure 29 through figure 31) are in two sets. The input and output buttons are on the left side of the control panel. The control buttons and video/audio (I/O) selection buttons are on the right side of the panel.

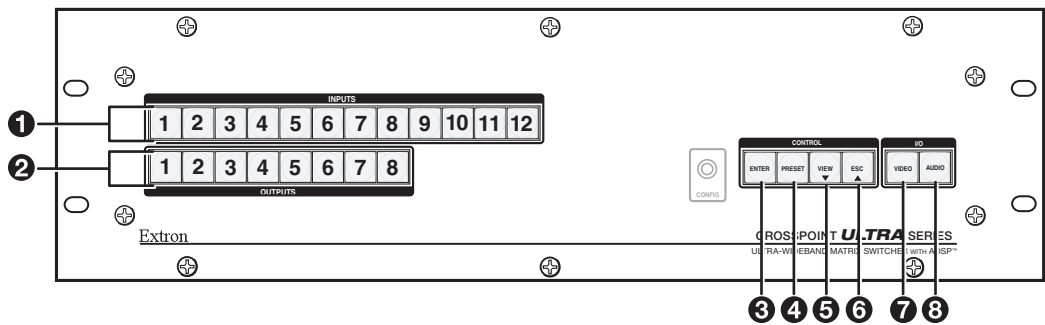
**NOTE:** While the number of inputs and outputs varies depending on the size and model of the matrix switcher, there are only three front panel arrangements: 12 input buttons by 8 output buttons (see figure 29), 16 by 16 (see figure 30), and 32 by 32 (see figure 31). See **table 1**, on the next page, to identify the front panel arrangements used by each switcher model.

On smaller matrix switchers, the larger-numbered buttons are not used for input and output selection, although they are used to select and indicate preset numbers, indicate the input audio level, and indicate the output audio volume.

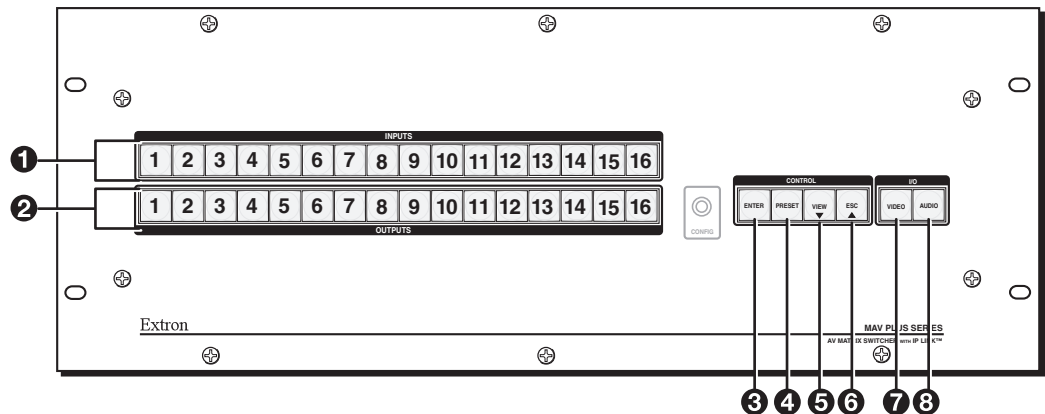
**Table 1. Comparison of Front Panels of Models**

Switcher model	Panel			Figure
	12 x 8	16 x 16	32 x 32	
CrossPoint Ultra 84, 88, 124, 128 MAV Plus 88, 128	●			29
CrossPoint Ultra MAV Plus 816, 1212, 1616		●		30
CrossPoint 450 Plus MAV Plus 248, 2412, 2424, 328, 3216, 3232			●	31

The pushbuttons can be labeled with text or graphics. The pushbuttons can be set to provide background illumination all the time or the background illumination can be turned off (see **Background illumination** on page 77). When selected, the pushbuttons blink or are lit at full intensity, depending on the operation.

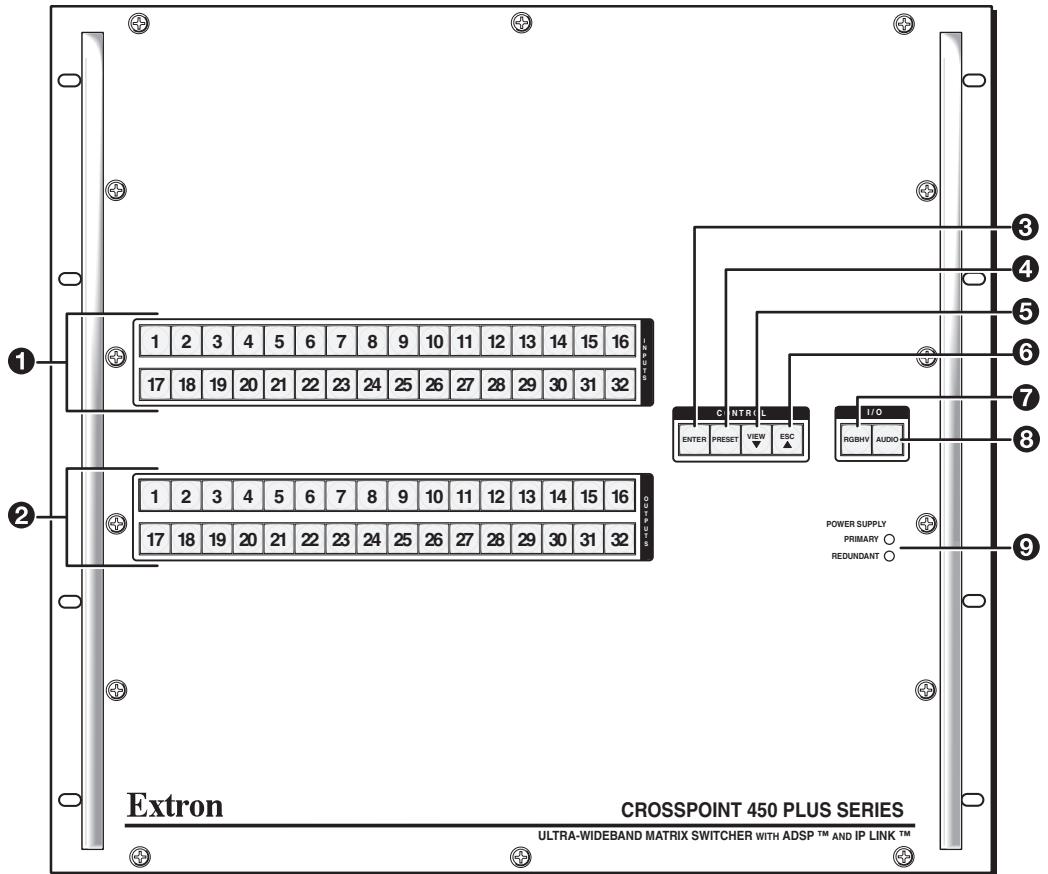


**Figure 29. Front panel, CrossPoint Ultra 128 HVA**



**Figure 30. Front Panel, MAV Plus 1616 HDA**

- 1** Input buttons — See [page 35](#).
- 2** Output buttons — See [page 35](#).
- 3** Enter button — See [page 36](#).
- 4** Preset button — See [page 37](#).
- 5** View button — See [page 37](#).
- 6** Esc button — See [page 37](#).
- 7** RGBHV or Video button — See [page 38](#).
- 8** Audio button — See [page 39](#).



**Figure 31.** Front Panel, CrossPoint 450 Plus 3232 Series

- |   |  |
|---|--|
| <ul style="list-style-type: none"> <li><b>❶</b> Input buttons — See <a href="#">page 35</a>.</li> <li><b>❷</b> Output buttons — See <a href="#">page 35</a>.</li> <li><b>❸</b> Enter button — See <a href="#">page 36</a>.</li> <li><b>❹</b> Preset button — See <a href="#">page 37</a>.</li> <li><b>❺</b> View button — See <a href="#">page 37</a>.</li> </ul> | <ul style="list-style-type: none"> <li><b>❻</b> Esc button — See <a href="#">page 37</a>.</li> <li><b>❼</b> RGBHV or Video button — See <a href="#">page 38</a>.</li> <li><b>❽</b> Audio button — See <a href="#">page 39</a>.</li> <li><b>❾</b> Power Supply LEDs — See <a href="#">page 39</a>.</li> </ul> |
|---|--|

## Input and Output Buttons

### NOTES

- Input and output buttons cannot select an input number or output number that is higher than your matrix size supports. Buttons numbered higher than your matrix size do have other functions as described in the following pages.
- See **Front Panel Operations**, beginning on page 40 for detailed descriptions of the following operations.





Primary functions		
Action	Select input or output for tie being created.	
Indication	<i>Blink</i> : potential tie/untie. <i>Lit</i> : current tie <i>Amber</i> : video and audio tie <i>Green</i> : video only tie <i>Red</i> : audio only tie	
	<div style="display: flex; justify-content: space-around; align-items: center;"> <div style="border: 1px solid black; padding: 5px; text-align: center; width: 40px; height: 40px; margin: 5px;">1</div> <div style="border: 1px solid black; padding: 5px; text-align: center; width: 40px; height: 40px; margin: 5px;">2</div> <div style="border: 1px solid black; padding: 5px; text-align: center; width: 40px; height: 40px; margin: 5px;">3</div> <div style="margin: 0 10px;">through up to</div> <div style="border: 1px solid black; padding: 5px; text-align: center; width: 40px; height: 40px; margin: 5px;">32</div> </div>	
Secondary functions		
<b>I/O Grouping</b>	Action 1:	<b>Input 1 and Output 1:</b> Select I/O Group mode.
	Action 2/ indication:	Assign an input or output to the selected group. <i>Lit</i> : Input or output is assigned to the selected group.
<b>Presets</b>	Action	Select a preset in <i>Preset</i> mode.
	Indication	<i>Lit</i> : A preset has already been saved to this location. <i>Blink</i> : Preset location is selected to be saved.
<b>RGB Delay</b>	Indication:	<b>CrossPoint:</b> <b>Input 1 through 10:</b> Indicate the RGB delay.
<b>Input audio level</b>	Action	<b>Input buttons:</b> Select the input for audio gain or attenuation adjustment.
	Indication	<b>Input buttons lit:</b> Input audio selected for adjustment.
	Indication	<b>Output buttons lit or blinking:</b> Indicate the input gain or attenuation level.
<b>Output audio volume</b>	Action	<b>Output buttons:</b> Select the output for audio volume adjustment.
	Indication	<b>Output buttons lit:</b> Output audio is selected for adjustment.
	Indication	<b>Input buttons lit or blinking:</b> Indicated the output volume level.
<b>Output mutes</b>	Action	<b>Output buttons:</b> Press and hold to mute or unmute the output.
	Indication	<b>Output buttons blinking:</b> Output is muted.
<b>Background illumination</b>	Action	<b>Input 1 and Input 2:</b> Toggle between background illumination or buttons unlit.



- ① **Input buttons** — The input buttons have one primary function (□) and six secondary functions (●):
- Select and identify an input for ties or for audio level adjustment (**audio models**).
  - **(Input 1)** With the Output 1 button, select *I/O Group* mode.
  - Assign an input to the selected group in *I/O Group* mode and indicate its assignment.
  - Select a preset.
  - **(CrossPoint switchers, Input 1 through 10)** Display the RGB delay.
  - **(Audio models)** Display the volume of the selected output.
  - **(Input 1 and Input 2)** Toggle background illumination of the buttons on and off.
- ② **Output buttons** — The output buttons have one primary function (□) and five secondary functions (●):
- Select and identify an output for ties or for volume adjustment.
  - **(Output 1)** With the Input 1 button, select *I/O Group* mode.
  - Assign an output to the selected group in *I/O Group* mode and indicate its assignment.
  - **(84, 88, 124, 128, 1212, and 1616 matrix sizes)** Select a preset.
  - Mute the output.
  - **(Audio models)** Display the audio level of the selected input.

## Control Buttons

**NOTE:** See **Front Panel Operations**, beginning on page 40 for detailed descriptions of the following operations.

Primary functions					
	Action	Save changes	Select <i>Preset</i> mode	Select <i>View</i> mode	Cancel or Escape
	Indication	<i>Blink</i> : Save needed	<i>Blink</i> : Save preset <i>Lit</i> : Recall preset	View mode selected	Flashes once
					
Secondary functions					
<b>I/O Grouping</b>	Action/ indication:	Select group 1	Select group 2	Select group 3	Select group 4
<b>Port configuration</b>	Action 1	Select <i>Configuration</i> mode.			
	Action 2	Select 9600 baud	Select 19200 baud	Select 38400 baud	Select 115200 baud
	Indication	<i>Blink</i> : 9600 baud	<i>Blink</i> : 19200 baud	<i>Blink</i> : 38400 baud	<i>Blink</i> : 115200 baud
<b>Front panel locks</b>	Action 1	With Video and Audio, select <i>Lock</i> mode 2 or toggle between mode 0 and mode 2.			
<b>RGB Delay</b>	Action:			<b>CrossPoint:</b> In <i>RGB Delay</i> mode, decrease the switching interval.	
<b>Audio</b>	Action			In <i>Audio</i> mode, decrease <b>input level</b> or <b>output volume</b> .	In <i>Audio</i> mode, increase <b>input level</b> or <b>output volume</b> .

③ **Enter button** — The Enter button has two primary functions (☐) and four secondary functions (•):

- ☐ Saves configuration or preset changes that you make on the front panel. To create a simple configuration:
  - Specify video, audio, or both (see I/O buttons [item 7] and [item 8]).
  - Press the desired input button (item 1).
  - Press the desired output button or buttons (item 2).
  - Press the Enter button.
- ☐ Indicates that a potential tie has been created but not saved.
  - In the *I/O Group* mode, select group 1 and indicate the selection.
  - With the Preset, View, and Esc buttons, selects *Serial Port Selection and Configuration* mode.
  - Selects 9600 baud for the rear panel Remote port in *Serial Port Selection and Configuration* mode and indicates the selection.
  - With the RGBHV or Video and Audio buttons, select front panel security *Lock* mode 2 or toggle between mode 0 (unlocked) and mode 2.

④ **Preset button** — The Preset button has two primary functions (□) and three secondary functions (●):

- Activates *Save Preset* mode to save a configuration as a preset and *Recall Preset* mode to activate a previously-defined preset.
- Blinks when *Save Preset* mode is active and lights steadily when *Recall Preset* mode is active.
- In the *I/O Group* mode, select group 2 and indicate the selection.
- With the Enter, View, and Esc buttons, selects *Serial Port Selection and Configuration* mode.
- Selects 19200 baud for the rear panel Remote port in *Serial Port Selection and Configuration* mode and indicates the selection.

⑤ **View (<) button** — The View (▼) button has one primary function (□) and six secondary functions (●):

- Select and indicate View-only mode, which displays the current configuration.

**NOTE:** View-only mode also provides a way to mute and unmute the outputs.




- In the *I/O Group* mode, select group 3 and indicate the selection.
- **(CrossPoint switchers)** Decrease the RGB delay of switches to the selected output.
- **(Audio models)** Decreases the audio level of the selected analog input.
- **(Audio models)** Decreases the volume of the selected analog output.
- With the Enter, Preset, and Esc buttons, selects *Serial Port Selection and Configuration* mode.
- Selects 38400 baud for the rear panel Remote port in *Serial Port Selection and Configuration* mode, and indicates the selection.

⑥ **Esc (>) button** — The Esc (▲) button has two primary functions (□) and six secondary functions (●):

- Cancels operations or selections in progress and resets the front panel button indicators.
- Flashes once to indicate that the escape function has been activated.
- In the *I/O Group* mode, select group 4 and indicate the selection.
- **(CrossPoint switchers)** Increase the RGB delay of switches to the selected output.
- **(Audio models)** Increases the audio level of the selected analog input.
- **(Audio models)** Increases the volume of the selected analog output.
- With the Enter, Preset, and View buttons, selects *Serial Port Selection and Configuration* mode.
- Selects 115200 baud for the rear panel Remote port in *Serial Port Selection and Configuration* mode and indicates the selection.

## I/O Controls

**NOTE:** See **Front Panel Operations**, beginning on page 40 for detailed descriptions of the following operations.

Primary functions			
	Action	Select video	Select audio
	Indication	Green: selected	Red: selected
		 or 	
Secondary functions			
<b>Front panel locks</b>	Action 1	With Enter, select <i>Lock</i> mode 2 or toggle between mode 0 and mode 2.	
	Action 2	Select <i>Lock</i> mode 1 or toggle between mode 2 and mode 1.	
<b>RGB Delay</b>	Action/ indication	Select <i>RGB Delay</i> mode. Blinks green.	
<b>Resets</b>	Action 1	Perform a system reset.	
<b>Port configuration</b>	Action	Select RS-232.	Select RS-422
	Indication	<i>Blink</i> : selected	<i>Blink</i> : selected
Audio	Action		Select <i>Audio</i> mode.

You must specify video, audio, or both when you are creating or viewing a configuration. This is done with the RGBHV button (CrossPoint switchers) or Video button (MAV Plus switchers) (7) and Audio (8) buttons.

- 7 RGBHV (CrossPoint) button or Video (MAV Plus) button** — The RGBHV (CrossPoint switchers) or Video (MAV Plus switchers) button has one primary function (□) and five secondary functions (•):
- Selects and deselects video for a configuration that is being created or viewed and lights green to indicate that video is available for configuring or for viewing.
  - With the Enter button and Audio button, selects between front panel locks (*Lock* mode 2 and *Lock* mode 0).
  - With the Audio button, commands the front panel system reset.
  - **(CrossPoint switchers)** Selects the *RGB delay* mode, in which you can set the RGB delay.
  - Selects the RS-232 protocol for the rear panel Remote port in *Serial Port Selection and Configuration* mode and indicates the selection.

- 8 Audio button** — The Audio button has one primary function (☐) and six secondary functions (●):
- ☐ Selects and deselects audio for a configuration that is being created or viewed and lights to indicate that audio is available for configuration or viewing.
  - **(Audio models)** Selects the *Audio* mode, in which you can adjust the analog input audio level and the analog output audio volume.
  - With the Enter button and RGBHV or Video button, selects between front panel locks (*Lock mode 2* and *Lock mode 0*).
  - With the RGBHV or Video button, selects between front panel locks (*Lock mode 2* and *Lock mode 1*).
  - With the RGBHV or Video button, commands the front panel system reset.
  - Selects the RS-422 protocol for the rear panel Remote port in *Serial Port Selection and Configuration* mode and indicates the selection.

## Power LEDs (2412 and Larger Models Only)

### 9 Primary and Redundant Power Supply LEDs —

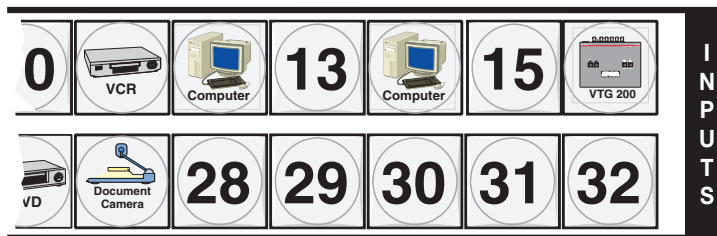
**Green** — Indicates that the associated power supply is operating within normal tolerances.

**Red** — Indicates that the associated power supply is operating outside the normal tolerances or has failed.

## Button Icons

The numbered translucent covers on the input and output pushbuttons can be removed and replaced to insert labels behind the covers.

Input and output labels can be created easily with the Extron Button-Label Generator software, which is available on the Extron web site ([www.extron.com](http://www.extron.com)). Each input and output can be labeled with names, alphanumeric characters, or color bitmaps for easy and intuitive input and output selection (see figure 32). See **Button-Label Generator Program**, on page 129, for details on using the labeling software. See **Removing and Installing Button Labels**, on page 158, for details on using the labeling software, blank labels you can fill in yourself, and a procedure for removing and replacing the translucent covers.



**Figure 32.** Sample Button Icons

## Front Panel Operations

The following sections detail the power-up process and then provide sample procedures for the following actions:

- **Creating ties, sets of ties, and configurations**
- **Changing a configuration**
- **Viewing ties, sets of ties, and configurations**
- **I/O grouping**
- **Setting the RGB delay**
- **Saving a preset**
- **Recalling a preset**
- **Muting and unmuting outputs**
- **Viewing and Adjusting the Input Audio Level**
- **Viewing and Adjusting the Output Volume**
- **Locking and unlocking the front panel**
- **Performing front panel resets**
- **Toggling background illumination on and off**
- **Reading and setting the Remote RS-232/RS-422 port settings**

## Definitions

The following Extron matrix switcher terms are used throughout this guide:

**Tie** — An input-to-output connection

**Set of ties** — An input tied to two or more outputs.

**NOTE:** An output can never be tied to more than one input.

**Configuration** — One or more ties or one or more sets of ties

**Current configuration** — The configuration that is currently active in the switcher (also called configuration 0)

**Global memory preset** — A configuration that has been stored. Up to 32 global memory presets can be stored in memory. Preset locations are assigned to the input buttons and (where necessary) output buttons. When a preset is retrieved from memory, it becomes the current configuration.

All models have 32 presets; on models with fewer than 32 input and output buttons, preset numbers that are too high to be available from the front panel are still accessible under serial port or Ethernet control.

**Room** — A subset of outputs that are logically related to each other, as determined by the operator. The switchers support up to 10 rooms, each of which can consist of anywhere from 1 to 16 outputs.

**Room memory preset** — A configuration consisting of outputs in a single room that has been stored. When a room preset is retrieved from memory, it becomes the current configuration.

## Power

Apply power by connecting the power cord between the switcher and an AC source. The switcher performs a self-test that flashes the front panel button indicators red, green, and amber and then turns them off. An error-free power-up self-test sequence leaves all input, output, and control buttons either unlit or showing background illumination. The lit or unlit status of the RGBHV or Video button and the Audio button is defined by the system configuration as follows:

- **Audio models** — RGBHV or Video and Audio both lit
- **Models without audio** — RGBHV or Video lit and Audio unlit

The current configuration and all presets are saved in non-volatile memory. When power is applied, the most recent configuration is retrieved. The previous presets remain intact.

If an error occurs during the self-test, the switcher locks up and does not operate. If your switcher locks up on power-up, call the Extron S3 Sales and Technical Support Hotline. See the **end** of this guide for the phone number in your region of the world.

## Front Panel Security Lockouts

In the procedural descriptions that follow, it is assumed that the switcher is in *Lock mode 0* (fully unlocked). The following two *Lock modes* are also available:

- **Lock mode 1** — All changes are locked from the front panel (except for setting *Lock mode 2*). Some functions can be viewed.
- **Lock mode 2** — Advanced features are locked and can be viewed only. Basic functions are unlocked.

**NOTE:** The switcher is shipped from the factory in *Lock mode 2*. See **Setting the Front Panel Locks (Executive Modes)** on page 75 for a detailed list of basic and advanced functions and the procedure to set the various front panel locks.

## Creating a Configuration

The current configuration can be changed using the front panel buttons. Change the current configuration as follows:

1. Press the Esc button to clear any input button indicators, output button indicators, or control button indicators that may be lit.
2. Select video, audio, or both for configuration by pressing the RGBHV (CrossPoint switchers) or Video (MAV Plus switchers) button and Audio button as necessary.
3. Select the desired input and one or more output by pressing the input and output buttons.
  - For matrix sizes **above** 1616, input buttons light green.
  - For matrix sizes **up to** 1616, input buttons light one of the following colors:
    - **Amber:** Video and audio ties
    - **Green:** Video only ties
    - **Red:** Audio only ties
  - Output buttons light or blink one of the following colors:
    - **Amber:** Video and audio ties
    - **Green:** Video only ties
    - **Red:** Audio only ties
  - To indicate **potential ties**, output buttons **blink** the appropriate color when an input is selected.
  - To indicate **current ties**, output buttons **light steadily** the appropriate color when an input is selected.
  - To clear unwanted outputs, press and release the associated lit output buttons. To indicate **potential unties**, output buttons **blink** the appropriate color when an output is deselected but not untied from the input.
4. Press and release the Enter button to accept the tie or to break an existing tie.
5. Repeat steps 1 through 4 to create or clear additional ties until the desired configuration is complete.

### NOTES:

- Only one video input and one audio input can be tied to an output.
- If a tie is made between an input and an output, and the selected output was previously tied to another input, the older tie is broken in favor of the newer tie.
- If an input with no tie is selected, only the button for the selected input lights.
- When the RGBHV (CrossPoint switchers) or Video (MAV Plus switchers) button and Audio button are lit, if an input with an audio tie but no video tie is selected, the button for that input lights red (matrix sizes up to 1616) or green (matrix sizes 3232 and above) and the output button lights the appropriate color (amber, green, or red).
- As each input and output is selected, the associated output button blinks the appropriate color to indicate a tentative tie. Buttons for outputs that were already tied to the input light the appropriate color steadily. Outputs that are already tied can be left on, along with new blinking selections, or toggled off by pressing the associated output button.
- If you press the input button for an I/O grouped input and then try to select an output in a different group, you cannot select the associated output button (the action is ignored). The associated input button remains lit.

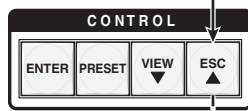


## Example 1: Create a set of video and audio ties

In the following example, input 5 is tied to outputs 3, 4, and 8. The steps show the front panel indications that result from your action.

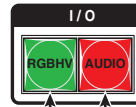
- 1. Clear all selections:** Press and release the Esc button.

Press the Esc button to clear all selections.



The button flashes once.

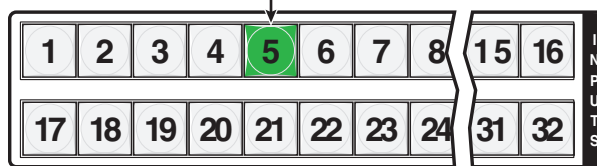
- 2. Select video and audio for the tie:** If necessary, press and release the RGBHV (CrossPoint switchers) or Video (MAV Plus switchers) button and the Audio button to light both.



Press the RGBHV or Video button to toggle on and off. Press the Audio button to toggle on and off.  
The button lights **green** when selected. The button lights **red** when selected.

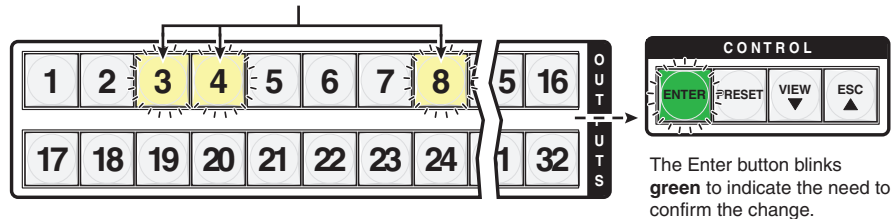
- 3. Select an input:** Press and release the input 5 button.

Press and release the Input 5 button.  
The button lights **amber** (matrix sizes up to 1616) or **green** (matrix sizes 2412 through 3232).



- 4. Select the outputs:** Press and release the output 3, output 4, and output 8 buttons.

Press and release the Output 3, Output 4, and Output 8 buttons.  
The buttons blink **amber** to indicate that the selected **RGBHV** or **video** and **audio** input will be tied to these outputs.



The Enter button blinks **green** to indicate the need to confirm the change.

**NOTE:** You can cancel the entire set of ties at this point by pressing and releasing the Esc button. The Esc button flashes once.

- 5. Confirm the change:** Press and release the Enter button.

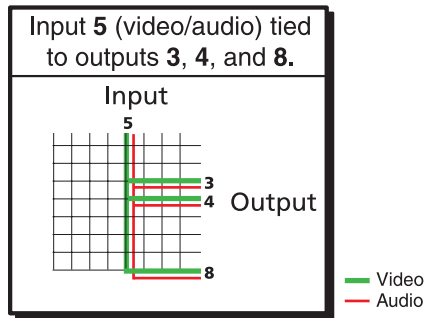
Press the Enter button to confirm the configuration change.



All **input buttons** and **output buttons** return to unlit or background illumination.

The Enter button returns to unlit or background illumination.

The current configuration (see figure 33) is now input 5 video and audio are tied to output 3, output 4, and output 8



**Figure 33.** Final Configuration, Example 1

### Example 2: Add a video tie to a set of video and audio ties

In the following example, a new video tie is added to the current configuration. The example shows the front panel indications that result from your actions.

**NOTE:** This example assumes that you have performed [example 1](#).

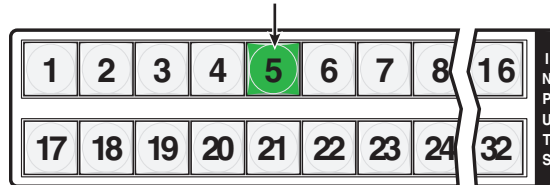
- 1. Clear all selections:** Press and release the Esc button.
- 2. Select video only for the tie:** Press and release the RGBHV (CrossPoint switchers) or Video (MAV Plus switchers) button and the Audio button as necessary to light Video only.



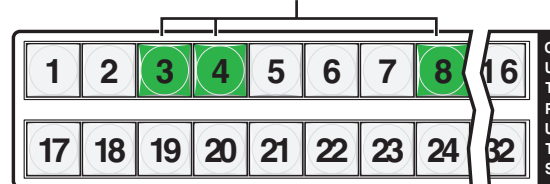
Press the RGBHV or Video button to toggle on and off. The button lights **green** when selected. Press the Audio button to toggle on and off. The button is **unlit** or **background illuminated** when deselected.

- 3. Select an input:** Press and release the Input 5 button.

Press and release the Input 5 button. The button lights **green** to indicate that **video** outputs can be tied to or untied from this input.

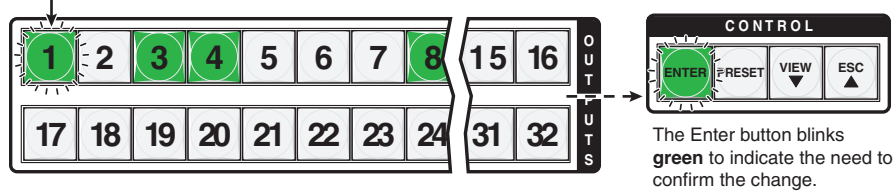


The Output 3, Output 4, and Output 8 buttons light **green** to indicate the **RGBHV** or **video** ties created in example 1.



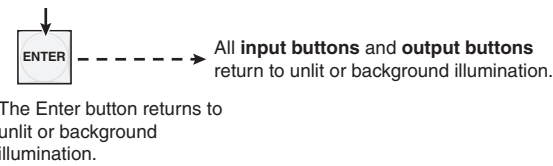
- 4. Select the output:** Press and release the Output 1 button.

Press and release the Output 1 button.  
The button blinks **green** to indicate that only the selected **RGBHV** or **video** input will be tied to this output.



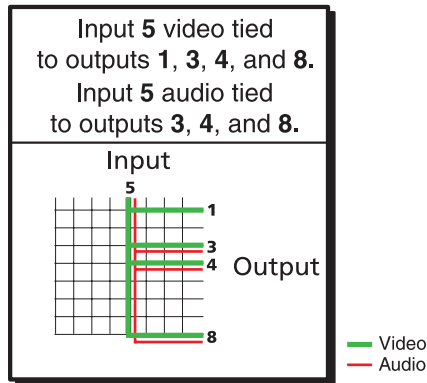
**5. Confirm the change:** Press and release the Enter button.

Press the Enter button to confirm the configuration change.



The current configuration (see figure 34) is now:

- **Video** — Input 5 video is tied to output 1, output 3, output 4, and output 8.
- **Audio** — Input 5 audio is tied to output 3, output 4, and output 8.



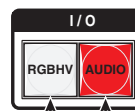
**Figure 34. Final Configuration, Example 2**

**Example 3: Remove a tie from a set of ties**

In the following example, an existing tie is removed from the current configuration. The example shows the front panel indications that result from your actions.

**NOTE:** This example assumes that you have performed **example 1** and **example 2**.

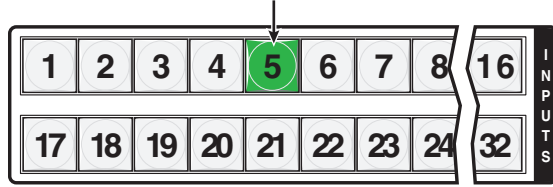
1. **Clear all selections:** Press and release the Esc button.
2. **Select audio only for the tie:** Press and release the RGBHV (CrossPoint switchers) or Video (MAV Plus switchers) button and the Audio button as necessary to light Audio only.



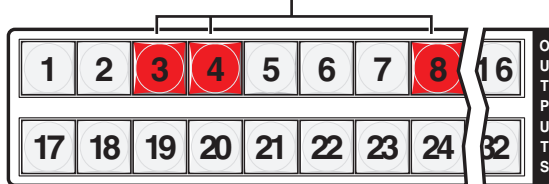
Press the RGBHV or Video button to toggle on and off. Press the Audio button to toggle on and off. The button is **unlit** or **background illuminated** when deselected. The button lights **red** when selected.

3. **Select an input:** Press and release the input 5 button.

Press and release the Input 5 button.  
 The button lights **red** (matrix sizes up to 1616)  
 or **green** (matrix sizes 2412 through 3232).



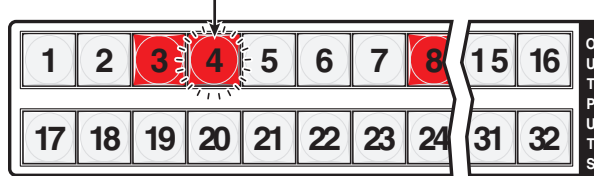
The Output 3, Output 4, and Output 8 buttons light **red** to indicate the **audio** ties created in example 1.



The Output 1 button **does not light** to indicate the tie created in example 2 because that tie is **RGBHV** or **video** only.

**4. Select the output:** Press and release the output 4 button.

Press and release the Output 4 button.  
 The button blinks **red** to indicate the pending change:  
**audio** input will be untied.



The Enter button blinks **green** to indicate the need to confirm the change.

**5. Confirm the change:** Press and release the Enter button.

Press the Enter button to confirm the configuration change.

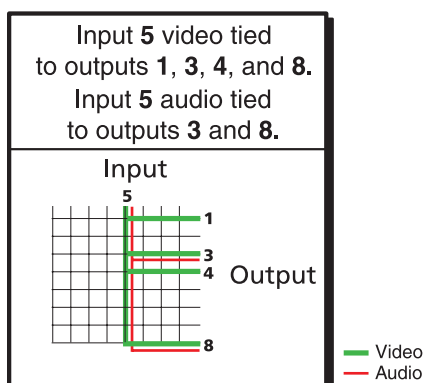


All **input buttons** and **output buttons** return to unlit or background illumination.

The Enter button returns to unlit or background illumination.

The current configuration (see figure 35) is now:

- **Video** — Input 5 video is tied to output 1, output 3, output 4, and output 8.
- **Audio** — Input 5 audio is tied to output 3 and output 8.



**Figure 35. Final Configuration, Example 3**

## Viewing the Configuration

The current configuration can be viewed using the front panel buttons. The *View-only* mode prevents inadvertent changes to the current configuration. View-only mode also provides a way to mute audio outputs (see [Muting and Unmuting Audio Outputs](#) on page 60).

View the current configuration as follows:

1. Press the Esc button to clear any input button indications, output button indications, or control button indications that may be on.
2. Press and release the View button. All of the buttons light for outputs that are **not** tied as follows:
  - **Amber:** No tied video **or** audio input
  - **Green:** No tied video input
  - **Red:** No tied audio input

If you press an output button for which there are no ties, the output buttons light for all outputs without ties.

3. Select video, audio, or both to view by pressing the RGBHV (CrossPoint switchers) or Video (MAV Plus switchers) button, Audio button, or both.

- Select the desired input or output whose ties you wish to view by pressing the input or output button.

**NOTES:**

- When you enter View-only mode, the output buttons light for all outputs without ties. Likewise, when you press an output button for which there are no ties, the output buttons light for all outputs without ties.
- To see all ties of the current configuration, press and release each input and output button, one at a time, with the RGBHV (CrossPoint switchers) or Video (MAV Plus switchers) button and the Audio button lit.
- In View-only mode, you can view video and audio, video-only, or audio-only ties. Pressing and releasing the RGBHV (CrossPoint switchers) or Video (MAV Plus switchers) button and the Audio button toggles each selection on and off.
- When you view video and audio ties, the RGBHV (CrossPoint switchers) or Video (MAV Plus switchers) button is lit green and the Audio button is lit red. After you select an input or output, the output buttons light different colors to show where video and audio ties are not the same (audio is broken away).
  - Amber:** Video and audio
  - Green:** Video only
  - Red:** Audio only.
- After 30 seconds of front panel inactivity, *View-only* mode automatically deselects.

**Example 4: Viewing video and audio, audio only, and video only ties**

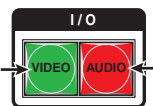
In the following example, we view the video and audio, audio only, and video-only ties in the current configuration. The steps show the front panel indications that result from your action.

**NOTE:** This example assumes that you have performed [example 1](#), [example 2](#), and [example 3](#).

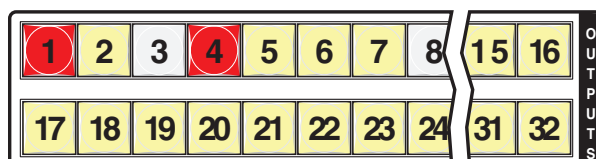
- Clear all selections:** Press and release the Esc button.
- Select View-only mode:** Press and release the View button. The View button lights red.
- Select video and audio for viewing:** Press and release the RGBHV (CrossPoint switchers) or Video (MAV Plus switchers) button and the Audio button as necessary to light both.

Press the RGBHV or Video button to toggle on and off. The button lights **green** when selected.

Press the Audio button to toggle on and off. The button lights **red** when selected.

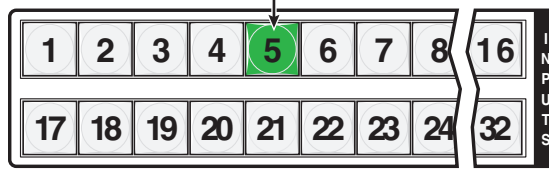


Until you select an input, the buttons for all untied outputs light **amber** if **no inputs** are tied, **green** if **no video inputs** are tied (only audio is tied), or **red** if **no audio inputs** are tied (only video is tied).



**4. Select an input:** Press and release the input 5 button.

Press and release the Input 5 button.  
The button lights **amber** (matrix sizes up to 1616) or **green** (matrix sizes 2412 through 3232).



The output buttons for outputs that **are** tied to Input 5 light the appropriate color:

- **Amber** for **audio** and **RGBHV** or **video** ties (audio follow)
- **Green** for **RGBHV** or **video** ties (audio breakaway)
- **Red** for **audio** ties (audio breakaway)



The output buttons for outputs that are **not** tied to Input 5 are either unlit or background illuminated.

**NOTE:** You can also view a set of ties by selecting a tied output. Demonstrate this as follows:

- Note the number of a lit output button, and then press and release the output button for an untied (unlit or background illumination) output.
- Observe that all of the untied outputs light.
- Then press the output button that you noted previously
- Observe that the selected output button, the tied input button (input 5), and the output buttons light for all of the outputs that are tied to the input.

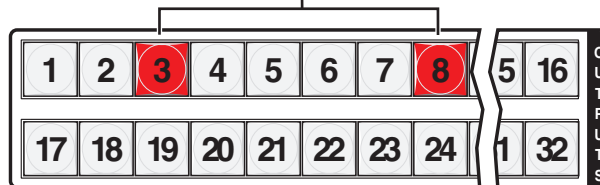
**5. Deselect video:** Press and release the RGBHV (CrossPoint switchers) or Video (MAV Plus switchers) button.

Press the RGBHV or Video button to deselect it.  
The button is unlit or background illuminated when deselected.



The Audio button remains lit **red** to indicate that only **audio** is selected.

The output buttons for outputs that **are** tied to Input 5 light or blink **red** to indicate **audio** ties (audio breakaway).

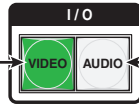


The output buttons for outputs that are **not** tied to Input 5 are either unlit or background illuminated.

**6. Toggle audio off and video on:** Press and release the RGBHV (CrossPoint switchers) or Video (MAV Plus switchers) button and the Audio button.

Press the RGBHV or Video button to select it.

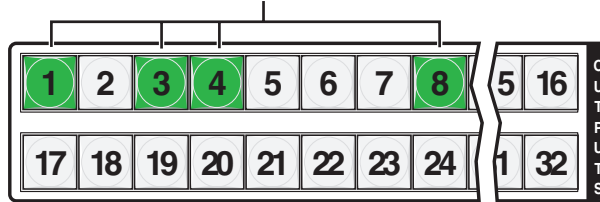
The button lights **green** when selected.



Press the Audio button to deselect it.

The button is **unlit** or **background illuminated** when deselected.

The output buttons for outputs that **are** tied to Input 5 light **green** to indicate **RGBHV/Video** ties (audio breakaway).



The output buttons for outputs that are **not** tied to Input 5 are either unlit or background illuminated.

If video ties are established for input 5, the output buttons light green for all video outputs tied to input 5. If no ties are established for input 5, all output buttons return to either unlit or to background illumination.

**7. Exit View-only mode:** Press and release the View button

Press the View button to exit *View-Only* mode.



All **input buttons** and **output buttons** return to unlit or background illumination.

The View button returns to unlit or background illumination.



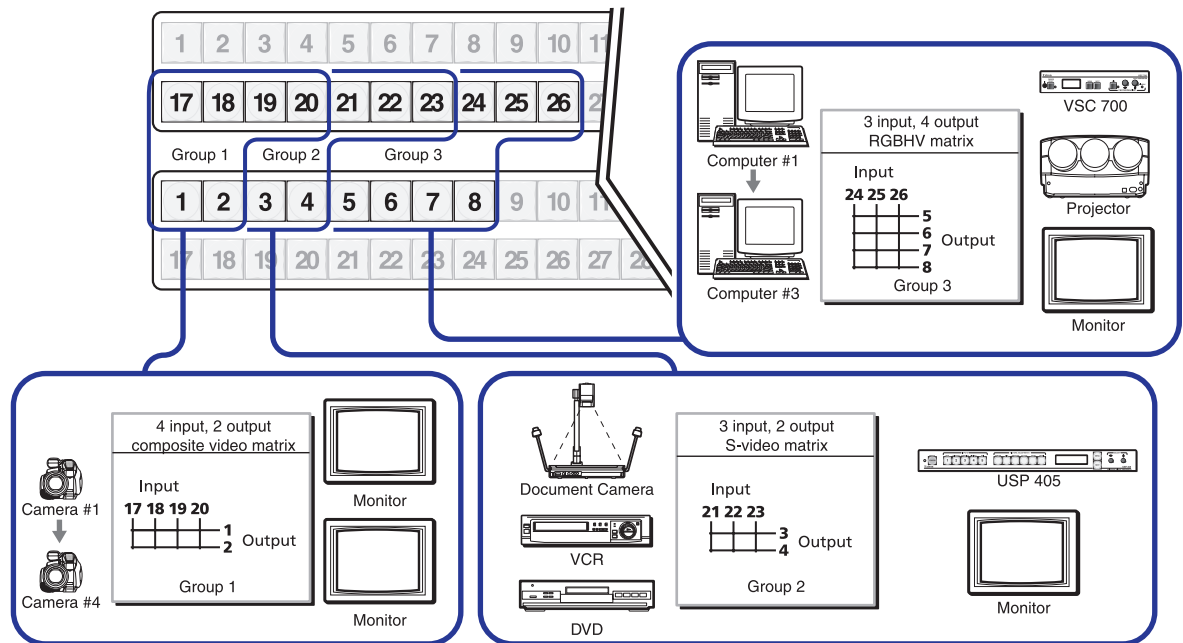
## I/O Grouping

I/O grouping is a matrix switcher feature that allows you to subdivide the front panel controls of the matrix into four smaller functional sub-switchers and limit tie creation **using the front panel only**. Tie creation via remote control is unaffected. Inputs and outputs can be assigned to one of four groups or not assigned to any group.

When you are creating ties on the front panel, inputs and outputs that are assigned to a group can be tied only to other outputs and inputs within the same group. For example, a front panel operator cannot tie an input that is assigned to group 1 to an output that is assigned to group 2. Ungrouped inputs and outputs can be switched to outputs and inputs in any group. Ties between groups (an input in group 1 tied to an output in group 2) **can** be created under serial port or Ethernet control.

Suggested applications for the I/O grouping feature include:

- Segregating specific video formats to prevent an input in one video format from being inadvertently applied to an output device that supports another video format (see figure 36)
- Segregating input and output devices that are in separate rooms
- Isolating video from being displayed on specific output devices for operational security reasons

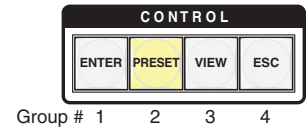


**Figure 36. I/O Grouping of Incompatible Video Formats**

The I/O groups can be set up on the front panel or by using serial port or LAN port control and either the SIS (see [page 102](#)) or the Windows control program (see [page 126](#)). Create I/O groups on the front panel as follows:

**NOTE:** I/O groups are protected when front panel lock mode 2 is selected. You can view the groups in lock mode 2, but you cannot change them from the front panel (see [Setting the Front Panel Locks \(Executive Modes\)](#) on page 75).

1. Press the Esc button to clear any input buttons, output buttons, or control buttons that may be lit.
2. To enter *I/O Group* mode, press and **hold** the Input 1 and Output 1 buttons simultaneously until the input and output buttons light to display the ungrouped inputs and outputs. Release the buttons.
3. Press and release one of the Control buttons to select a group:
  - Press the Enter button to select group 1.
  - Press the Preset button to select group 2.
  - Press the View button to select group 3.
  - Press the Esc button to select group 4.
4. Select one or more desired inputs and one or more outputs to assign to the group by pressing the input and output buttons.
5. Press and release the RGBHV or Video button and Audio button to exit the *I/O Group* mode, or allow the mode to time out after approximately 30 seconds.



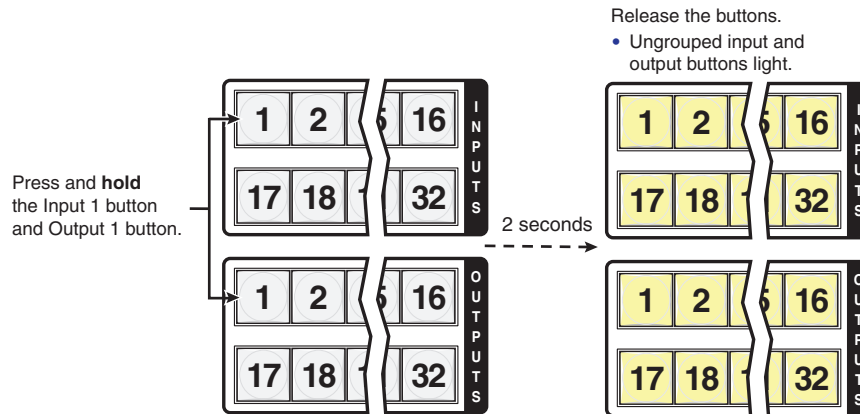
#### NOTES:

- Ties that were created before I/O groups were created remain valid, even if they include inputs and outputs in different groups.
- For I/O groups to be meaningful (have any function), at least two groups must be created.
- Presets can be created under serial port or Ethernet control that tie inputs and outputs across group boundaries. These presets are selectable from the front panel.
- An input or output can be assigned to only one group. If you assign an input or output to a group and that input or output is already assigned to a different group, the older grouping is discarded in favor of the new grouping.
- You can break audio away from the video for a given input or output (assigned to different groups) by isolating only video or only audio using the front panel RGBHV (CrossPoint) or Video (MAV Plus) button and the Audio button after you select I/O Group mode (between steps 2 and 3).
- Audio breakaway across different groups can be confusing when you are operating the front panel. Breakaway grouping is not displayed by the Matrix Switchers Control Program, HTML pages, or SIS commands; and is not recommended (breakaway ties, once created, are displayed).
- Ties between groups (an input in group 1 tied to an output in group 2) **can** be created under serial port or Ethernet control.

## Example 5: Grouping inputs and outputs

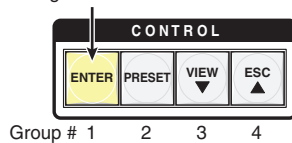
In the following example, several switcher inputs and outputs are assigned to groups. The steps show the front panel indications that result from your action.

1. **Clear all selections:** Press and release the Esc button.
2. **Enter I/O Group mode:** Press and **hold** the Input 1 and Output 1 buttons for approximately 2 seconds and then release the buttons.



3. **Select group 1:** Press and release the Enter button.

Press and release the Enter button to select group 1. The button lights to indicate the selection.



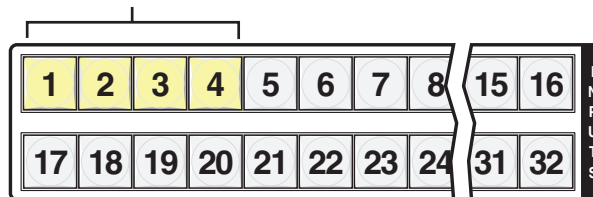
**NOTE:** I/O groups are protected when front panel lock mode 2 is selected. You can view the groups in lock mode 2, but you cannot change them from the front panel (see [Setting the Front Panel Locks \(Executive Modes\)](#) on page 75).

If front panel lock mode 2 is selected and you try to perform step 4, the actions are ignored and the Enter, RGBHV or Video, and Audio buttons flash.

4. **Assign inputs and outputs to group 1:**

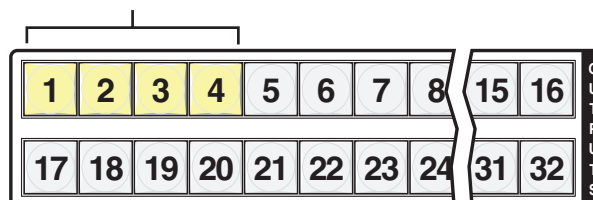
- a. Press and release the Input 1 through 4 buttons.

Press and release the Input 1 through Input 4 buttons. The selected buttons light.



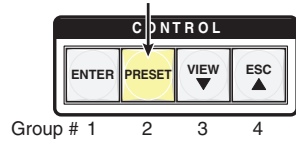
- b. Press and release the Output 1 through 4 buttons.

Press and release the Output 1 through Output 4 buttons. The selected buttons light.



**5. Select group 2:** Press and release the Preset button.

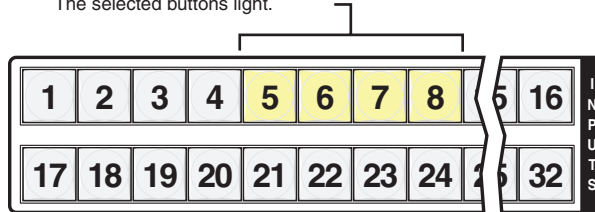
Press and release the Preset button to select group 2.  
The button lights to indicate the selection.



**6. Assign inputs and outputs to group 2:**

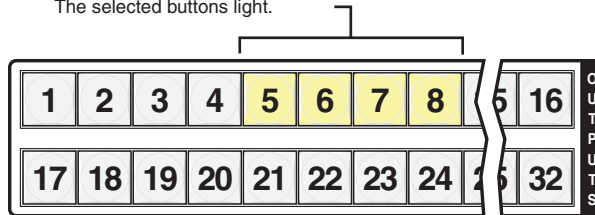
**a.** Press and release the Input 5 through 8 buttons.

Press and release the Input 5 through Input 8 buttons.  
The selected buttons light.



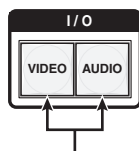
**b.** Press and release the Output 5 through 8 buttons.

Press and release the Output 5 through Output 8 buttons.  
The selected buttons light.



**7. Exit I/O Group mode:** Simultaneously press and release the RGBHV (CrossPoint switchers) or Video (MAV Plus switchers) button and Audio button.

**NOTE:** As an alternative, if you do not push any front panel buttons for approximately 30 seconds, the front panel times out and the switcher exits I/O Group mode.



Press and release both buttons.

- Group 1 consists of inputs 1 through 4 and outputs 1 through 4.
- Group 2 consists of inputs 5 through 8 and outputs 5 through 8.

## Setting RGB Delay (CrossPoint Switchers)

The CrossPoint 450 Plus and CrossPoint Ultra switchers can briefly blank the RGB (video) output while it switches to the sync source of the new input, and then switches the RGB signals. This allows a brief delay for the display to adjust to the sync timing of the selected input before displaying the new picture, which will appear without glitches. RGB delay, also known as Triple-Action Switching or video mute switching, is user selectable from 0 to 5 seconds, in half-second increments.

The RGB delay interval can be set on the front panel or by using either serial port or the Ethernet port and either an SIS command (see [page 101](#)), Windows control program (see [page 125](#)), or HTML pages (see [page 145](#)).

Specify the RGB delay interval for a specific output on the front panel as follows:

**NOTE:** RGB delay is protected when front panel lock mode 2 is selected. You can view the delay in lock mode 2, but not change it from the front panel (see [Setting the Front Panel Locks \(Executive Modes\)](#) on page 75).

1. Press the Esc button to clear any input buttons, output buttons, or control buttons that may be lit.
2. To enter *RGB Delay* mode, press and **hold** the RGBHV button until the button begins to blink green, then release the button.
3. Press and release an output button to select an output. Each lit input button, from Input 1 through Input 10, indicates a half second of RGB delay interval for the selected output.
4. Press and release the Esc (▲) and View (▼) buttons to increase and decrease the interval.
5. Press and release the RGBHV button to exit the *RGB Delay* mode. The RGBHV button stops blinking.

### NOTES:

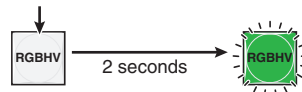
- Pressing the Enter or Preset button also exits RGB Delay mode. Pressing the Preset button changes to Recall Preset mode.
- The RGB interval for each output is stored in non-volatile memory. When power is removed and restored, the delay settings are retained.
- Exiting RGB Delay mode by pressing the RGBHV button always returns the I/O configuration to audio only selected for configuration.

### Example 6: Setting the RGB delay for an output

In the following example, the RGB delay is increased for output 17. The steps show the front panel indications that result from your action.

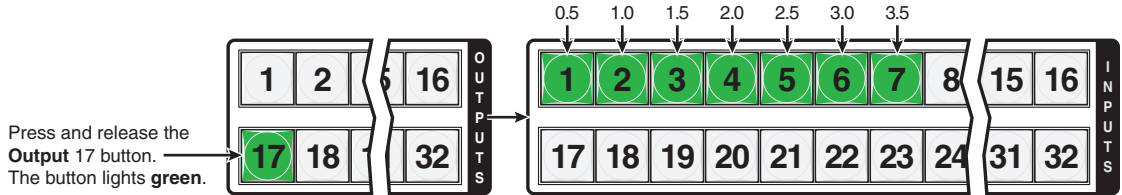
1. **Clear all selections:** Press and release the Esc button.
2. **Enter *RGB Delay* mode:** Press and **hold** the RGBHV button for approximately 2 seconds.

Press and hold the RGBHV button until it blinks.



**3. Select an output:** Press and release the Output 17 button.

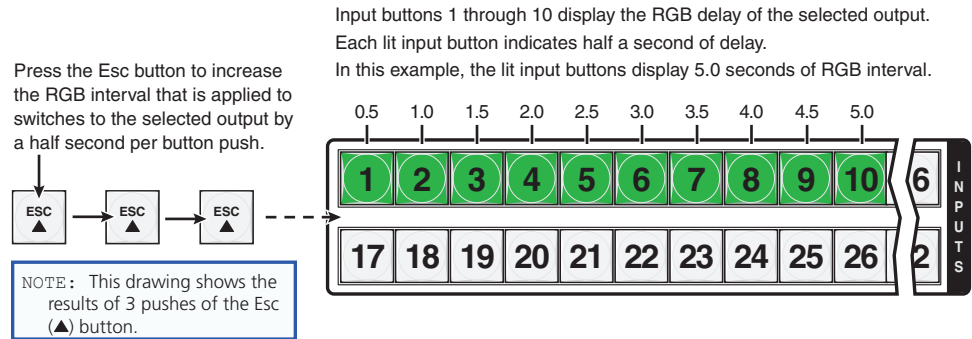
The input buttons 1 through 10 display the RGB delay of the selected output.  
 Each lit input button indicates half a second of delay.  
 In this example, the lit input buttons display 3.5 seconds of RGB delay.



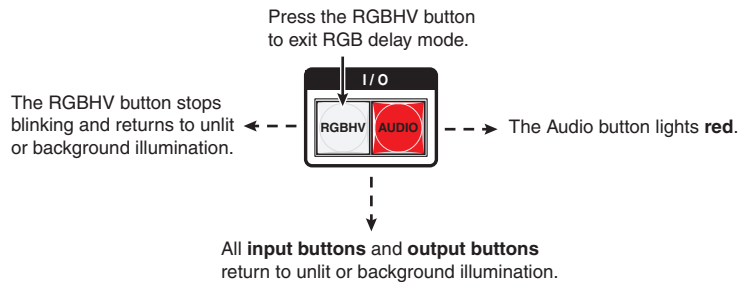
**NOTE:** The RGB delay is protected when front panel lock mode 2 is selected. You can view the groups in lock mode 2, but you cannot change them from the front panel (see [Setting the Front Panel Locks \(Executive Modes\)](#) on page 75). If front panel lock mode 2 is selected and you try to perform step 4, the actions are ignored and the Enter, RGBHV or Video, and Audio buttons flash.

**4. Adjust the RGB delay:** Press and release the Esc (▲) button once to increase the RGB delay by a half second.

Press and release the Esc (▲) button twice more to increase the RGB delay by a whole second. Note the input button indication changes that occur each time the Esc (▲) button is pressed and released.



**5. Exit RGB Delay mode:** Press and release the RGBHV button.

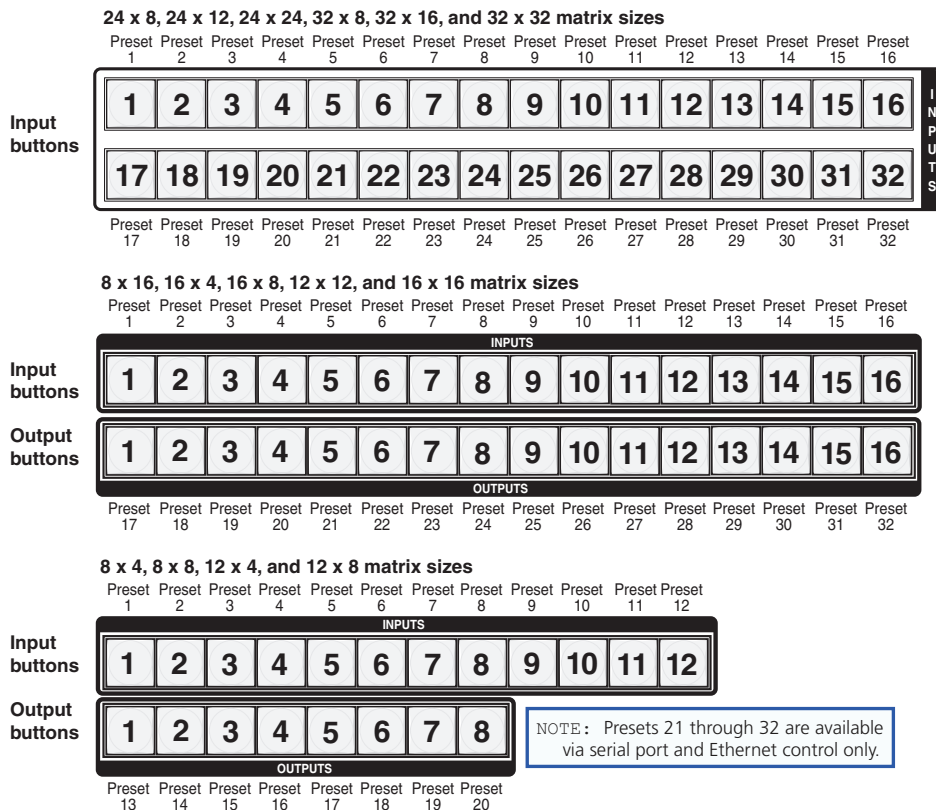


## Using Presets

The current configuration (configuration 0) can be saved as a preset in any one of 32 preset memory addresses. All 32 presets are assigned to the input buttons and (where necessary) output buttons and are available to be either saved or retrieved from the front panel. All 32 presets can be selected from the front panel to be either saved or retrieved. When a preset is retrieved from memory, it becomes the **current configuration**.

### NOTES:

- Only the audio and video ties are stored and recalled; RGB delay and audio gain and volume settings are not saved, and they do not change when a preset is recalled.
- Presets **cannot** be viewed from the front panel unless they are recalled as the current configuration. Presets can be viewed using the Matrix Switchers Control Program (see [page 124](#)).
- The current configuration and all presets are stored in non-volatile memory. When power is removed and restored, the current configuration is still active and all presets are retained.
- When a preset is recalled, it replaces the current configuration, which is lost unless it is also stored as a preset. The recalled preset overwrites all of the current configuration ties in favor of the preset configuration ties.
- All models have 32 presets; on models with fewer than 32 input and output buttons, preset numbers that are too high to be available from the front panel are still accessible under serial port or Ethernet control.
- Figure 37 shows the presets associated with the three input and output button configurations for the CrossPoint and MAV matrix switchers.

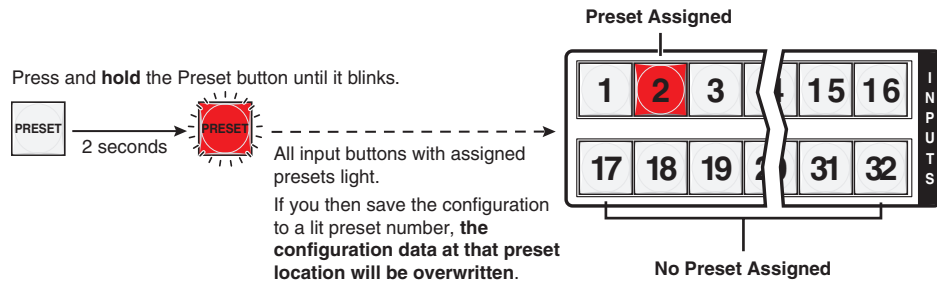


**Figure 37. CrossPoint or MAV Plus 1600 Preset Locations**

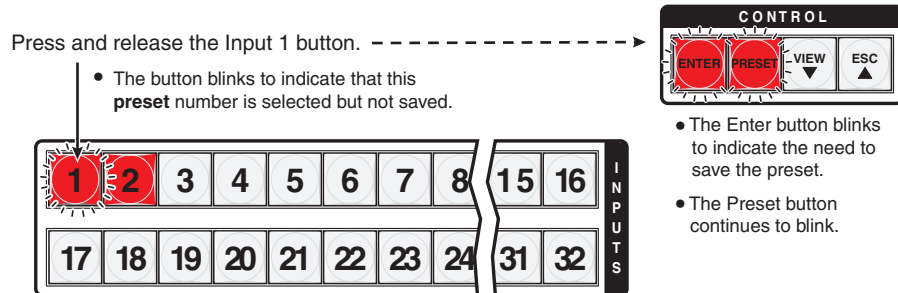
## Example 7: Saving a preset

In the following an example, the current configuration is saved as a preset. The example shows the front panel indications that result from your actions.

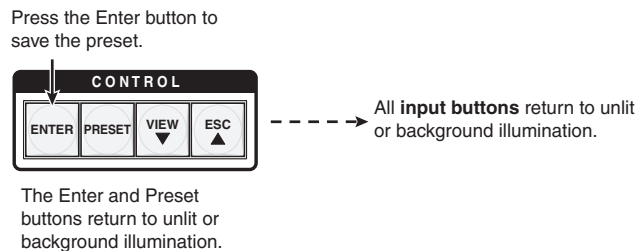
- 1. Clear all selections:** Press and release the Esc button.
- 2. Select Save Preset mode:** Press and **hold** the Preset button for approximately 2 seconds until it blinks.



- 3. Select the preset:** Press and release the input button or output button for the desired preset.



- 4. Save the preset:** Press and release the Enter button to save the preset. The current configuration is now stored in the selected memory location.

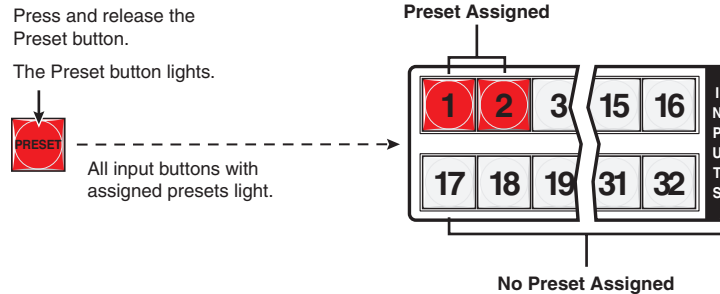




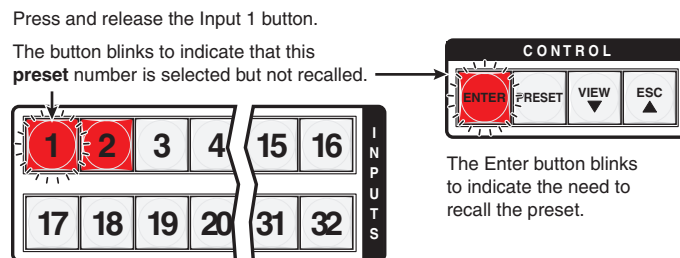
## Example 8: Recalling a preset

In the following example, a preset is recalled to become the current configuration. The steps show the front panel indications that result from your action.

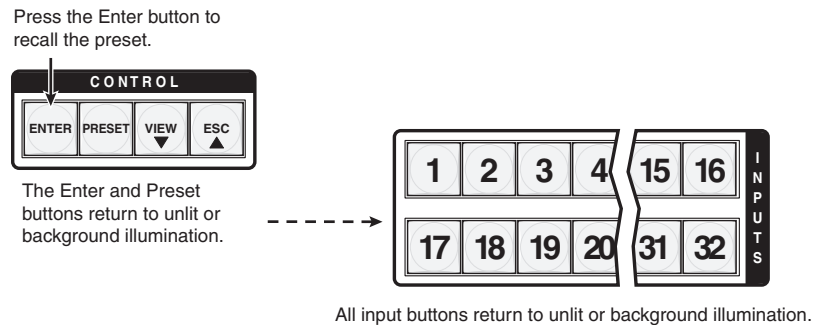
- 1. Clear all selections:** Press and release the Esc button.
- 2. Select Recall Preset mode:** Press and release the Preset button.



- 3. Select the preset:** Press and release the input button or output button for the desired preset.



- 4. Recall the preset:** Press and release the Enter button. The configuration stored in the selected memory location is now the current configuration and can be viewed in the *View-only* mode (see [example 4](#) on page 48).



## Muting and Unmuting Video and Audio Outputs

Individual outputs can be muted or unmuted as follows:

**NOTE:** Output mutes are protected when front panel *Lock* mode 2 is selected. You can view the status of the output (muted or unmuted) in *Lock* mode 2 but you cannot change it from the front panel (see **Setting the Front Panel Locks (Executive Modes)** on page 75).

1. Press the Esc button to clear any input button indications, output button indications, or control button indications that may be on.
2. Press and release the View button.
3. Select video, audio, or both to mute or unmute by pressing the RGBHV (CrossPoint switchers) or Video (MAV Plus switchers) button and the Audio button.
4. One at a time, press and **hold** the buttons for the desired outputs for approximately 2 seconds. The output buttons for the selected outputs blink to indicate the mute or return to their previous state to indicate the unmute.
5. Press and release the View button to return to normal switcher operation.

### NOTES:

- You can mute video and audio, video-only, or audio-only outputs. Pressing and releasing the RGBHV (CrossPoint switchers) or Video (MAV Plus switchers) button and the Audio button toggles each selection on and off.
- When you enter *View-only* mode, the output LEDs turn **on** for all outputs **without** ties.
- On CrossPoint switchers, the video mute function mutes the R, G, and B planes only; the H and V planes are still active. On MAV Plus switchers, the video mute function mutes all video planes.
- Mutes are saved to non-volatile memory. When power is removed and restored, the mute settings are retained.

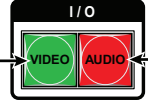
## Example 9: Muting and unmuting an audio output

In the following example, several switcher outputs are muted and unmuted. The steps show the front panel indications that result from your action.

- 1. Clear all selections:** Press and release the Esc button.
- 2. Select *View-only* mode:** Press and release the View button. The View button lights red.
- 3. Select both video and audio for viewing and muting:** If necessary, press and release the RGBHV (CrossPoint switchers) or Video (MAV Plus switchers) button and the Audio button.

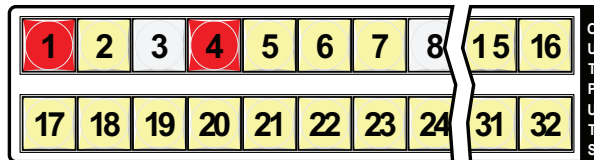
**NOTE:** This example assumes that, and shows the front panel indications if, you have performed [example 1](#), [example 2](#), and [example 3](#).

Press the RGBHV or Video button to toggle on and off. The button lights **green** when selected.



Press the Audio button to toggle on and off. The button lights **red** when selected.

Until you select an input, the buttons for all untied outputs light **amber** if **no inputs** are tied, **green** if **no video inputs** are tied (only audio is tied), or **red** if **no audio inputs** are tied (only video is tied).

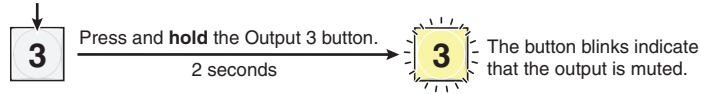


**NOTE:** Output mutes are protected when front panel *Lock* mode 2 is selected. You can view the mutes in *Lock* mode 2 but you cannot change them from the front panel (see [Setting the Front Panel Locks \(Executive Modes\)](#) on page 75). If front panel *Lock* mode 2 is selected and you try to perform steps 4 and 5, the actions are ignored.

**4. Mute outputs:** One at a time:

- a. Press and **hold** the Output 3 button for approximately 2 seconds until the button begins to blink.
- b. Press and **hold** the Output 4 button for approximately 2 seconds until the button begins to blink.

**Mute outputs one at a time.**



**NOTE:** Video is muted in this example.

**Green = Video** is muted.

**Red = Audio** is muted.

**Amber = Video and audio** are muted. (*Amber is visible only after you have selected the Video and Audio buttons*).



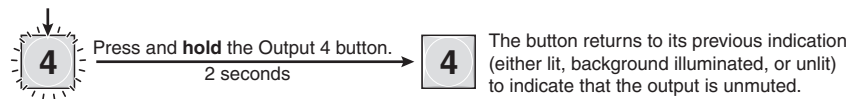
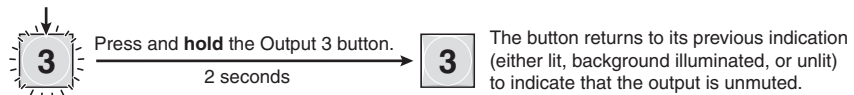
**NOTES:**

- If both video and audio are selected, the mute action toggles both the video and audio outputs. If either the video output or the audio output is already muted, the unmuted output is muted and the muted output is unmuted.
- If both video and audio are selected and only video is muted, the output button flashes between green and amber. If only audio is selected, the output button flashes between red and amber.

**5. Mute outputs:** One at a time:

- a. Press and **hold** the Output 3 button for approximately 2 seconds until the button returns to its previous state. The output 3 video and audio signals are unmuted.
- b. Press and **hold** the Output 4 button for approximately 2 seconds until the button returns to its previous state. The output 4 video and audio signals are unmuted.

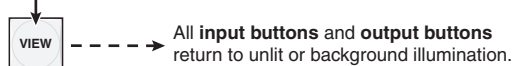
**Unmute outputs one at a time.**



**NOTE:** If both video and audio are selected, the unmute action toggles both the video and audio outputs. If either the video output or the audio output is already unmuted, the muted output is unmuted and the unmuted output is muted.

**6. Exit View-only mode:** Press and release the View button.

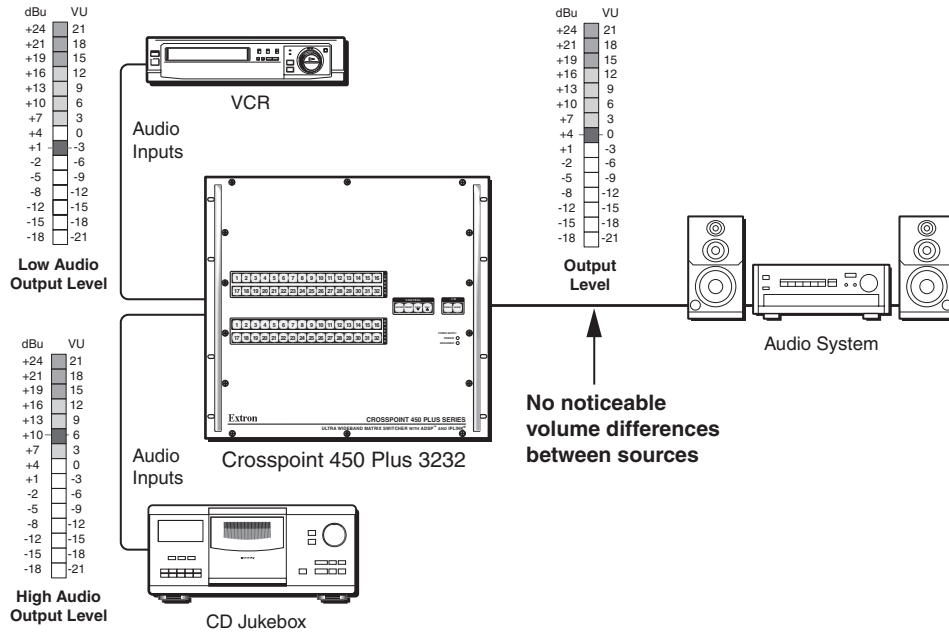
Press the View button to exit *View-Only* mode.



The View button returns to unlit or background illumination.

## Viewing and Adjusting the Input Audio Level (Audio Models)

On models with audio, the level of each analog audio input can be displayed and adjusted through a range of -18 dB to +24 dB to ensure that there is no noticeable volume difference among sources (see figure 38). The audio level can be adjusted from the front panel or under remote control. The default audio level is 0 dB.



**Figure 38. Audio Gain and Attenuation**

1. Press the Esc button to clear any input buttons, output buttons, or control buttons that may be lit.
2. To enter *Audio* mode, press and **hold** the Audio button until the button begins to blink red, then release the button.
3. Press and release an input button to select an input that has analog audio. The output buttons display the audio level for the selected input; the more output LEDs lit, the greater the gain or attenuation.

- **Green** output buttons indicate a **gain** (+) audio level.
- **Red** output buttons indicate an **attenuation** (-) level.

Audio gain and attenuation is displayed differently on different models.

- **Switchers with 32 output buttons** — Each output button indicates 1 dB when lit. See [table 2](#) on the next page.
  - **Switchers with 16 output buttons** — Each output button indicates 1 dB when blinking and 2 dB when lit. See [table 3](#) on page 65.
  - **Switchers with 8 output buttons** — Each output button indicates 1 dB when blinking slowly, 2 dB when blinking quickly, and 3 dB when lit. See [table 3](#) on page 65.
4. Press and release the Esc (▲) and View (▼) buttons to increase and decrease the audio level.



**Table 3. 8-output Button and 16-output Button Audio Gain and Attenuation Display**

dB	Audio models in matrix sizes: 84, 88, 124, 128 Output LED Indication	dB	Audio models in matrix sizes: 816, 1212, 1616 Output LED Indication
24		24	
23		23	
22		22	
21		21	
20		20	
19		19	
18		18	
17		17	
16		16	
15		15	
14		14	
13		13	
12		12	
11		11	
10		10	
9		9	
8		8	
7		7	
6		6	
5		5	
4		4	
3		3	
2		2	
1		1	
0		0	

= Unlit button   
 = Lit button   
 = Blinking button   
 = Slow blinking button  
 Green indicates a positive (gain) level.   
 Red indicates a negative (attenuation) level.   
 = Fast blinking button

### Example 10: Viewing and adjusting an input audio level

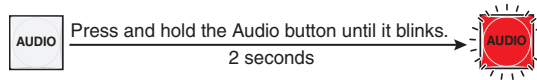
Because of the different gain and attenuation display schemes, the input audio levels that result from the following example are shown two times:

- As displayed on a 32-output button switcher
- As displayed on a 16-output button switcher
- As displayed on an 8-output button switcher

The 32-button drawings show the actions that lead up to the display and the display itself. For simplicity, the 16-button and 8-button drawings show the attenuation display only, not the actions that lead to it.

In the following example, an audio level is viewed and adjusted. The steps show the front panel indications that result from your action.

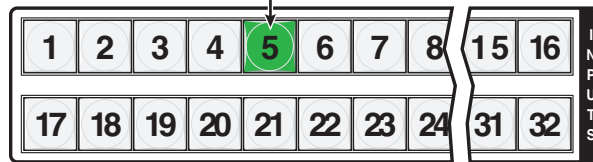
1. **Clear all selections:** Press and release the Esc button.
2. **Select Audio mode:** Press and **hold** the Audio button for approximately 2 seconds until it blinks.



3. **Select an input:** Press and release the Input 5 button (see figure 39).

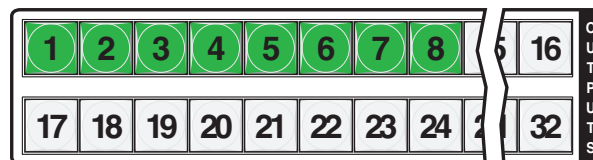
Figure 39, figure 40, and figure 41 show an audio gain level of +8 dB.

Press and release the Input 5 button.  
The button lights green.



The output buttons display the audio level and polarity (gain or attenuation) of the selected input.

- Each output button indicates 1 dB when lit.  
When the buttons are lit **green**, they indicate a **gain (+)** audio level.  
When the output buttons are lit **red**, they indicate an **attenuation (-)** level.
- In this example, the output buttons display an audio gain level of +8 dB.



**Figure 39. Select an Input**

Figure 40 shows the same level (+8 dB) as in figure 39, but displayed on a 16-output-button switcher, such as a MAV Plus 816.

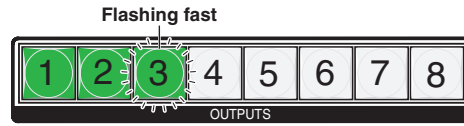


In this example, the output buttons display an audio gain level of +8 dB.

**Figure 40. Level Display on a 16-output-button Switcher**



Figure 41 shows the same level (+8 dB) as in figure 39, but displayed on an 8-output-button switcher, such as a MAV Plus 84 HDA.



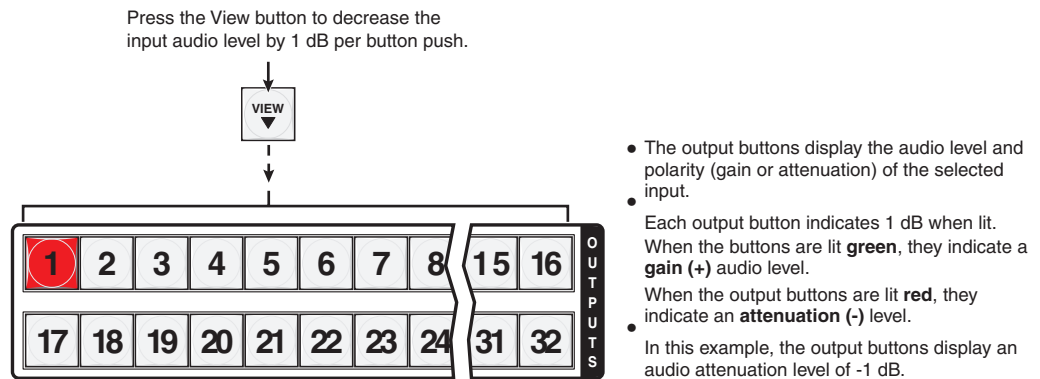
In this example, the output buttons display an audio gain level of +8 dB.

**Figure 41. Level Display on a 8-output-button Switcher**

- 4. Change the audio level:** Press and release the View (▼) button once (see figure 42) to decrease the input audio level by 1 dB.

Press and release the View (▼) button several more times (see figure 42) to decrease the input audio level by 1 dB per button press. Note the output button indication changes that occur each time the View (▼) button is pressed.

Figure 42 shows the result of pressing the View (▼) button a total of nine times, an audio attenuation level of -1 dB. Note that the level is now displayed in red to indicate a negative level.



**Figure 42. Adjust the Analog Input Audio Level**

Figure 43 shows the same level (-1 dB) as in figure 42, but displayed on a 16-output-button switcher, such as a MAV Plus 1616 A.

**Blinking**



In this example, the output buttons display an audio gain level of -1 dB.

**Figure 43. Level Display on a 16-output-button Switcher**

Figure 44 shows the same level (-1 dB) as in figure 42, but displayed on a 8-output-button switcher, such as a CrossPoint Ultra 128 HVA.

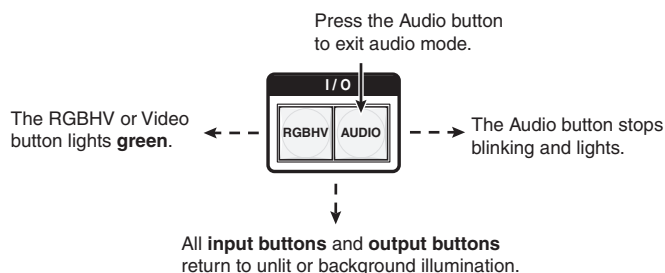
**Slowly Blinking**



In this example, the output buttons display an audio gain level of -1 dB.

**Figure 44. Level Display on a 8-output-button Switcher**

5. **Exit *Audio* mode:** Press and release the Audio button.



## Viewing and Adjusting the Analog Output Volume (Audio Models)

On models with audio, the level of each analog audio output can be displayed and adjusted through a range of 100% (no attenuation) to 0% (maximum [76 dB] attenuation). The audio level can be adjusted from the front panel or under serial port or Ethernet control. The default volume is 100% (no attenuation).

**NOTE:** Output volume is protected when front panel *Lock* mode 2 is selected. You can view the volume in *Lock* mode 2 but you cannot adjust it from the front panel (see [Setting the Front Panel Locks \(Executive Modes\)](#) on page 75).

1. Press the Esc button to clear any input buttons, output buttons, or control buttons that may be lit.
2. To enter *Audio* mode, press and **hold** the Audio button until the button begins to blink red, then release the button.
3. Press and release an output button to select an output. The input buttons display the volume level for the selected output. The switchers indicate the volume differently, depending on number of input buttons, but as a general rule, the more buttons that are lit, the higher the volume. The fewer buttons that are lit, the lower the volume.

For a more detailed analysis of decoding the displayed value, see [Reading the displayed volume](#), on the next page.

4. Press and release the Esc (▲) and View (▼) buttons to increase and decrease the audio volume.
5. Press and release the Audio button to save the audio settings and exit the *Audio* mode. The Audio button stops blinking.

### NOTES:

- There is one audio volume level setting per analog output. The audio level setting is shared by the left and right audio inputs.
- The audio volume levels are stored in non-volatile memory. When power is removed and restored, the audio level settings are retained.
- Exiting *Audio* mode by pressing the Audio button always returns the I/O buttons to Video lit green and Audio lit red.
- Pressing the Enter or Preset button also exits *Audio* mode. Pressing the Preset button changes to *Recall Preset* mode.

## Reading the displayed volume

**NOTE:** This section is a detailed look at reading the output volume display on the front panel. If you do not need to read the exact value of the volume setting, skip this section.

There are 65 steps of volume attenuation, with 1 dB per step (button push), except for 0-to-1, which is 13 dB. At maximum attenuation, no input buttons are lit, 76 dB of attenuation is applied, and the audio output is effectively muted. At no attenuation, all input buttons are lit and the output volume is equal to the input signal (plus any gain or attenuation that is applied to that specific input using the input audio level adjustment [see [Viewing and Adjusting the Input Audio Level \(audio models\)](#), on page 63]). Other than the minimum and maximum volume, the switchers indicate the volume differently, depending on the model (see [table 4](#) on the next page to read the volume display for each display scheme).

For each display scheme, the input buttons blink or light sequentially to indicate the approximate volume of the selected output. Volume is defined as a percentage of the input audio signal that is applied to the output. From 0% of volume, the first Esc (▲) button push applies 5.5% of the input audio signal. From 5.5% on, each Esc (▲) push applies 1.5% more of the input audio signal to the output:

- **Push Esc (▲) button again** —  $5.5\% + 1.5\% = 7\%$  volume
  - **Switchers with 12 and 16 input buttons** — The Input 1 button blinks slowly
  - **Switchers with 32 input buttons** — The Input 1 button lights steadily
- **Push Esc (▲) button twice more** —  $7\% + 1.5\% + 1.5\% = 10\%$  volume
  - **Switchers with 12 input buttons** — Indicated by the Input 1 button blinking quickly.
  - **Switchers with 16 input buttons** — Indicated by the Input 1 button lit steadily.
  - **Switchers with 32 input buttons** — Indicated by the Input 1 and Input 2 button lit steadily.
- **Push Esc (▲) button 19 times more** —  $10\% + (19 \text{ times } 1.5\%) = 38.5\%$  volume
  - **Switchers with 12 input buttons** — Indicated by the Input 1 through 4 buttons lit steadily.
  - **Switchers with 16 input buttons** — Indicated by the Input 1 through 5 buttons lit steadily and the Input 6 button blinking.
  - **Switchers with 32 input buttons** — Indicated by the Input 1 through Input 11 buttons lit steadily and the Input 12 button blinking.

When all input buttons are lit for any switcher model, the audio output is 100% of the audio input level.

**Table 4. Audio Volume Display**

Highest # input button lit			dB of attenuation	Output volume	Highest # input button lit			dB of attenuation	Output volume
12-input switcher	16-input switcher	32-input switcher			12-input switcher	16-input switcher	32-input switcher		
None	None	None	76	0%					
Slow blink			63	5.5%	Fast blink			31	53.5%
Fast blink				62	7%				30
Slow blink			61	8.5%	Slow blink			29	56.5%
				60			10%		28
Fast blink			59	11.5%	Fast blink			27	59.5%
				58			13%		26
Slow blink			57	14.5%				25	62.5%
				56			16%		24
Fast blink			55	17.5%	Slow blink			23	65.5%
				54			19%		22
Slow blink			53	20.5%	Fast blink			21	68.5%
				52			22%		20
Fast blink			51	23.5%	Slow blink			19	71.5%
				50			25%		18
Slow blink			49	26.5%	Fast blink			17	74.5%
				48			28%		16
Fast blink			47	29.5%				15	77.5%
				46			31%		14
Slow blink			45	32.5%	Slow blink			13	80.5%
				44			34%		12
Fast blink			43	35.5%	Fast blink			11	83.5%
				42			37%		10
Slow blink			41	38.5%	Slow blink			9	86.5%
				40			40%		8
Fast blink			39	41.5%	Fast blink			7	89.5%
				38			43%		6
Slow blink			37	44.5%				5	92.5%
				36			46%		4
Fast blink			35	47.5%	Slow blink			3	95.5%
				34			49%		2
Slow blink			33	50.5%	Fast blink			1	98.5%
				32			52%		0

= blinking LED

Another way to view the volume level is to think in terms of the attenuation that is applied to the output. Attenuation reduction is indicated by the lit or blinking input buttons: when fewer input buttons are lit, attenuation is greater (and the volume is quieter).

- At minimum volume, all input buttons are unlit or background illuminated and 76 dB of attenuation is applied to the output. The audio output is effectively muted.
- The first step of volume increase causes the Input 1 button to blink (slowly, in the case of switchers with 12 input buttons). Attenuation is reduced by 13 dB (63 dB of attenuation is applied to the output).
- The second step of volume increase reduces the attenuation by an additional 1 dB (62 dB of attenuation is applied to the output). (On switchers with 32 input buttons, the Input 1 button lights steadily.)
- Successive steps of volume increase cause consecutive input buttons to first blink and then light steadily. (On switchers with 32 input buttons, each consecutive button indicates a 1 dB **attenuation reduction** when blinking and a 2 dB **attenuation reduction** when lit.)

**For example:** When lit steadily, the Input 3 button indicates the following, depending on the switcher model:

- **Switchers with 12 input buttons** — 47 dB of attenuation when compared to the Input 3 button blinking quickly (48 dB to 50 dB of attenuation). The blinking Input 4 button (45 dB to 46 dB of attenuation) is at least 2 dB less than the fast blinking Input 3 button (48 dB – 46 dB) and at most 5 dB less (50 dB – 45 dB).
- **Switchers with 16 input buttons** — 52 dB of attenuation when compared to the Input 3 button blinking (53 dB to 55 dB of attenuation). The blinking Input 4 button (49 dB to 51 dB of attenuation) is at least 2 dB less than the fast blinking Input 3 button (53 dB – 51 dB) and at most and at most 6 dB less (55 dB – 49 dB).
- **Switchers with 32 input buttons** — 58 dB of attenuation when compared to the Input 3 button blinking (59 dB of attenuation). The blinking Input 4 button (57 dB of attenuation) is 2 dB less than the steadily-lit Input 2 button (59 dB - 57 dB).
- **On switchers with 32 input buttons**, the volume indications of the buttons are additive.

**For example:** Input 1 lit (23 dB [22 dB + 1 dB] of **attenuation reduction**), Input 2 lit (2 dB [1 dB + 1 dB] of **attenuation reduction**), and Input 3 blinking (1 dB of **attenuation reduction**) indicate that the output **attenuation has been reduced** by a total of 25 dB (22 dB + 2 dB + 1 dB = 25 dB).

- At full volume, no attenuation is applied to the output and all input buttons are lit steadily.

See **table 4** on the preceding page to read the volume display.

### Example 11: Viewing and adjusting an analog output volume level

In the following example, the audio output volume is viewed and adjusted. The steps show the front panel indications that result from your action.

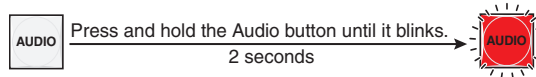
Audio output volume is displayed differently on different models (see [table 4](#) on page 70).

Because of the different volume display schemes, the output audio levels that result from the following example are shown three times:

- As displayed on a 32-input button switcher
- As displayed on a 16-input button switcher
- As displayed on a 12-input button switcher.

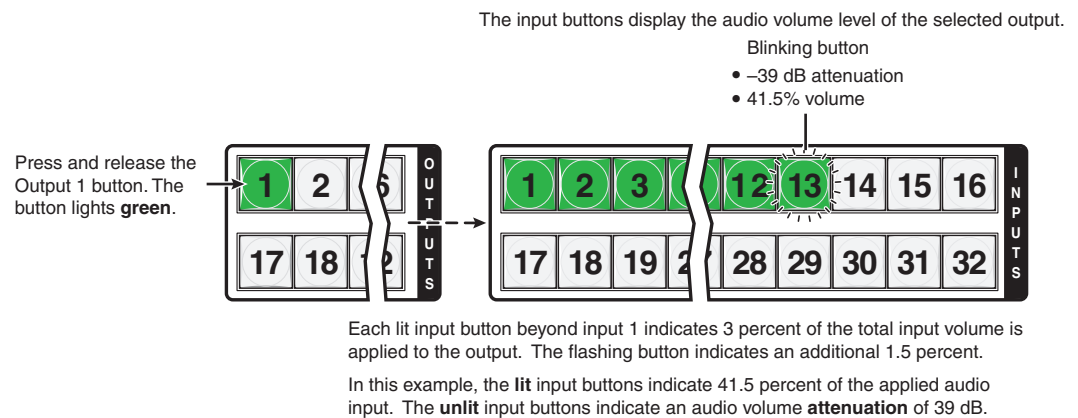
The 32-button displays show the actions that lead up to the display and the display itself. For simplicity, the 16-button and 12-button figures show the volume display only, not the actions that lead to it.

1. **Clear all selections:** Press and release the Esc button.
2. **Select Audio mode:** Press and **hold** the Audio button for approximately 2 seconds until it blinks.



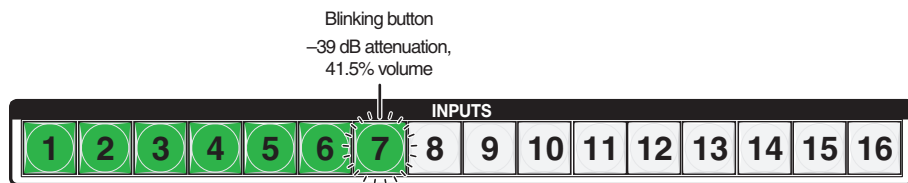
3. **Select an output:** Press and release the output 1 button (see figure 45).

In figure 45, figure 46, and figure 47, the lit or blinking input buttons indicate 41.5 percent of the applied audio input. The unlit input buttons indicate an audio volume attenuation of 39 dB.



**Figure 45. Select Output 1**

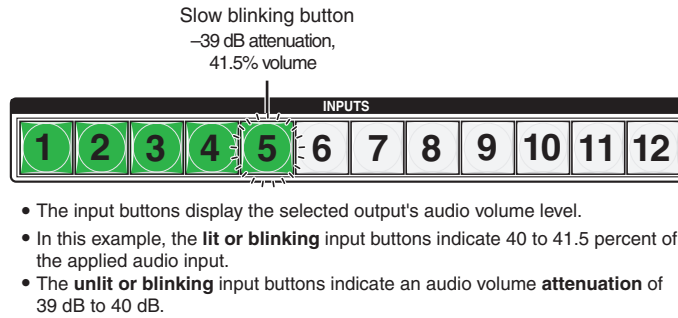
Figure 46 shows the same volume (41.5%) as figure 45, but displayed on a 16-input-button switcher, such as a MAV Plus 1616 HDA.



- The input LEDs display the selected output's audio volume level.
- In this example, the **lit or blinking** input buttons indicate 41.5 to 44.5 percent of the applied audio input.
- The **unlit or blinking** input buttons indicate an audio volume **attenuation** of 37 dB to 39 dB.

**Figure 46. Volume Display on a 12-input-button Switcher**

Figure 47 shows the same volume (41.5%) as in figure 45, but displayed on a 12-input-button switcher, such as a CrossPoint Ultra 128 HVA.



**Figure 47. Volume Display on a 12-input-button Switcher**

**NOTE:** Volume is protected when front panel *Lock* mode 2 is selected. You can view the volume in *Lock* mode 2 but you cannot change it from the front panel (see [Setting the Front Panel Locks \(Executive Modes\)](#) on page 75).

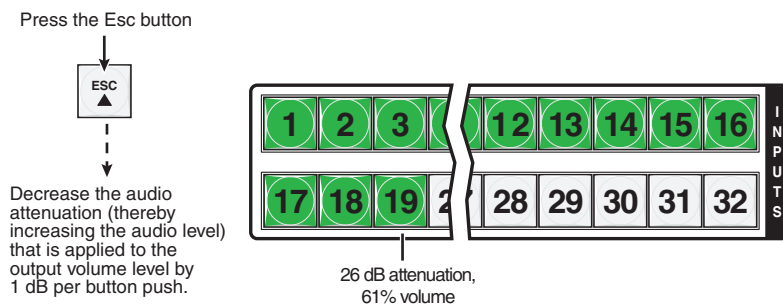
If front panel *Lock* mode 2 is selected and you try to perform step 4, the actions are ignored and the Enter, Video, and Audio buttons flash.

4. **Change the volume:** Press and release the Esc (▲) button once (see figure 48) to increase the volume by 1.5%.

Press and release the Esc (▲) button several more times (see figure 48) to increase the volume by 1.5% per button press. Note the input button indication changes that occur each time the Esc (▲) button is pressed and released.

**NOTE:** You can press and **hold** the Esc (▲) or View (▲) button to ramp the level up or down by 3 dB per second to the high or low limit.

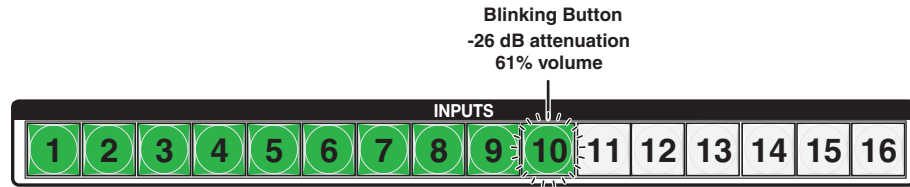
Figure 48 show the result of pressing the Esc (▲) button a total of 13 times. In figure 48, figure 49, and figure 50, the lit or blinking input buttons indicate 61 percent of the applied audio input. The unlit input buttons indicate an audio volume attenuation of 26 dB.



- The input buttons display the selected output's audio volume level.
- Each lit input button beyond input 1 indicates 3 percent of the total input volume is applied to the output.
- In this example, the **green** input buttons display 61 percent of the applied audio input.
- The **unlit** input buttons indicate an audio volume **attenuation** of 26 dB.

**Figure 48. Adjust the Output Audio Volume**

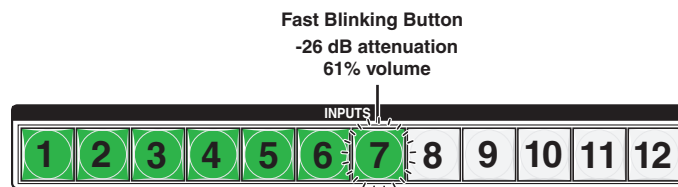
Figure 49 shows the same volume (61%) as in figure 48, but displayed on a 16-input-button switcher, such as a CrossPoint Ultra 168 HVA.



- The input LEDs display the selected output's audio volume level.
- In this example, the **lit/blinking** input buttons indicate 59.5 to 62.5 percent of the applied audio input.
- The **unlit/blinking** input buttons indicate an audio volume **attenuation** of 25 dB to 27 dB.

**Figure 49. Volume Display on a 16-input-button Switcher**

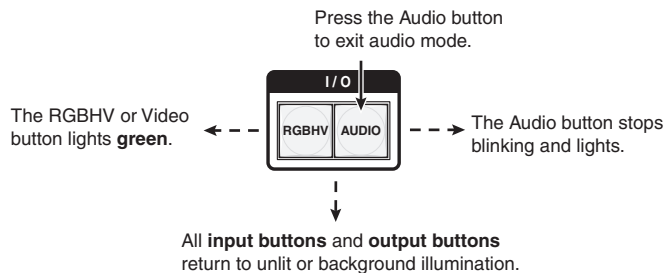
Figure 50 shows the same volume (61%) as in figure 48, but displayed on a 12-input-button switcher, such as a MAV Plus 128 RCA.



- The input LEDs display the selected output's audio volume level.
- In this example, the **lit/blinking** input buttons indicate 59.5 to 61 percent of the applied audio input.
- The **unlit/blinking** input buttons indicate an audio volume **attenuation** of 26 dB to 27 dB.

**Figure 50. Volume Display on a 12-input-button Switcher**

**5. Exit Audio mode:** Press and release the Audio button.





## Setting the Front Panel Locks (*Executive Modes*)

The matrix switchers have three levels of front panel security lock that limit the operation of the switcher from the front panel. The three levels are:

- **Lock mode 0** — The front panel is completely unlocked. All front panel functions are available.
- **Lock mode 1** — All changes are locked from the front panel (except for setting *Lock mode 2*). Some functions can be viewed.
- **Lock mode 2** — Basic functions are unlocked. Advanced features are locked and can be viewed only.

Basic functions consist of:

- Making ties
- Saving and recalling presets
- Setting input audio gain and attenuation
- Changing *Lock modes*

Advanced functions consist of:

- Creating I/O groups
- Setting RGB delay
- Setting audio output mutes
- Setting audio output volume
- Setting the rear panel remote port protocol and baud rate

**NOTE:** The switcher is shipped from the factory in *Lock mode 2*.

### Selecting *Lock mode 2* or toggling between mode 2 and mode 0

**NOTE:** If the switcher is in *Lock mode 0* or mode 1, this procedure selects mode 2. The Preset, View, and Esc buttons flash twice.

If the switcher is in *Lock mode 2*, this procedure selects mode 0 (unlocks the switcher). The View and Esc flash twice.

Toggle the lock on and off by pressing and holding the RGBHV (CrossPoint Ultra) or Video (MAV Plus) button and the Audio button for approximately 2 seconds (see figure 51).

Press and **hold** simultaneously to turn on *Lock mode 2* or to toggle between mode 2 and mode 0.



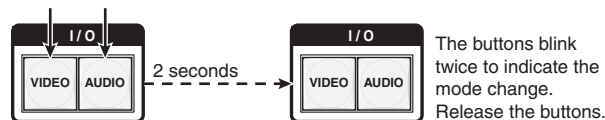
**Figure 51.** Toggle Front Panel *Lock* Between Mode 2 and Mode 0

## Selecting *Lock mode 2* or toggling between *mode 2* and *mode 1*

**NOTE:** If the switcher is in *Lock mode 0* or *mode 1*, this procedure selects *mode 2*.  
If the switcher is in *Lock mode 2*, this procedure selects *mode 1*.

Toggle the lock on and off by pressing and holding the RGBHV (CrossPoint Ultra) or Video (MAV Plus) button and the Audio button for approximately 2 seconds (see figure 52).

Press and **hold** the buttons simultaneously to turn on *Lock mode 2* or to toggle between *mode 1* and *mode 2*.



**Figure 52.** Toggle Front Panel *Lock* Between *Mode 2* and *Mode 1*

## Performing a System Reset from the Front Panel

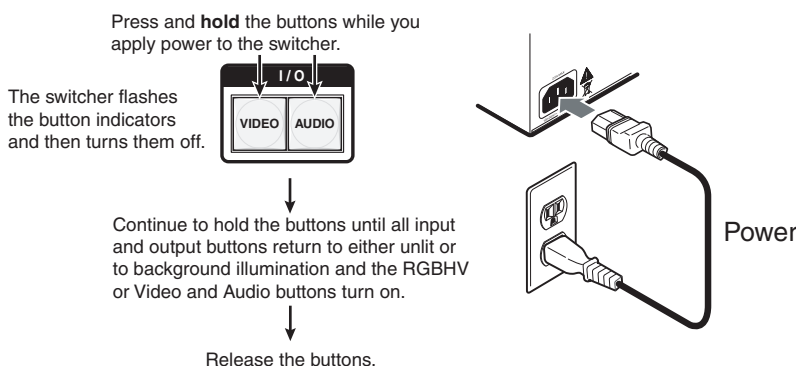
The front panel reset is identical to issuing the `[Esc]ZXXX←` SIS command defined on page 104. A system reset performs the following functions:

- Clears all ties and presets
- Clears all video and audio mutes
- Resets all I/O grouping
- Resets all RGB delay to 0 seconds
- Resets all input audio levels to unity gain (0 dB)
- Sets all output volume levels to 100% (0 dB of attenuation)

### NOTES:

- System reset does **not** reset the Internet protocol (IP) settings or replace user-installed firmware.
- The system reset clears most image and audio adjustments. To save these settings, use the Windows-based Matrix Switchers Control Program and the **File > Save MATRIX settings as...** selection (see page 124) before you perform this reset.
- If background illumination was turned on before the reset, the I/O and control buttons are unlit after the reset. But, when you cycle power, background illumination returns to as selected.

Reset the switcher to the factory default settings by pressing and **holding** the RGBHV (CrossPoint switchers) or Video (MAV Plus switchers) button and Audio button simultaneously **while** you apply AC power to the switcher (see figure 53).

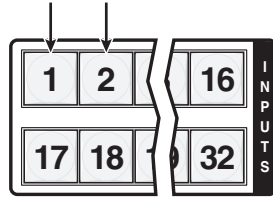


**Figure 53.** System Reset

## Background Illumination

The buttons on the front panel can be set to provide amber background illumination at all times or the background illumination can be turned off. To toggle the background illumination on or off, press and hold the Input 1 and Input 2 buttons simultaneously for approximately 2 seconds (see figure 54).

Press and **hold** the buttons simultaneously to toggle background illumination mode on or off.



After approximately 2 seconds, release the buttons.

**Figure 54.** Toggle Background Illumination on or off

## Selecting the Rear Panel Remote Port Protocol and Baud Rate

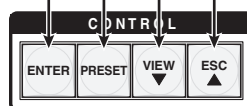
The rear panel Remote port on each switcher model can operate at the 9600, 19200, 38400, and 115200 baud rate and can support either RS-232 or RS-422 serial communication protocol. The settings of these variables can be viewed and changed from the front panel.

View and configure the serial communications settings as follows:

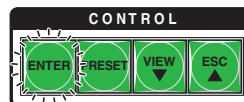
**NOTE:** The RS-232/RS-422 port settings are protected when front panel Lock mode 2 is selected. You can view the settings in Lock mode 2 but you cannot adjust them from the front panel. See [Setting the Front Panel Locks \(Executive Modes\)](#) on page 75.

1. **Select *Serial Port Selection and Configuration* mode:** Simultaneously press and hold all Control buttons (Enter, Preset, View, and Esc).

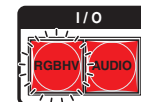
Press and **hold** the buttons.



2 seconds



- All Control buttons light with one flashing.



- Both I/O buttons light with one flashing.

The flashing Control button indicates the **baud rate** as follows:

Enter — 9600                      Preset — 19200  
View — 38400                      Esc — 115200

The flashing I/O button indicates the **protocol** as follows:

RGBHV or Video — RS-232      Audio — RS-422/RS-485

In this example, the port is set to RS-232 at 9600 baud.

2. Release the Control buttons.

**NOTE:** If front panel *Lock* mode 2 is selected and you try to perform step 3, the actions are ignored and the Enter, Video, and Audio buttons flash (see [Setting the Front Panel Locks \(Executive Modes\)](#) on page 75).

**3. Change a value:** Press and release the button that relates to the desired value.

Press and release the button(s) to configure the port as follows:

**Baud rate:**

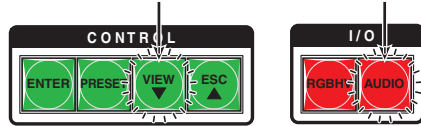
Enter — 9600                      Preset — 19200  
View — 38400                      Esc — 115200

**Serial protocol:**

RGBHV or Video — RS-232      Audio — RS-422/RS-485

The selected buttons blink and the others remain lit.

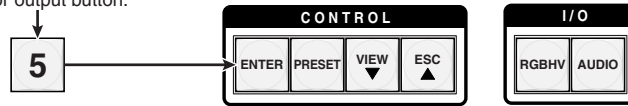
In this example, the port is set to RS-422 at 38400 baud.



**4. Exit the Serial Port Selection and Configuration mode:** Press and release an output button.

Press and release an input or output button.

All Control and I/O buttons return to unlit or background illumination.



## Rear Panel Reset Operations

The rear panel has a Reset button that initiates various levels of resets, dependant on the switcher model and defined in the table below:

Switcher model or MAV Plus switcher matrix size	Reset LED	Resets
All CrossPoint Ultra MAV Plus 88, 128, 816, 164, 168, 1212, 1616, 248, and 328	Yes	Comparable to IPL modes 3, 4, and 5 Hard reset (IPL mode 1)
All CrossPoint 450 Plus MAV Plus 2412, 2424, 3216, and 3232	No	Whole switcher reset Absolute reset Hard reset



For different reset levels, press and hold the button while the switcher is running or press and hold the button while you apply power to the switcher. The Reset button is recessed, so use an Extron Tweaker, a pointed stylus, or a ballpoint pen to access it.

See table 5 for a summary of the modes.

**ATTENTION:**

- Review the reset modes carefully. Using the wrong reset mode may result in unintended loss of flash memory programming, port reassignment, or a controller reboot.
- Étudier de près les différents modes de réinitialisation. Appliquer le mauvais mode de réinitialisation peut causer une perte inattendue de la programmation de la mémoire flash, une reconfiguration des ports ou une réinitialisation du contrôleur.

**NOTE:** The reset modes listed in table 5 close all open IP and Telnet connections and close all sockets. Also, the modes shown are separate functions, not a continuation from Mode 1 to Mode 5.

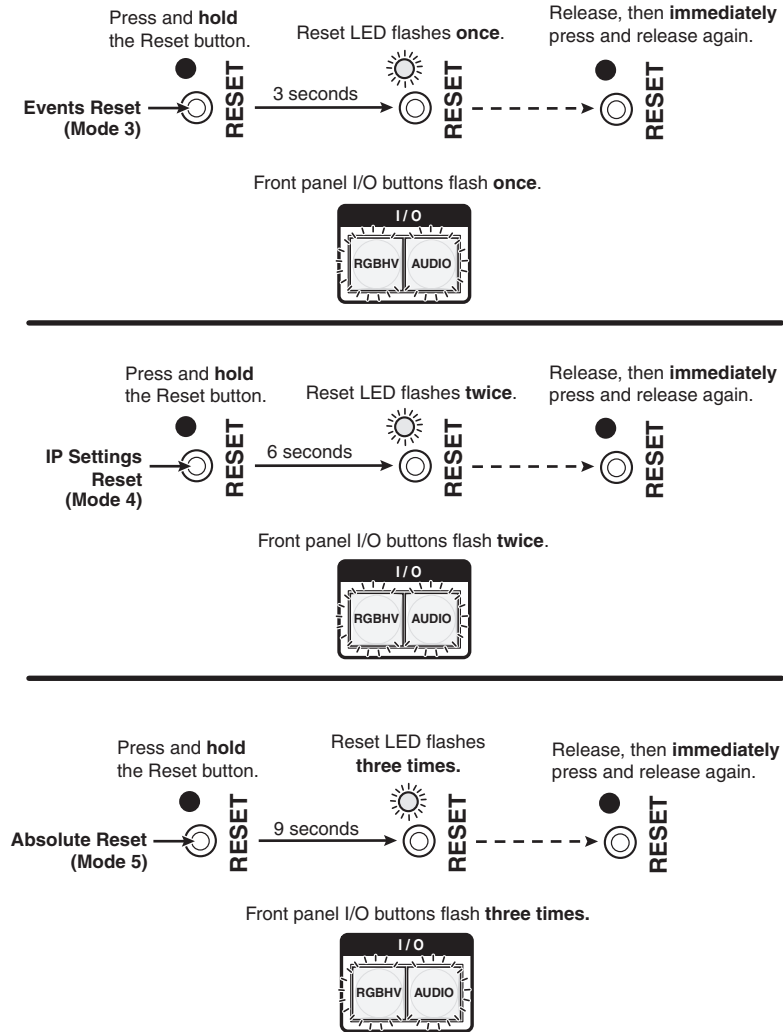
**Table 5. Reset Mode Comparison and Summary**

Mode	Activation	Result	Purpose and Notes
1	<p>Hold down the recessed Reset button while applying power to the switcher.</p> <p><b>NOTE:</b> After a mode 1 reset, update the switcher firmware to the latest version. Do not operate the switcher firmware version that results from the mode 1 reset. If you want to use the factory default firmware, you must upload that version again (see <a href="#">Updating the Firmware</a> on page 119 for details on uploading firmware).</p>	<p><b>The switcher reverts to the factory default firmware.</b> Event scripting will not start if the switcher is powered on in this mode. All user files and settings (such as drivers, adjustments, and IP settings) are maintained.</p> <p><b>NOTE:</b> If you do not want to update firmware, or you performed a mode 1 reset by mistake, cycle power to the switcher to return to the firmware version that was running before the mode 1 reset. Use the <code>00 SIS</code> command to confirm that the factory default firmware is no longer running (look for the asterisk [*] following the version number).</p>	Use mode 1 to revert to the factory default firmware version if incompatibility issues arise with user-loaded firmware.
3	Hold down the Reset button for about 3 seconds, until the Reset LED blinks once, then press and release Reset (<1 second) within 1 second.	<b>Mode 3 turns events on or off.</b> During resetting, the Reset LED flashes 2 times if events are starting, 3 times if events are stopping.	Mode 3 is useful for troubleshooting.
4	Hold down the Reset button for about 6 seconds, until the Reset LED blinks twice (once at 3 seconds and again at 6 seconds). Then press and release Reset (<1 second) within 1 second.	<p><b>Mode 4:</b></p> <ul style="list-style-type: none"> <li>• Enables ARP capability.</li> <li>• Sets the IP address to the factory default.</li> <li>• Sets the subnet address to the factory default.</li> <li>• Sets the gateway address to the factory default.</li> <li>• Sets port mapping to the factory default.</li> <li>• Turns DHCP off.</li> <li>• Turn events off.</li> </ul> <p>The Reset LED flashes four times in quick succession during the reset.</p>	Mode 4 enables you to set IP address information using ARP and the MAC address.
5	<p>Hold down the Reset button for about 9 seconds, until the Reset LED blinks three times (once at 3 seconds, again at 6 seconds, and then again at 9 seconds). Then press and release Reset (&lt;1 second) within 1 second.</p> <p><b>NOTE:</b> Mode 5 reset clears most adjustments. To save these settings, use the Matrix Switchers Control Program and the <b>File &gt; Save MATRIX settings as...</b> selection before you perform this reset (see page 124).</p>	<p><b>Mode 5 performs a complete reset to factory defaults (with the exception of the firmware):</b></p> <ul style="list-style-type: none"> <li>• Does everything mode 4 does.</li> <li>• Resets most real time adjustments, including: <ul style="list-style-type: none"> <li>clears all ties and presets,</li> <li>clears all mutes,</li> <li>clears all I/O grouping</li> <li>clears all RGB delay settings to zero</li> <li>clears all audio settings.</li> </ul> </li> <li>• Resets all IP options.</li> <li>• Removes/clears all files for the switcher.</li> </ul> <p>The reset LED flashes four times in quick succession during the reset.</p>	Mode 5 is useful if you want to start over with configuration and uploading or to replace events.

## Performing Soft System Resets (Resets 3, 4, and 5) – CrossPoint Ultra and MAV Plus 88, 128, 816, 164, 168, 1212, 1616, 248, and 328 Matrix Sizes

Perform a soft reset of the switcher as follows:

1. Use a small screwdriver to press and **hold** the rear panel Reset button until the Reset LED and the front panel Video and Audio buttons blink the number of times for the desired reset: once (events reset), twice (system reset), or three times (absolute reset) (see figure 55).



**Figure 55. Soft System Resets**

2. Release the Reset button and then immediately press and release the Reset button again. Nothing happens if the second momentary press does not occur within 1 second.

## Performing Soft Resets – CrossPoint 450 Plus and MAV Plus 2412, 2424, 3216, and 3232 Matrix Sizes

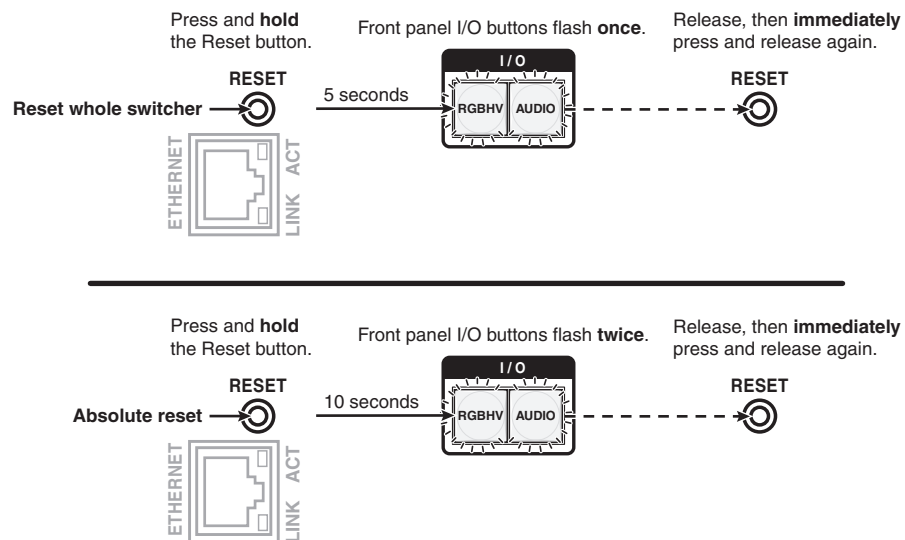
The whole switcher reset function is identical to the front panel system reset (see [Performing a System Reset from the Front Panel](#) on page 76) without requiring you to power down the switcher. This function is also identical to the [\[Esc\]ZXXX←](#) SIS command defined on page 104. System reset clears all ties and presets, resets all audio gains to unity gain (+0dB), and resets volume to 100% (0dB of attenuation).

**NOTE:** The whole switcher reset does not reset the Internet protocol (IP) settings or replace user-installed firmware.

The absolute reset function is identical to [\[Esc\]ZQQQ←](#) SIS command defined on page 104. Absolute reset performs all of the whole switcher reset functions and clears the IP address of the switcher to 192.168.254.254 and subnet mask to 255.255.0.0.

Perform soft resets as follows:

1. Use an Extron Tweezer or other small screwdriver to press and **hold** the Reset button until the front panel I/O buttons (RGBHV [CrossPoint switchers] or Video [MAV Plus switchers]) and Audio buttons blink once (reset whole switcher) or twice (absolute reset) (see figure 56).



**Figure 56. Whole Switcher and Absolute Resets**

2. Release the Reset button and then immediately press and release the Reset button again. Nothing happens if the second momentary press does not occur within 1 second.

## Performing a Hard Reset — All Models

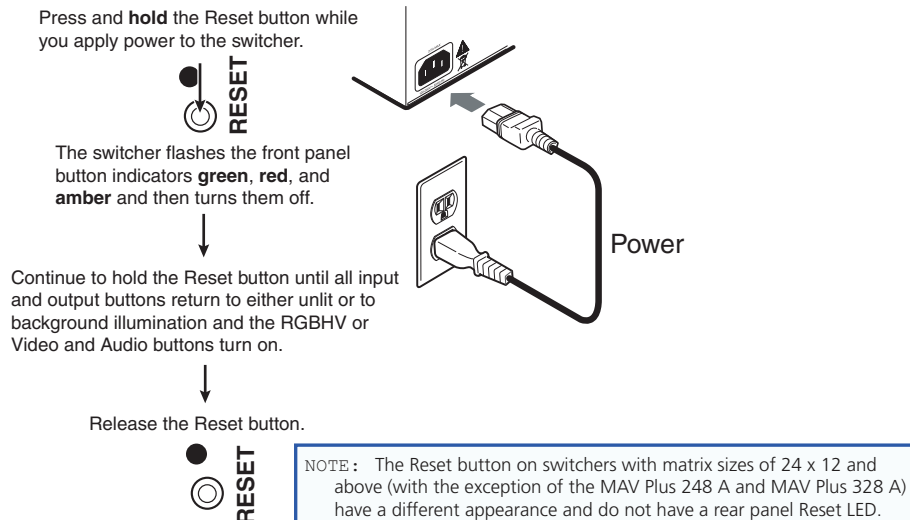
The hard reset function (mode 1 for the sake of comparison with an Extron IPL product) restores the switcher to the factory default firmware. Event scripting will not start if the switcher is powered on in this mode. All user files and settings (drivers, adjustments, IP settings, and the like) are maintained.

Perform a hard reset as follows:

### NOTES:

- After a hard reset is performed, update the switcher firmware to the latest version. Do not operate the switcher firmware version that results from the mode 1 reset. If you want to use the factory default firmware, you must upload that version again (see [Updating Firmware](#) on page 119).
- If you do not want to update firmware, or you performed a hard reset by mistake, cycle power to the switcher to return to the firmware version that was running before the mode 1 reset. Use the 0Q SIS command to confirm that the factory default firmware is no longer running (look for the asterisk [\*] following the version number).
- The hard reset restores the factory-installed firmware. The switcher reverts to that factory firmware the next time power is cycled off and on **unless** a firmware update is performed before the power cycle.
- Ensure that you have backed up any locally-created HTML, JavaScript, or other files that you have uploaded to the user file space of the switcher before you perform the hard reset. A hard reset will erase all locally-created files from the switcher.

1. If necessary, turn off power to the switcher.
2. Press and **hold** the Reset button on the rear panel **while** you apply AC power to the switcher (see figure 57).



**Figure 57. Hard Reset**



## Optimizing the Audio (Audio Models)

The level for each analog audio input can be adjusted within a range of -18 dB to +24 dB, so there are no noticeable volume differences between sources and for the best headroom and signal-to-noise ratio. The volume for each analog audio output can be adjusted from full loudness to effectively muted. Adjust the levels as follows:

1. Connect analog audio sources to all desired inputs and connect the analog audio outputs to output devices such as audio players (see **Audio input and output (audio models)** on page 24). For best results, wire all of the inputs and the outputs balanced.
2. Power on the audio sources, the switcher, and the audio players.
3. Switch among the inputs (see **Creating a Configuration** on page 42), listening to the audio with a critical ear or measuring the output audio level with test equipment, such as a VU meter.
4. As necessary, adjust the input audio level of each input (see **Viewing and Adjusting the Input Audio Level (Audio Models)** on page 63) so that the approximate output level is the same for all selected inputs.
5. Tie an audio input to each analog audio output.
6. As necessary, adjust the output audio level of each output (see **Viewing and Adjusting the Analog Output Volume (Audio Models)** on page 68).

## Troubleshooting

This section recommends what to do if you have problems operating the switcher and it describes an actual image problem that Extron has encountered.

1. Ensure that all devices are plugged in and powered on.
2. Check to see if one or more outputs are muted.
3. Ensure an active input is selected for output on the switcher.
4. Ensure that the proper signal format is supplied.
5. Check the cabling and make corrections as necessary.
6. Call the Extron S3 Sales and Technical Support Hotline if necessary. See **the end** of this guide for the phone number in your region of the world.

### Plasma Display S-video Problem (CrossPoint Switchers)

Extron has encountered a problem when a CrossPoint 450 Plus or CrossPoint Ultra switcher routes S-video that is output by some video conference codecs. Some codecs change the DC offset on the chrominance (C) so that it is very different from the level on the luminance (Y). This can cause a plasma display to come up in the wrong size mode.

With the matrix switcher taken out of the system, the plasma works fine. It looks like a problem with the matrix switcher, but it is not. The matrix switcher boosts the bad codec output, which makes the plasma go to the wrong setting.

**Solution:** Try placing an Extron video DC block adapter on the luminance (Y) input to the switcher from the codec.

# Configuration Worksheets

Rather than trying to remember the configuration for each preset, use worksheets to record this information. Make copies of the blank worksheet on [page 87](#) (32-input button and -output button switchers) and [page 88](#) (16-input button and 12-input button switchers) and use one for each preset configuration. The worksheets accommodate all of the CrossPoint and MAV Plus models. Cross out all unused or inactive inputs and outputs. Use different colors for video and audio.

**NOTE:** All of the equipment in the following examples is connected through the appropriate input board, output board, transmitter, or receiver.

## Worksheet Example 1: System Equipment

Figure 58 shows a worksheet for a CrossPoint 450 Plus 2424 HVA in a fictional organization with the system hardware annotated. Inputs 10, 11, and 21 through 24 have no connections in this organization, so they have been crossed out on the worksheet. A CrossPoint 450 Plus 2424 does not have inputs 25 through 32, so they are crossed out. Similarly, outputs 7, 14, 15, 16, and 25 through 32 are crossed out.

Input sources															
Camera main podium	Camera #2	Podium Mic	Laptop RGB 201 Rxi	Audio CD	Classroom #1 VCR (DVS 406)	Classroom #2 VCR (DVS 406)	PCI RGB 201 Rxi	Rack DVD (DVS)	X	X	VTG 400	Floorbox #1	Floorbox #2	Floorbox #3	Floorbox #4
1	2	3	4	5	6	7	8	9	10	11	12	13	14	15	16
17	18	19	20	21	22	23	24	25	26	27	28	29	30	31	32
Demo rack #1 USP 405	Demo rack #2 USP 405	Demo rack #3 USP 405	Demo rack #4 USP 405	X	X	X	X	X	X	X	X	X	X	X	X

Output destinations															
Main Hall PJ#1	Main Hall PJ#2	Podium monitor	Conf. room	Sound system #2	VCR (USP 405)	X	Lobby monitor	Class room #1 monitor	Class room #2 monitor	Demo room PJ #1	Demo rack monitor	Demo rack switcher	X	X	X
1	2	3	4	5	6	7	8	9	10	11	12	13	14	15	16
17	18	19	20	21	22	23	24	25	26	27	28	29	30	31	32
Demo wallbox #1	Demo wallbox #2	Demo wallbox #3	Demo wallbox #4	Demo wallbox #5	Demo wallbox #6	Demo wallbox #7	Demo wallbox #8	X	X	X	X	X	X	X	X

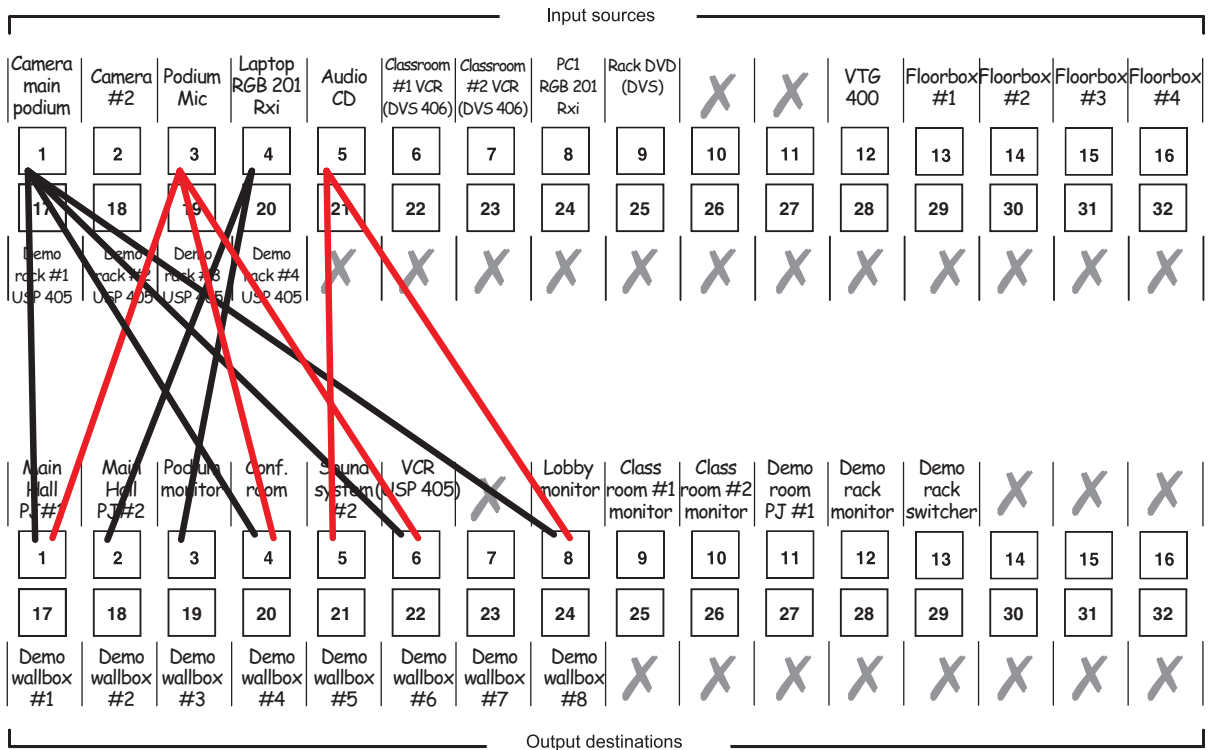
Preset # 1 Title: Worksheet Example Video: — Audio: —  
 Fill in the preset number, use colors or dashes, etc. to make connecting lines.  
 Indicate if the configuration is for Video, Audio, or both.

**Figure 58. Worksheet Example 1: System Equipment**

Inputs include PCs, an audio CD player, cameras, and an Extron VTG 400. Output devices include monitors, front and rear projectors, a stereo, and a VCR for recording presentations. The Extron VTG 400 video test generator connected to input 12 enables a video test pattern to be sent to one, several, or all output devices for problem isolation or adjustment purposes. An audio test tape or CD could be used in a similar manner to check out the audio components.

## Worksheet Example 2: Daily Configuration

Figure 59 continues from worksheet example 1 by showing the video and audio ties that make up the configuration of preset 1. Solid black lines shows video ties and red lines show the audio ties.



Preset # 1 Title: Worksheet Example Video: — Audio: —  
 Fill in the preset number, use colors or dashes, etc. to make connecting lines.  
 Indicate if the configuration is for Video, Audio, or both.

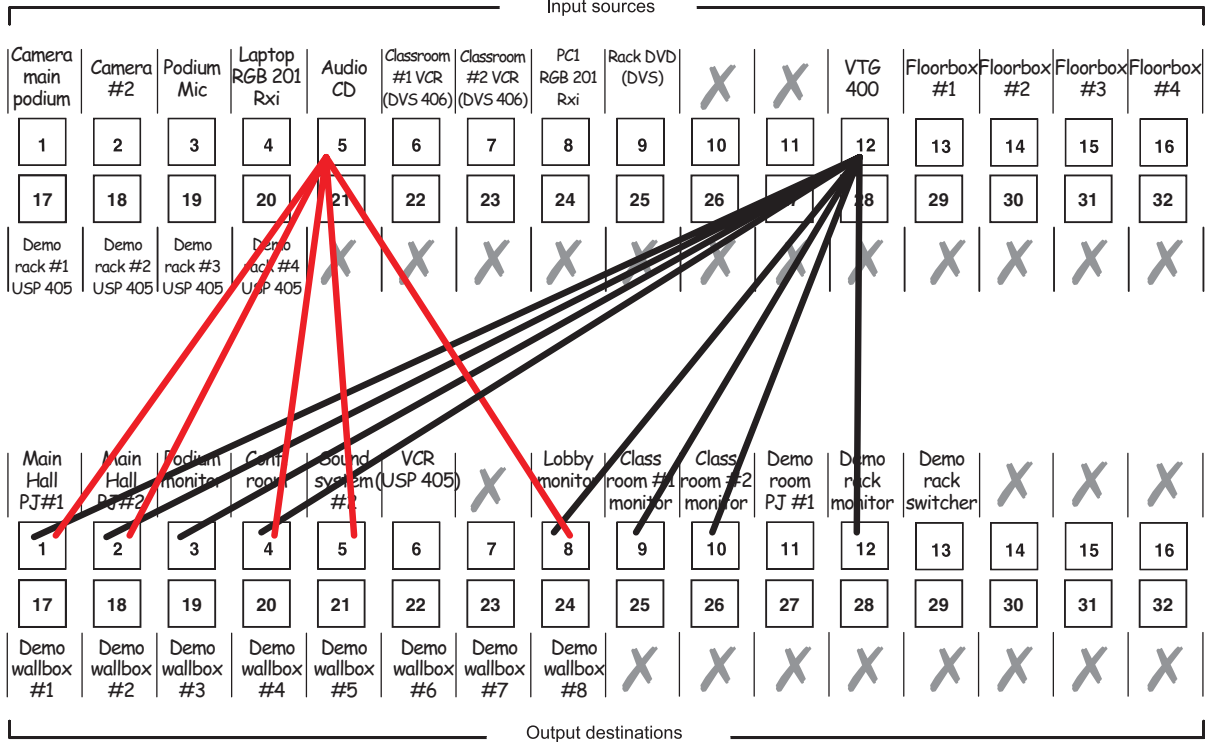
**Figure 59. Worksheet example 2: Daily Configuration**

In this example:

- The image of the presenter, from the main podium camera (input 1), is:
  - Displayed in the main hall (output 1)
  - Displayed in the conference room (output 4) to the overflow crowd
  - Displayed in the lobby (output 8)
  - Tied to the VCR (output 6)
- The presenter has a presentation on her laptop computer (input 4) that is:
  - Displayed in the main hall (output 2)
  - Displayed locally on the podium (output 3)
- The audio from the microphone of the presenter (input 3) is:
  - Played in the hall (output 1)
  - Played in the conference room (output 4)
  - Sent to the VCR (output 6)
- Classical music from the CD player (input 5) is:
  - Played in the background in the main hall on sound system #2 (output 5)
  - Played in the lobby (output 8)

### Worksheet Example 3: Test Configuration

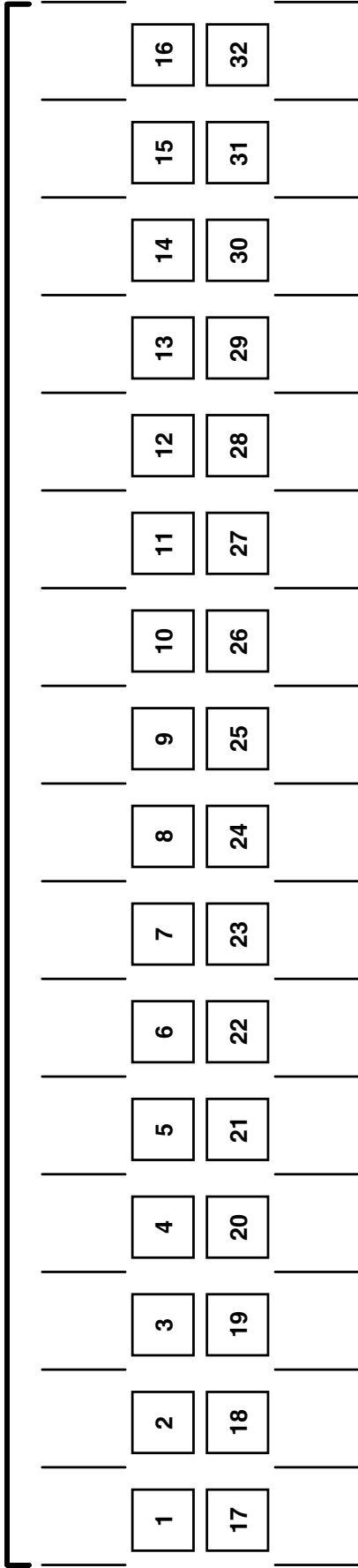
The A/V system in our fictional organization needs to be fine tuned on a regular basis. Figure 60 shows a typical test configuration, with an Extron video test generator (input 12) generating a test pattern to all monitors (outputs 1, 2, 3, 4, and 8, 9, 10, and 12). Sound checks are run from the CD player (input 5) to all audio systems (outputs 1, 2, 4, 5, and 8).



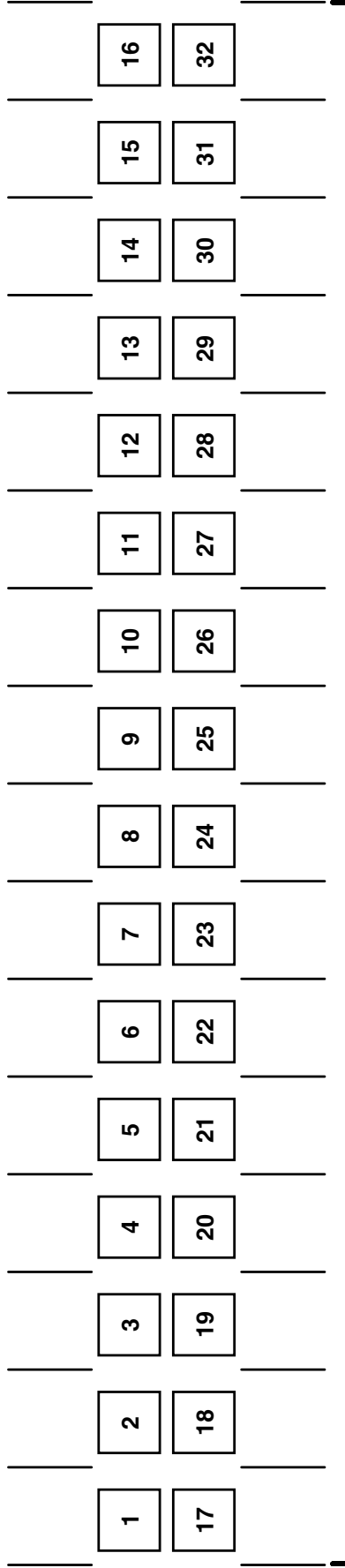
Preset # 32 Title: Worksheet Example Video: — Audio: —  
 Fill in the preset number, use colors or dashes, etc. to make connecting lines.  
 Indicate if the configuration is for Video, Audio, or both.

**Figure 60. Worksheet Example 3: Test Configuration**

Input sources



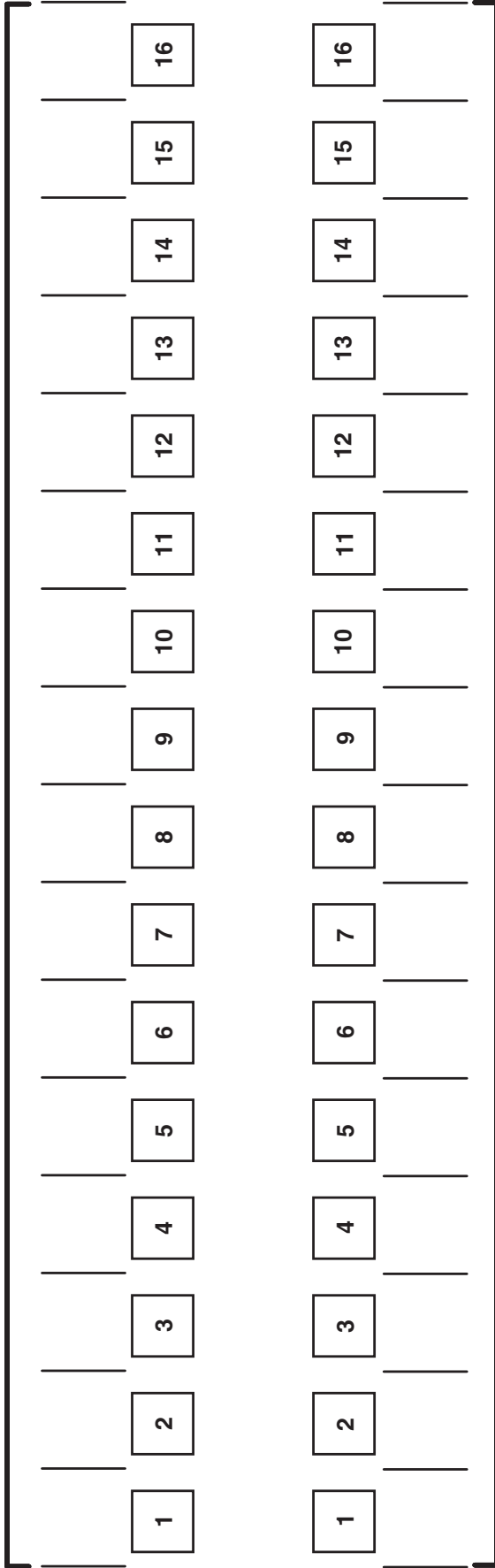
Output destinations



Preset # \_\_\_\_\_ Title: \_\_\_\_\_ Video: \_\_\_\_\_ Audio: \_\_\_\_\_  
 Fill in the preset number and use colors, or dashes, etc. to make connecting lines.  
 Indicate if the configuration is for Video, Audio, or both.

**32-button switchers configuration worksheet**

Input sources



Output destinations

Preset # \_\_\_\_\_ Title: \_\_\_\_\_ Video: \_\_\_\_\_ Audio: \_\_\_\_\_  
Fill in the preset number and use colors, or dashes, etc. to make connecting lines.  
Indicate if the configuration is for video, audio, or both.

### 16-button switchers configuration worksheet

# Programming Guide

The CrossPoint and MAV Plus matrix switchers can be remotely controlled via:

- The Matrix Switchers Control Program (see the [Matrix Software](#), beginning on page 110)
- Built-in HTML pages (see [HTML Operation](#), beginning on page 131)
- SIS commands (see below)

This section describes the operation of the CrossPoint and MAV Plus matrix switchers via SIS commands, including:

- [Serial Ports](#)
- [Ethernet \(LAN\) Port](#)
- [Host-to-Switcher Instructions](#)
- [Switcher-Initiated Messages](#)
- [Switcher Error Responses](#)
- [Using the Command and Response Tables](#)
- [Command and Response Table for SIS Commands](#)
- [SIS Command and Response Table for IP- and Remote Port-Specific Commands](#)
- [Special Characters](#)

## Serial Ports

The switchers have two serial ports that can be connected to a host device such as a computer running the HyperTerminal utility, an RS-232 capable PDA, or a control system. These ports make serial control of the switcher possible. The serial ports are:

- The rear panel Remote (RS-232 or RS-422) port, a 9-pin D female connector
- The front panel Configuration (RS-232) port, a 2.5 mm mini stereo jack

The default protocol for both ports is as follows:

- 9600 baud
- no parity
- 8-bit
- 1 stop bit
- no flow control

The ports can be configured to operate at the 9600, 19200, 38400, or 115200 baud rate.

### NOTES:

- These ports are independent of one another. A front panel Configuration port connection and a rear panel Remote RS-232/RS-422 port connection can be active at the same time.
- Extron recommends leaving both ports at 9600 baud only.

## Rear Panel RS-232/RS-422 Port

The rear panel RS-232/RS-422 port can support either RS-232 or RS-422 serial communication protocol. See [Selecting the Rear Panel Remote Port Protocol and Baud Rate](#) on page 77 to configure the rear panel Remote port baud rate and protocol from the front panel.

## Front Panel Configuration Port

This port is hardwired for RS-232 only.

The optional 9-pin D to 2.5 mm mini jack TRS RS-232 cable can be used for connection to the Configuration port.

**NOTE:** This port is independent of the rear panel Remote RS-232/RS-422 port and is not affected by changes to the protocol of the rear panel port. The protocol of this front panel port can be changed via SIS command control only. See the [Set serial ports parameters](#) command on page 109, to configure **either** port under SIS control.

## Ethernet (LAN) Port

The rear panel Ethernet connector on the switcher can be connected to an Ethernet LAN or WAN. Communication between the switcher and the controlling device is via Telnet (a TCP socket using port 23). The Telnet port can be changed, if necessary, via SIS. This connection makes SIS control of the switcher possible using a computer connected to the same LAN or WAN. The SIS commands and behavior of the product are identical to the commands and behavior the product exhibits when you are communicating with it via a serial port.

The Ethernet cable can be terminated as a straight-through cable or a crossover cable and must be properly terminated for your application (see [item 9](#) on page 27).

- **Crossover cable** — Direct connection between the computer and the CrossPoint or MAV Plus switcher.
- **Patch (straight-through) cable** — Connection of the CrossPoint or MAV Plus switcher to an Ethernet LAN.



## Default IP addresses

To access the CrossPoint or MAV Plus switcher via the LAN port, you need the IP address for the unit, and may need the subnet mask and the gateway address. If the IP address has been changed to an address comprised of words and characters, you can determine the actual numeric IP address using the ping (ICMP) utility (see [Ethernet Link](#) on page 149 for more details). If the addresses have not been changed, the factory-specified defaults are:

- **IP address** 192.168.254.254
- **Subnet mask** 255.255.0.0
- **Gateway address** 0.0.0.0

## Establishing a Connection

Establish a network connection to CrossPoint or MAV Plus switcher as follows:

1. Open a TCP socket to port 23 using the IP address of the switcher.

**NOTE:** If the local system administrators have not changed the value, the factory-specified default, 192.168.254.254, is the correct value for this field.

The switcher responds with a copyright message including the date, the name of the product, firmware version, part number, and the current date/time.

### NOTES:

- If the switcher is **not** password-protected, the device is ready to accept SIS commands immediately after it sends the copyright message.
- If the switcher **is** password-protected, a **password** prompt appears below the copyright message.

2. If the switcher is password protected, enter the appropriate administrator or user password.

If the password is accepted, the switcher responds with **Login User** or **Login Administrator**.

If the password is not accepted, the **Password** prompt reappears.

## Connection Timeouts

The Ethernet link times out after a designated period of time of no communications. By default, this timeout value is set to five minutes but the value can be changed. See the [Configure port timeout](#) SIS commands on page 109.

**NOTE:** Extron recommends leaving the default timeout at 5 minutes and periodically issuing the Query (Q) command to keep the connection active. If there are long idle periods, Extron recommends disconnecting the socket and reopening the connection when another command must be sent.

## Number of Connections

A CrossPoint or MAV Plus switcher can have up to 200 simultaneous TCP connections, including all http sockets and telnet connections. When the connection limit is reached, the switcher accepts no new connections until some have been closed. No error message or indication is given that the connection limit has been reached. To maximize performance of an IP Link device, the number of connections should stay low and unnecessary open sockets should be closed.

## Using Verbose Mode

Telnet connections to an CrossPoint or MAV Plus switcher can be used to monitor for changes that occur on the switcher, such as front panel operations and SIS commands from other telnet sockets or a serial port. For a telnet session to receive change notices from the switcher, the telnet session must be in verbose mode 1 or 3. See the **Verbose Mode** SIS command on page 109. In verbose mode 3, the telnet socket reports changes in messages that resemble SIS command responses.

## Host-to-Switcher Instructions

The switcher accepts SIS (Simple Instruction Set) commands through the rear panel Remote RS-232 / RS-422 port, the front panel Configuration port, and the rear panel Ethernet (LAN) Port. SIS commands consist of one or more characters per command field. They do not require any special characters to begin or end the command character sequence. Each switcher response to an SIS command ends with a carriage return and a line feed (CR/LF = **↵**), which signals the end of the response character string. A string is one or more characters.

## Switcher-initiated Messages

When a local event such as a front panel operation occurs, the switcher responds by sending a message to the host. The switcher-initiated messages are listed below (underlined).

The switcher does not expect a response from the host, but, for example, the host program might request a new status.

(c) Copyright 20yy, Extron Electronics CP 300 450 MAV IP, Vx.xx,  
60-nnnn-01 {day,date,time}↵

— or —

(c) Copyright 20yy, Extron Electronics CP Ultra IP, Vx.xx,  
60-nnnn-01 {day,date,time}↵

The switcher initiates the **Copyright** message when it is first powered on or when a connection via Internet protocol (IP) is established. *Vx.xx* is the firmware version number and *60-nnnn-01* is the switcher part number.

**NOTE:** *{day,date,time}* are reported only if the connection is via the LAN port.

Password:↵

The switcher initiates the **Password** message immediately after the copyright message when the controlling system is connected using TCP/IP or Telnet and the switcher is password protected. This message means that the switcher requires an administrator or user level password before it will perform the commands entered via this link. The switcher repeats the password message response for every entry other than a valid password until a valid password is entered.

↵Login Administrator↵

↵Login User↵

The switcher initiates the **Login** message when a correct administrator or user password has been entered. If the user and administrator passwords are the same, the switcher defaults to administrator privileges.

Qik↵

The switcher initiates the **Qik** message when a front panel tie creation has occurred.

#### Sprnn←

The switcher initiates the **Spr** message when a memory preset has been saved from the front panel. “*nn*” is the preset number.

#### Rprnn←

The switcher initiates the **Rpr** message when a memory preset has been recalled from the front panel. “*nn*” is the preset number.

#### Innn•Audxx←

The switcher initiates the **Aud** message when a front panel input audio level change has occurred. “*n*” is the input number and “*xx*” is the dB level.

#### Outnn•Volxx←

The switcher initiates the **Vol** message when a front panel output audio volume change has occurred. *nn* is the output number and *xx* is the volume level.

#### Vmtnn\*x←

The switcher initiates the **Vmt** message when an output video mute is toggled on or off from the front panel. *nn* is the output number and *x* is the mute status: 1 = on, 0 = off.

#### Amtnn\*x←

The switcher initiates the **Amt** message when an output audio mute is toggled on or off from the front panel. *nn* is the output number and *x* is the mute status: 1 = on, 0 = off.

#### Exen←

The switcher initiates the **Exe** message when the front panel security lockout (executive mode) is toggled on or off from the front panel. “*n*” is the executive mode: 0, 1, or 2.

## Switcher Error Responses

When the switcher receives an SIS command and determines that it is valid, it performs the command and sends a response to the host device. If the switcher is unable to perform the command because the command is invalid or contains invalid parameters, the switcher returns an error response to the host. The error response codes are:

**E01** — Invalid input channel number (out of range)

**E10** — Invalid command

**E11** — Invalid preset number (out of range)

**E12** — Invalid output number (out of range)

**E13** — Invalid value (out of range)

**E14** — Invalid command for this configuration

**E17** — Timeout (caused only by direct write of global presets)

**E22** — Busy

**E24** — Privileges violation (Users have access to all view and read commands [other than the administrator password], and can create ties, presets, and audio mutes)

**E25** — Device not present

**E26** — Maximum number of connections exceeded

**E27** — Invalid event number

**E28** — Bad filename / file not found

## Using the Command and Response Tables

The command and response tables begin on the [next page](#). Command and response examples are shown throughout the tables. With the exception of the audio input gain and attenuation commands, the SIS commands are **not** case sensitive. The ASCII to HEX conversion table below is for use with the command and response table.

	ASCII to Hex Conversion Table																Esc	1B	CR	0D	LF	0A
Space →	20	!	21	"	22	#	23	\$	24	%	25	&	26	'	27							
	(	28	)	29	*	2A	+	2B	,	2C	-	2D	.	2E	/	2F						
	0	30	1	31	2	32	3	33	4	34	5	35	6	36	7	37						
	8	38	9	39	:	3A	;	3B	<	3C	=	3D	>	3E	?	3F						
	@	40	A	41	B	42	C	43	D	44	E	45	F	46	G	47						
	H	48	I	49	J	4A	K	4B	L	4C	M	4D	N	4E	O	4F						
	P	50	Q	51	R	52	S	53	T	54	U	55	V	56	W	57						
	X	58	Y	59	Z	5A	[	5B	\	5C	]	5D	^	5E	_	5F						
	,	60	a	61	b	62	c	63	d	64	e	65	f	66	g	67						
	h	68	i	69	j	6A	k	6B	l	6C	m	6D	n	6E	o	6F						
	p	70	q	71	r	72	s	73	t	74	u	75	v	76	w	77						
	x	78	y	79	z	7A	{	7B		7C	}	7D	~	7E	DEL	7F						

## Command and Response Table for SIS Commands

### Symbol Definitions

Symbols, defined below, are used in the tables to represent variables in the command and response fields.

↵ = Carriage return/line feed

← = Carriage return (no line feed)

| = Pipe (can be used interchangeably with the ← character)

• = space

**Esc** = Escape key

**W** = Can be used interchangeably with the **Esc** character

**X1** = Input number (for tie)

**00** – (maximum number of inputs for your model) (**00** = untied)

**X2** = Output number

**01** – (maximum number of outputs for your model)

**NOTE:** Input and output numbers in commands may be entered as either 1-digit or 2-digit numbers. All input and output numbers are reported as 2-digit numbers in the response.

**X3** = Mute, Lock mode, power supply

**0** = off/mode 0/not OK

**1** = on/mode 1/OK

**2** = mode 2

**X4** = Input number (for other than ties)

**01** – (maximum number of inputs for your model)

**X5** = Audio gain

**0** – 24 (1 dB/step)

**X6** = Numeric dB value

–18 to +24 (45 steps of gain or attenuation) (default = 0 dB)

**X7** = Audio attenuation

**1** – 18 (1 dB/step)

**X8** = Volume adjustment range

**0** – 64 (1 dB/step except for 0-to-1, which is 22 dB) (default = 64 [0 dB])

(see [table 6](#) on page 97)

**X9** = Global or room preset #

**00** - 32, 10 maximum for a room preset (00 = current configuration for view only)

**NOTE:** A *Room preset* is a stored configuration with all of the outputs assigned to a single room. When a room preset is retrieved from memory, it becomes the current configuration.

**X10** = Room # (for room presets)

**10** max. (Each can have up to 10 presets (**X9**s) assigned.)

**NOTE:** A *Room* is a subset of operator-selected outputs that relate to each other. The CrossPoint or MAV Plus switchers support up to 10 rooms, each of which can consist of from 1 to 16 outputs.

**X11** = Name

12 characters maximum,

Upper- and lower-case alphanumeric characters and \_ / and spaces are valid.

**NOTE:** The following characters are invalid or not recommended in the name: <space> ~ , @ = ' [ ] { } < > ' " ; : \ and ?.

<b>X12</b> = Video/audio mute:	0 = no mutes	2 = audio mute
	1 = video mute	3 = video and audio mute
<b>X13</b> = Sync frequency	xxx.xx (frequency in Hz [V] or kHz [H])	
<b>X14</b> = Connection status	0 = no input connected	1 = input connected
<b>X15</b> = RGB delay interval	Delay in 1/2 second increments (10 maximum)	
<b>X16</b> = Group # (for I/O grouping)	1 through 4 groups (0 = no group)	
<b>X17</b> = Inputs	Total number of inputs for this switcher	
<b>X18</b> = Outputs	Total number of outputs for this switcher	
<b>X19</b> = Part number	60-nnn-nn	
<b>X20</b> = Firmware version number to second decimal place (x.xx)		
<b>X21</b> = Verbose firmware version-description-upload date/time.	See the Query controller firmware version (verbose) command on <a href="#">page 105</a> .	
<b>X22</b> = Voltage	Positive or negative voltage and magnitude	
<b>X23</b> = Temperature	Degrees Fahrenheit	
<b>X24</b> = Fan speed	RPM	

## Command and Response Table for SIS Commands

Command Function	SIS Command (Host to Unit)	Response (Unit to Host)	Additional description
<b>Create Ties</b>			
<b>NOTES:</b>			
<ul style="list-style-type: none"> <li>• Commands can be entered back-to-back in a string, with no spaces. For example: 1*1!02*02&amp;03*03\$4*8\$.</li> <li>• The quick multiple tie and tie input to all output commands activate all I/O switches simultaneously.</li> <li>• The &amp; tie command for RGB and the % tie command for video can be used interchangeably on the matrix switchers.</li> </ul>			
Tie input video and audio to output	X1*X2!	OutX2•InX1•A11←	Tie the input X1 video and audio to output X2.
<i>Example:</i>	1*3!	Out03•In01•A11←	Tie input 1 video and audio to output 3.
Tie input video (RGB) only to output	X1*X2&	OutX2•InX1•RGB←	Audio breakaway.
<i>Example (see last Note bullet, above):</i>	10*4&	Out04•In10•RGB←	Tie input 10 RGB to output 4.
Tie input video only to output	X1*X2%	OutX2•InX1•Vid←	Audio breakaway.
<i>Example (see last Note bullet, above):</i>	7*5%	Out05•In07•Vid←	Tie input 7 video to output 5.
Tie input audio only to output	X1*X2\$	OutX2•InX1•Aud←	Audio breakaway.
<i>Example:</i>	24*4\$	Out04•In24•Aud←	Tie input 24 audio to output 4.
Quick multiple tie	Esc+QX1*X2!...X1*X2\$←	Qik←	
<i>Example:</i>	Esc+Q3*4!3*5%3*6\$←	Qik←	Tie input 3 video and audio to output 4, tie input 3 video to output 5, and tie input 3 audio to output 6.
Tie input to all outputs, video and audio	X1*!	InX1•A11←	
<i>Example:</i>	5*!	In05•A11←	Tie input 5 video and audio to all outputs.
Clear all ties	0*!	In00•A11←	
Tie input to all outputs, RGB (video) only	X1*&	InX1•RGB←	Audio breakaway.
<i>Example (see last Note bullet, above):</i>	8*&	In08•RGB←	Tie input 8 RGB to all outputs.
Tie input to all outputs, video only	X1*%	InX1•Vid←	Audio breakaway.
<i>Example (see last Note bullet, above):</i>	10*%	In10•Vid←	Tie input 10 video to all outputs.
Tie input to all outputs, audio only	X1*\$	InX1•Aud←	Audio breakaway.
<b>NOTE:</b> X1 = Input number (for tie)      00 – 16 or 32 (00 = untied)			
X2 = Output number      01 – 16 or 32			

## Command and Response Table for SIS Commands (continued)

Command Function	SIS Command (Host to Unit)	Response (Unit to Host)	Additional description
<b>Read ties</b>			
<b>NOTE:</b> The <b>&amp; read tie</b> command for RGB and the <b>% read tie</b> command for video can be used interchangeably on the matrix switchers.			
Read RGB (video) output tie	$\boxed{x2}\&$	$\boxed{x1}\leftarrow$	RGB input $\boxed{x1}$ is tied to output $\boxed{x2}$ .
Read video output tie	$\boxed{x2}\%$	$\boxed{x1}\leftarrow$	Video input $\boxed{x1}$ is tied to output $\boxed{x2}$ .
Read audio output tie	$\boxed{x2}\$$	$\boxed{x1}\leftarrow$	Audio input $\boxed{x1}$ is tied to output $\boxed{x2}$ .
<b>Video mutes</b>			
RGB or video mute	$\boxed{x2}*1\text{B}$	$\text{Vmt}\boxed{x2}*1\leftarrow$	Mute output $\boxed{x2}$ video (video off).
RGB or video unmute	$\boxed{x2}*\emptyset\text{B}$	$\text{Vmt}\boxed{x2}*\emptyset\leftarrow$	Unmute output $\boxed{x2}$ video (video on).
Read RGB or video mute	$\boxed{x2}\text{B}$	$\boxed{x3}\leftarrow$	$\boxed{x3} = 1 = \text{enable (muted)}$ $\emptyset = \text{disable (unmuted) (default)}$ .
Global RGB or video mute	$1*\text{B}$	$\text{Vmt}1\leftarrow$	Mute all video outputs.
Global RGB or video unmute	$\emptyset*\text{B}$	$\text{Vmt}\emptyset\leftarrow$	Unmute all video outputs.
<b>Audio input gain and attenuation</b>			
<b>NOTE:</b> The set gain (G) and set attenuation (g) commands <b>are</b> case sensitive.			
Set audio input gain to +dB value <i>Example:</i>	$\boxed{x4}*\boxed{x5}\text{G}$ $1*2\text{G}$	$\text{In}\boxed{x4}*\text{Aud}\boxed{x6}\leftarrow$ $\text{In}\emptyset1*\text{Aud}+\emptyset2\leftarrow$	Set input 1 audio gain to +2 dB.
Set audio input attenuation to -dB value	$\boxed{x4}*\boxed{x7}\text{g}$	$\text{In}\boxed{x4}*\text{Aud}\boxed{x6}\leftarrow$	
Increment gain <i>Example:</i>	$\boxed{x4}+\text{G}$ $5+\text{G}$	$\text{In}\boxed{x4}*\text{Aud}\boxed{x6}\leftarrow$ $\text{In}\emptyset5*\text{Aud}+\emptyset3\leftarrow$	Increase gain by 1 dB. Increase audio input 5 level from +2 dB to +3 dB.
Decrement gain <i>Example:</i>	$\boxed{x4}-\text{G}$ $7-\text{G}$	$\text{In}\boxed{x4}*\text{Aud}\boxed{x6}\leftarrow$ $\text{In}\emptyset7*\text{Aud}-\emptyset9\leftarrow$	Decrease gain by 1 dB. Decrease audio input 7 level from -8 dB to -9 dB.
Read input gain <i>Example:</i>	$\boxed{x4}\text{G}$ $3\text{G}$	$\boxed{x6}\leftarrow$ $-\emptyset6\leftarrow$	Audio input 3 level is at -6 dB.
<b>NOTE:</b>			
$\boxed{x1}$ = Input number (for tie)	$\emptyset\emptyset$ – (maximum number of inputs for your model) ( $\emptyset\emptyset$ = untied)		
$\boxed{x2}$ = Output number	$\emptyset1$ – (maximum number of outputs for your model)		
$\boxed{x3}$ = Mute status	$\emptyset$ = off (unmuted) $1$ = on (muted)		
$\boxed{x4}$ = Input number (for other than tie)	$\emptyset1$ – (maximum number of inputs for your model)		
$\boxed{x5}$ = Audio gain	$\emptyset$ – 24 (1 dB per step)		
$\boxed{x6}$ = Numeric dB value	-18 to +24 (45 steps of gain or attenuation) (Default = 0 dB)		
$\boxed{x7}$ = Audio attenuation	$1$ – 18 (1 dB per step)		

## Command and Response Table for SIS Commands (continued)

Command Function	SIS Command (Host to Unit)	Response (Unit to Host)	Additional description
<b>Audio output volume</b>			
<b>NOTE:</b> Table 11, below, the commands defines the value of each audio volume step.			
Set a specific audio volume <i>Example:</i>	$\text{X2}*\text{X8}\text{V}$ 1*50v	Out $\text{X2}$ •Vol $\text{X8}$ ← Out01•Vol150←	Volume setting for output 7 is 50 (79%).
Increment volume <i>Example:</i>	$\text{X2}+\text{V}$ 1+v	Out $\text{X2}$ •Vol $\text{X8}$ ← Out01•Vol151←	Increase volume by 1 step.
Decrement volume	$\text{X2}-\text{V}$	Out $\text{X2}$ •Vol $\text{X8}$ ←	Decrease volume by 1 step.
Read output volume	$\text{X2}\text{V}$	$\text{X8}$ ←	

**Table 6. Audio Volume Adjustment Settings**

$\text{X8}$ value	dB of attenuation	Output volume	$\text{X8}$ value	dB of attenuation	Output volume	$\text{X8}$ value	dB of attenuation	Output volume
00	76	0%						
01	63	5.5%	23	41	38.5%	45	19	71.5%
02	62	7%	24	40	40%	46	18	73%
03	61	8.5%	25	39	41.5%	47	17	74.5%
04	60	10%	26	38	43%	48	16	76%
05	59	11.5%	27	37	44.5%	49	15	77.5%
06	58	13%	28	36	46%	50	14	79%
07	57	14.5%	29	35	47.5%	51	13	80.5%
08	56	16%	30	34	49%	52	12	82%
09	55	17.5%	31	33	50.5%	53	11	83.5%
10	54	19%	32	32	52%	54	10	85%
11	53	20.5%	33	31	53.5%	55	9	86.5%
12	52	22%	34	30	55%	56	8	88%
13	51	23.5%	35	29	56.5%	57	7	89.5%
14	50	25%	36	28	58%	58	6	91%
15	49	26.5%	37	27	59.5%	59	5	92.5%
16	48	28%	38	26	61%	60	4	94%
17	47	29.5%	39	25	62.5%	61	3	95.5%
18	46	31%	40	24	64%	62	2	97%
19	45	32.5%	41	23	65.5%	63	1	98.5%
20	44	34%	42	22	67%	64	0	100%
21	43	35.5%	43	21	68.5%			
22	42	37%	44	20	70%			

**NOTE:**  $\text{X2}$  = Output number  
 $\text{X8}$  = Volume

01 – 16 or 32  
00 – 64 (1 dB per step except for 0-to-1, which is 13 dB). See table 11, above.

## Command and Response Table for SIS Commands (continued)

Command Function	SIS Command (Host to Unit)	Response (Unit to Host)	Additional description
<b>Audio mutes</b>			
Mute audio	$\overline{x2} * 1 Z$	$Amt\overline{x2} * 1 \leftarrow$	Mute output $\overline{x2}$ audio (audio off).
Unmute audio	$\overline{x2} * 0 Z$	$Amt\overline{x2} * 0 \leftarrow$	Unmute output $\overline{x2}$ audio (audio on).
View audio mute status	$\overline{x2} Z$	$\overline{x3} \leftarrow$	
Global audio mute	$1 * Z$	$Amt 1 \leftarrow$	Mute all audio outputs.
Global audio unmute	$0 * Z$	$Amt 0 \leftarrow$	Unmute all audio outputs.
<b>Save, recall, and directly write global and room presets</b>			
<b>NOTES:</b>			
<ul style="list-style-type: none"> <li>If you try to recall a preset that is not saved, the matrix switcher responds with the error code E11.</li> <li>If the room is nonexistent, the matrix switcher responds with the error code E21.</li> <li>The following characters are invalid or not recommended in preset names: + - , ` @ = [ ] { } ‘ “ ; :   \ and ?.</li> </ul>			
Save current configuration as a global preset	$\overline{x9} ,$	$Spr\overline{x9} \leftarrow$	Command character is a comma.
<i>Example:</i>	$9 ,$	$Spr09 \leftarrow$	Save current ties as preset 9.
Recall a global preset	$\overline{x9} .$	$Rpr\overline{x9} \leftarrow$	Command character is a period.
<i>Example:</i>	$5 .$	$Rpr05 \leftarrow$	Recall preset 5, which becomes the current configuration.
Write room outputs	$\overline{Esc}\overline{x10} , \overline{x2}^1 , \overline{x2}^2 , \dots \overline{x2}^n MR \leftarrow$	$Mpr\overline{x10} , \overline{x2}^1 , \overline{x2}^2 , \dots \overline{x2}^n \leftarrow$	See notes.
<b>NOTES:</b>			
<ul style="list-style-type: none"> <li>A room can contain a maximum of 16 outputs.</li> <li>An output can belong to only one room.</li> <li>The maximum number of rooms (<math>\overline{x10}</math>) is 10.</li> <li>If no room name is assigned, the default name (<math>\overline{x11}</math>) is "Room #<math>\overline{x10}</math>.....".</li> </ul>			
<i>Example:</i>	$\overline{Esc}8 , 3 , 04 , 5 , 6 MR \leftarrow$	$Mpr8 , 03 , 04 , 05 , 06 \leftarrow$	Outputs 3, 4, 5, and 6 are assigned to room 8.
Read room outputs	$\overline{Esc}\overline{x10} MR \leftarrow$	$\overline{x11} , \overline{x2}^1 , \overline{x2}^2 , \dots \overline{x2}^n \leftarrow$	
<i>Example:</i>	$\overline{Esc}3 MR \leftarrow$	$Room \# 03 \dots , 01 , 02 , 08 , 09 \leftarrow$	Outputs 1, 2, 8, and 9 are assigned to room 3, which is named "Room #03".
Save current configuration as a room preset	$\overline{x10} * \overline{x9} ,$	$Rmm\overline{x10} * Spr\overline{x9} \leftarrow$	Command character is a comma.
<i>Example:</i>	$3 * 9 ,$	$Rmm03 * Spr09 \leftarrow$	Save current ties as preset 9 for room 3.
Recall room preset	$\overline{x10} * \overline{x9} .$	$Rmm\overline{x10} * Rpr\overline{x9} \leftarrow$	Command character is a period.
<b>NOTE:</b>			
$\overline{x2}$ = Output number	$01$ – (maximum number of outputs for your model)		
$\overline{x3}$ = Mute status	$0$ = off (unmuted) $1$ = on (muted)		
$\overline{x9}$ = Global or room preset number	$00 - 32, 10$ maximum for a room preset ( $00$ = current configuration for view only)		
$\overline{x10}$ = Room number (for room presets)	$10$ max. (Each can have up to 10 presets ( $\overline{x9}$ s) assigned.)		
$\overline{x11}$ = Name	12 characters (upper- and lower-case alphanumeric characters and / and spaces) max.		



## Command and Response Table for SIS Commands (continued)

Command Function	SIS Command (Host to Unit)	Response (Unit to Host)	Additional description
<b>Direct write process —</b>			
<p><b>NOTE:</b> The direct write of a global preset should always be preceded by a clear global preset ties command of that same preset number. In a directly-written preset, the input for each output position (or no tied input) remains unchanged unless overwritten or cleared.</p> <p>If you do not <b>clear</b> the ties in a global preset number <b>before</b> you directly <b>write</b> a global preset to that number, ties that are part of the previous version of the specified preset with the same number can unexpectedly become part of the newly-created preset.</p>			
Clear global preset ties	<code>[Esc]+[X9]P0*!←</code>	<code>Spr[X9]←</code>	Clear all ties in preset [X9].
Directly write a global preset	<code>[Esc]+[X9]P[X1]*[X2]! [X1]*[X2] %[X1]*[X2]\$ ... [X1]*[X2]&amp;←</code>	<code>Spr[X9]←</code>	Enter as many ties as are valid. The <b>tie all</b> (!), <b>tie RGB</b> (&), <b>tie video</b> (%), and <b>tie audio</b> (\$) commands are all valid.
<i>Example:</i>	<code>[Esc]+27P0*!←</code> <code>[Esc]+27P12*5! 10*09%3*2\$3*8&amp;←</code>	<code>Spr27←</code> <code>Spr27←</code>	Clear all ties in preset 27. Brackets are shown to separate ties for clarity only. Create global preset 27, which ties video and audio input 12 to output 5, video input 10 to output 9, audio input 3 to output 2, and video input 3 to output 8.
Directly write a room preset	<code>[Esc]+[X10]*[X9]P[X1]*[X2]! [X1]*[X2] %[X1]*[X2]\$ ... [X1]*[X2]&amp;←</code>	<code>Rmm[X10]•Spr[X9]←</code>	Enter as many ties as are valid for this model. <b>Tie all</b> (!), <b>tie RGBHV</b> (&), <b>tie video</b> (%), and <b>tie audio</b> (\$) commands are all valid.
<i>Example:</i>	<code>[Esc]+7*3P12*7&amp; 11*5\$4*5%6*6!←</code>	<code>Rmm07•Spr03←</code>	Brackets are shown to separate ties for clarity only. Create preset 3 for room 7, which ties input 12 to output 7, input 11 to output 5, input 4 to output 5, and input 6 to output 6.
<b>View ties, gain, volume, mutes, and presets</b>			
View video and audio output tie	<code>[X2]!</code>	<code>[X1]←</code>	
<i>Example:</i>	<code>15!</code>	<code>27←</code>	Input 27 video and audio are tied to output 15.
View RGBHV output tie	<code>[X2]&amp;</code>	<code>[X1]←</code>	
<i>Example:</i>	<code>7&amp;</code>	<code>02←</code>	Input 2 RGB is tied to output 7.
View video output tie	<code>[X2]%</code>	<code>[X1]←</code>	
<i>Example:</i>	<code>3%</code>	<code>06←</code>	Input 6 video is tied to output 3.
View input gain or attenuation	<code>[X4]G</code>	<code>[X6]←</code>	
<i>Example:</i>	<code>4G</code>	<code>-02←</code>	Gain for input 4 is -2 dB.
View output volume	<code>[X2]V</code>	<code>[X8]←</code>	
<i>Example:</i>	<code>7V</code>	<code>55←</code>	Volume for output 7 is 55 steps (9 dB of attenuation, 86.5% of total volume).
<p><b>NOTE:</b></p> <ul style="list-style-type: none"> <li>[X1] = Input number (for tie)</li> <li>[X2] = Output number</li> <li>[X4] = Input number (for other than tie)</li> <li>[X6] = Numeric dB value</li> <li>[X8] = Volume</li> <li>[X9] = Global or room preset number</li> <li>[X10] = Room number (for room presets)</li> <li>00 – (maximum number of inputs for your model) (00 = untied)</li> <li>01 – (maximum number of outputs for your model)</li> <li>01 – (maximum number of inputs for your model)</li> <li>-18 to +24 (45 steps of gain or attenuation) (Default = 0 dB)</li> <li>00 – 64 (1 dB per step except for 0-to-1, which is 13 dB) (see table 6, on page 97)</li> <li>00 - 32, 10 maximum for a room preset (00 = current configuration for view only)</li> <li>10 max. (Each can have up to 10 presets [X9s] assigned.)</li> </ul>			

## Command and Response Table for SIS Commands (continued)

Command Function	SIS Command (Host to Unit)	Response (Unit to Host)	Additional description
<b>View ties, gain, volume, mutes, and presets (continued)</b>			
View output mutes	<code>EscVM←</code>	<code>X12<sup>n</sup>X12<sup>2</sup>...X12<sup>n</sup>←</code>	Each <code>X12</code> response is the mute status of an output, starting from output 1. <i>n</i> = the maximum number of outputs.
<i>Example:</i> CrossPoint 450 Plus 3232 HVA	<code>EscVM←</code>	Mut00001000000230000000000000000000←	Output 5 video, output 12 audio, and output 13 video and audio are muted. All other outputs are unmuted.
<b>NOTE:</b> The “Mut” portion of the response appears only when the switcher is in Verbose mode 2 or 3. See the Verbose mode command on <a href="#">page 109</a> .			
View video global preset configuration	<code>EscX9*X2*1VC←</code>	<code>X1<sup>n</sup>•X1<sup>n+1</sup>•...•X1<sup>n+15</sup>•Vid←</code>	Show preset <code>X9</code> video configuration. Show the input ( <code>X1</code> ) tied to 16 sequential outputs, starting from output <code>X2</code> .
<i>Command description:</i>	preset #*starting output # (StO#)*1(=video)VC		
<i>Response description:</i>	input # (#) tied to StO#•# tied to StO#+1•# tied to StO#+2• ... •# tied to StO#+15•Vid←		
<b>NOTES:</b>			
<ul style="list-style-type: none"> <li>The starting output number (<code>X2</code>) should always be “1” for matrix sizes of 16 outputs or smaller.</li> <li><code>EscX9*X2*1VC←</code> where <code>X9</code> = 0 returns the current video configuration of the switcher.</li> </ul>			
<i>Example:</i> MAV Plus 3232	<code>Esc4*17*1VC←</code>	<p>input 24 tied to output 19      no tied input      input 8 tied to output 29</p> <p>Response = tied input: 08•08•24•08•08•29•29•00•08•01•01•01•08•08•08•08•Vid←</p> <p>Output: 17 18 19 20 21 22 23 24 25 26 27 28 29 30 31 32</p>	<p>Each position shown in the response is an output: left = starting output (17), right = starting output +15 (32). The number in each position is the input tied to that output.</p> <p>In this example, preset 4, video input 1 is tied to outputs 26 through 28; input 8 is tied to outputs 17, 18, 20, 21, 25, and 29 through 32; input 24 is tied to output 19; and input 29 is tied to outputs 22 and 23. No input is tied to output 24.</p>
View audio global preset configuration	<code>EscX9*X2*2VC←</code>	<code>X1<sup>n</sup>•X1<sup>n+1</sup>•...•X1<sup>n+15</sup>•Aud←</code>	Show preset <code>X9</code> audio configuration. Show the input ( <code>X1</code> ) tied to 16 sequential outputs, starting from output <code>X2</code> .
<i>Command description:</i>	preset #*starting output # (StO#)*2(=audio)VC		
<i>Response description:</i>	input # (#) tied to StO#•# tied to StO#+1•# tied to StO#+2• ... •# tied to StO#+15•Aud←		
<b>NOTES:</b>			
<ul style="list-style-type: none"> <li>The starting output number (<code>X2</code>) should always be “1” for matrix sizes of 16 outputs or smaller.</li> <li><code>EscX9*X2*2VC←</code> where <code>X9</code> = 0 returns the current audio configuration of the switcher.</li> </ul>			
<i>Example:</i> MAV Plus 2412	<code>Esc15*1*2VC←</code>	<p>input 1 tied to output 3      no tied input      no outputs</p> <p>Response = tied input: 01•01•01•01•02•22•22•00•03•03•03•03•...•...•Aud←</p> <p>Output: 01 02 03 04 05 06 07 08 09 10 11 12 13 14 15 16</p>	<p>Each position shown in the response is an output: left = starting output (1), right = starting output +15 (16). The number in each position is the input tied to that output. (Outputs 13 through 16 are not present on the MAV Plus 2412.)</p> <p>In this example, preset 15, audio input 1 is tied to outputs 1 through 4; input 2 is tied to output 5; input 3 is tied to outputs 9 through 12; and input 22 is tied to outputs 6 and 7. No input is tied to output 8. Outputs 13 through 16 are not present on this switcher.</p>
<b>NOTE:</b>			
<code>X1</code> = Input number (for tie)	<code>00</code> – (maximum number of inputs for your model) ( <code>00</code> = untied)	<code>01</code> – (maximum number of outputs for your model)	
<code>X2</code> = Output number	<code>01</code> – (maximum number of outputs for your model)	<code>00 - 32</code> ( <code>00</code> = current configuration for view only)	
<code>X9</code> = Global or room preset number	<code>0</code> = no mutes <code>1</code> = video mute <code>2</code> = audio mute <code>3</code> = video and audio mute		
<code>X12</code> = Video/audio mute:			

## Command and Response Table for SIS Commands (continued)

Command Function	SIS Command (Host to Unit)	Response (Unit to Host)	Additional description
<b>View ties, gain, volume, mutes, and presets (continued)</b>			
View video room preset configuration	<code>Esc</code> <code>X10</code> * <code>X9</code> * <code>X2</code> *1VC ←	<code>X1</code> <sup>n</sup> • <code>X1</code> <sup>n+1</sup> •...• <code>X1</code> <sup>n+15</sup> •Vid ←	Show room <code>X10</code> , preset <code>X9</code> video configuration. Show the input ( <code>X1</code> ) tied to 16 sequential outputs assigned to room <code>X10</code> , starting from output <code>X2</code> .
<i>Command description:</i>	room #*room preset #*starting output # (StO#)*1(=video)VC		
<i>Response description:</i>	input # (I#) tied to StO#•I# tied to StO#+1• ... •I# tied to StO#+15•Vid ←		
<b>NOTE:</b> The starting output number ( <code>X2</code> ) should always be "1" for matrix sizes of 16 outputs or smaller.			
View audio room preset configuration	<code>Esc</code> <code>X10</code> * <code>X9</code> * <code>X2</code> *2VC ←	<code>X1</code> <sup>n</sup> • <code>X1</code> <sup>n+1</sup> •...• <code>X1</code> <sup>n+15</sup> •Aud ←	Show room <code>X10</code> , preset <code>X9</code> audio configuration. Show the input ( <code>X1</code> ) tied to 16 sequential outputs assigned to room <code>X10</code> , starting from output <code>X2</code> .
<i>Command description:</i>	room #*room preset #*starting output # (StO#)*2(=audio)VC		
<i>Response description:</i>	input # (I#) tied to StO#•I# tied to StO#+1• ... •I# tied to StO#+15•Aud ←		
<b>NOTE:</b> The starting output number ( <code>X2</code> ) should always be "1" for matrix sizes of 16 outputs or smaller.			
<b>Digital Sync Validation Processing (DSVP) (CrossPoint Switchers)</b>			
List individual sync frequency	<code>X4</code> Ls	<code>X13</code> , <code>X13</code> ←	Listed as horizontal frequency, vertical frequency.
<i>Example:</i>	2LS	031.50 , 060.00 ←	Input 2 horizontal frequency is 31.5 kHz and its vertical frequency is 60 Hz.
<b>NOTE:</b> The matrix switcher returns 000.00,000.00 if there is no connection or sync frequencies are not applicable.			
View connections	0LS	<code>X14</code> <sup>1</sup> <code>X14</code> <sup>2</sup> <code>X14</code> <sup>3</sup> ... <code>X14</code> <sup>n</sup> ←	Each <code>X14</code> response is the connection status (0 = no input detected, 1 = input detected) of an input, starting from input 1. n is the maximum number of inputs for this model.
<b>RGB delay (CrossPoint) Switchers</b>			
Set RGB delay	<code>Esc</code> <code>X2</code> * <code>X15</code> D ←	Out <code>X2</code> •Dly <code>X15</code> ←	Set the RGB interval for ties to output 13 to 3.5 seconds (7 x 0.5 sec.).
<i>Example:</i>	<code>Esc</code> 13*7D ←	Out13•Dly07 ←	
View RGB delay	<code>Esc</code> <code>X2</code> D ←	<code>X15</code> ←	Output 14 interval is 2.5 seconds (5 x 0.5 sec.).
<i>Example:</i>	<code>Esc</code> 14D ←	05 ←	
<b>NOTE:</b>			
<code>X1</code> = Input number (for tie)	<code>X2</code> = Output number	<code>X4</code> = Input number (for other than tie)	<code>X9</code> = Global or room preset number
<code>X10</code> = Room number (for room presets)	<code>X13</code> = Sync frequency	<code>X14</code> = Connection status	<code>X15</code> = RGB delay interval
<code>00</code> – (maximum number of inputs for your model) ( <code>00</code> = untied)	<code>01</code> – (maximum number of outputs for your model)	<code>01</code> – (maximum number of inputs for your model)	<code>00</code> - 32, 10 maximum for a room preset ( <code>00</code> = current configuration for view only)
		10 max. (Each can have up to 10 presets ( <code>X9</code> s) assigned.)	100 max. (Each can have up to 10 presets ( <code>X9</code> s) assigned.)
	xxx.xx (frequency in Hz [V] or kHz [H])	0 = no input connected      1 = input connected	Delay in 1/2 second increments (10 maximum)

## Command and Response Table for SIS Commands (continued)

Command Function	SIS Command (Host to Unit)	Response (Unit to Host)	Additional description
<b>I/O Grouping</b>			
<b>NOTE:</b> The group that is assigned in each of the following I/O grouping commands ( $\overline{\text{X16}}$ ) must be 1, 2, 3, 4, or 0 (not grouped).			
Write input grouping	$\overline{\text{Esc}}\overline{\text{X16}}\overline{\text{X16}}^2\dots\overline{\text{X16}}^n\text{I}\leftarrow$	$\text{Gri}\overline{\text{X16}}\overline{\text{X16}}^2\overline{\text{X16}}^3\dots\overline{\text{X16}}^n\leftarrow$	Each $\overline{\text{X16}}$ entry is the group number assigned to an input position, starting from input 1. $n$ = the maximum number of inputs for this model.
<i>Example: CrossPoint 450 Plus 3232</i>	$\overline{\text{Esc}}40\dots33\text{I}\leftarrow$	See below.	
	Input 1 in group 4    Input 2 not grouped		Input 32 in group 3
	Response #s = group: Gri 4 0 1 3 3 0 0 0 0 4 4 4 4 1 1 2 2 1 2 2 3 3 3 3 2 1 2 2 3 3 3 3		Input 1 - group 4, input 2 - group 0 (ungrouped), ... input 31 - group 3, input 32 - group 3.
	Input: 01 02 03 04 05 06 07 08 09 10 11 12 13 14 15 16 17 18 19 20 21 22 23 24 25 26 27 28 29 30 31 32		
Write output grouping	$\overline{\text{Esc}}\overline{\text{X16}}\overline{\text{X16}}^2\dots\overline{\text{X16}}^n\text{O}\leftarrow$	$\text{Gro}\overline{\text{X16}}\overline{\text{X16}}^2\overline{\text{X16}}^3\dots\overline{\text{X16}}^n\leftarrow$	Each $\overline{\text{X16}}$ entry is the group number assigned to an output position, starting from output 1. $n$ = the maximum number of outputs for this model.
Read input grouping	$\overline{\text{Esc}}\text{I}\leftarrow$	$\overline{\text{X16}}\overline{\text{X16}}^2\overline{\text{X16}}^3\dots\overline{\text{X16}}^n\leftarrow$	Each $\overline{\text{X16}}$ entry is the group number assigned to an input position, starting from input 1. $n$ = the maximum number of inputs for this model.
<i>Example: MAV Plus 2424</i>	$\overline{\text{Esc}}\text{I}\leftarrow$	See below.	
	Input 1 in group 1    Input 9 not grouped		Input 24 in group 3
	Response = group: 1 1 1 3 3 0 0 0 0 4 4 4 4 1 1 2 2 1 2 2 3 3 3 3		
	Input: 01 02 03 04 05 06 07 08 09 10 11 12 13 14 15 16 17 18 19 20 21 22 23 24		
Read output grouping	$\overline{\text{Esc}}\text{O}\leftarrow$	$\overline{\text{X16}}\overline{\text{X16}}^2\overline{\text{X16}}^3\dots\overline{\text{X16}}^n\leftarrow$	Each $\overline{\text{X16}}$ entry is the group number assigned to an output position, starting from output 1. $n$ = the maximum number of outputs for this model.
<b>NOTE:</b> $\overline{\text{X16}}$ = Group number (for I/O grouping) 1 through 4 groups (0 = no group)			

## Command and Response Table for SIS Commands (continued)

Command Function	SIS Command (Host to Unit)	Response (Unit to Host)	Additional description
<b>Names</b>			
<b>NOTE:</b> The HTML language reserves certain characters for specific functions (see <a href="#">Special Characters</a> on page 109).			
Write global preset name	<code>EscX9, X11NG ←</code>	<code>NmgX9, X11 ←</code>	
<i>Example:</i>	<code>Esc1, Security 1NG ←</code>	<code>Nmg01, Security 1 ←</code>	Name global preset 1 "Security 1".
Read global preset name	<code>EscX9NG ←</code>	<code>X11 ←</code>	
<i>Example:</i>	<code>Esc2NG ←</code>	<code>Security 2 ←</code>	
Write room preset name	<code>EscX10*X9, X11NP ←</code>	<code>NmpX10*X9, X11 ←</code>	
<i>Example:</i>	<code>Esc1*3, Podium_DVDNP ←</code>	<code>Nmp01*3, Podium_DVD ←</code>	Name room 1, preset 3 "Podium_DVD".
Read room preset name	<code>EscX10*X9NP ←</code>	<code>X11 ←</code>	
<b>NOTES:</b>			
<ul style="list-style-type: none"> <li>Do not use leading spaces in preset names.</li> <li>If a preset is unassigned, the <code>X11</code> displays [unassigned].</li> <li>If a global preset is saved, but not yet named, the default name is Preset <code>X9</code>.</li> <li>If a room preset is saved, but not yet named, the default name is Rm <code>X10</code> Prst <code>X9</code>.</li> </ul>			
Write input name	<code>EscX4, X11NI ←</code>	<code>NmiX4, X11 ←</code>	
<i>Example:</i>	<code>Esc1, Podium camNI ←</code>	<code>Nmi01, Podium cam ←</code>	Name input 1 "Podium cam".
Read input name	<code>EscX4NI ←</code>	<code>X11 ←</code>	
Write output name	<code>EscX2, X11NO ←</code>	<code>NmoX2, X11 ←</code>	
<i>Example:</i>	<code>Esc1, Main PJ1NO ←</code>	<code>Nmo01, Main PJ1 ←</code>	Name output 1 "Main PJ1".
Read output name	<code>EscX2NO ←</code>	<code>X11 ←</code>	
<b>Front panel locks</b>			
<b>NOTE:</b> See <a href="#">Setting the Front Panel Locks (Executive Modes)</a> on page 75 for more information on the <i>Lock</i> modes.			
Lock all front panel functions	1X	<code>Exe1 ←</code>	Enable <i>Lock</i> mode 1.
Lock advanced front panel functions	2X	<code>Exe2 ←</code>	Enable <i>Lock</i> mode 2.
Unlock all front panel functions	0X	<code>Exe0 ←</code>	Enable <i>Lock</i> mode 0.
View lock status	X	<code>X3 ←</code>	
<b>NOTE:</b>			
<code>X1</code> = Input number (for tie)	<code>00</code> – (maximum number of inputs for your model) ( <code>00</code> = untied)		
<code>X2</code> = Output number	<code>01</code> – (maximum number of outputs for your model)		
<code>X3</code> = <i>Lock</i> mode	<code>0</code> = mode 0                      1 = mode 1                      2 = mode 2		
<code>X4</code> = Input number (for other than tie)	<code>01</code> – (maximum number of inputs for your model)		
<code>X9</code> = Global or room preset number	<code>00</code> - 32, 10 maximum for a room preset ( <code>00</code> = current configuration for view only)		
<code>X10</code> = Room number (for room presets)	10 max. (Each can have up to 10 presets <code>X9</code> s) assigned.)		
<code>X11</code> = Name	12 characters (upper- and lower-case alphanumeric characters and / and spaces) max.		

## Command and Response Table for SIS Commands (continued)

Command Function	SIS Command (Host to Unit)	Response (Unit to Host)	Additional description
<b>Resets</b>			
Reset global presets and names	<b>Esc</b> ZG←	Zpg←	Clear all global presets and their names.
Reset <b>one</b> global preset	<b>Esc</b> X9ZG←	ZpgX9←	Clear global preset X9.
Reset room map	<b>Esc</b> ZR←	Zpr←	Clear all room definitions.
Reset individual room	<b>Esc</b> X10ZR←	ZprX10←	Delete room X10.
Reset all room presets and names	<b>Esc</b> ZP←	Zpp←	Clear all room presets and names.
Reset individual room preset and name	<b>Esc</b> X10*X9ZP←	ZppX10*X9←	Clear an individual room preset and name.
Reset RGB delays	<b>Esc</b> ZD←	Zpd←	Reset all RGB delays to 0.0 seconds.
Reset audio input levels	<b>Esc</b> ZA←	Zpa←	Reset all audio input levels (gain and attenuation) to 0 dB.
Reset audio output levels	<b>Esc</b> ZV←	Zpv←	Reset all audio output levels (volume) to 100% (no attenuation).
Reset all mutes	<b>Esc</b> ZZ←	Zpz←	Reset all audio outputs to unmuted.
Reset whole switcher	<b>Esc</b> ZXXX←	Zpx←	Clear all ties and presets, reset all audio gains to 0 dB, and reset volume to 100%.
Absolute reset, including IP settings	<b>Esc</b> ZQQQ←	Zpq←	Similar to <b>Reset whole switcher</b> , plus clear the IP address to 192.168.254.254 and subnet mask to 255.255.000.000.
Absolute reset, excluding IP settings	<b>Esc</b> ZY←	Zpy←	Similar to <b>Absolute reset, including IP settings</b> ( <b>Esc</b> ZQQQ←), but excludes the following IP settings: IP address, subnet mask, gateway address, unit name, DHCP setting, and port mapping (telnet, web, and direct address).

**NOTE:** X9 = Global or room preset number 00 - 32, 10 maximum for a room preset (00 = current configuration for view only)  
X10 = Room number (for room presets) 10 max. (Each can have up to 10 presets (X9s) assigned.)

## Command and Response Table for SIS Commands (continued)

Command Function	SIS Command (Host to Unit)	Response (Unit to Host)	Additional description
<b>Information requests</b>			
Information request	I	V[X17]X[X18]•A[X17]X[X18]←	V (video) matrix size• A (audio) matrix size
<i>Example: MAV Plus 3216 HDA</i>	I	V32X16•A32X16←	
Request part number	N	X19←	See the Extron website, <a href="http://www.extron.com">www.extron.com</a> , for part numbers.
<p><b>NOTE:</b> There are up to three separate sets of Extron firmware on which the switcher can report: the controller firmware, which is the overall control firmware; the Ethernet protocol firmware, which handles the Ethernet interface; and the latest optional Extron firmware update, which is available at <a href="http://www.extron.com">www.extron.com</a>.</p>			
Query controller firmware version	Q	X20←	
<i>Example:</i>	Q	1.23←	The factory-installed controller firmware version is 1.23 (sample value only).
Query controller firmware version (verbose)	ØQ	X20 - X21 - X21←	Provide a detailed status of the controller firmware and any firmware upgrade. The firmware that is running is marked by an asterisk (*). A caret (^) indicates that the firmware has a bad checksum or an invalid load. ??? indicates that firmware is not loaded.
<p><i>Response description:</i> Ethernet protocol firmware version-controller firmware version-updated firmware version</p> <p><i>Example:</i> Øq See below</p> <p style="text-align: center;">             Description * indicates the version running Upload date and time              1.23-1.ØØ(1.Ø6-32x32 Series -Tue, 02 Dec 2010 00:00:00 GMT)-1.ØØ*(1.Ø6-32x32 Series -Mon, 02 Apr 2012 16:39:21 GMT)←              Ethernet protocol firmware CrossPoint or MAV firmware version Updated firmware version         </p>			
<p><b>NOTE:</b> The response to the Request system status (S) command varies, depending on the matrix size: smaller matrix sizes, up to 1616 and larger sizes, up to 3232.</p>			
Request system status	S	See below	
<b>Small matrix sizes, up to 1616:</b>	S	X22•X22•X22•X22•X23←	
<i>Response description:</i>		+3.3V•+5V•-5V•+15V•-15V•Temp←	
<i>Example (CrossPoint or MAV Plus 1616):</i>	S	3.3 V at 3.29 V Temperature is 77 °F 3.29•5.1Ø•-5.16•15.11•-15.Ø1•77.ØØ← -5 V at -5.16 V	
<b>Large matrix sizes, up to 3232:</b>	S	X22•X22•X22•X22•X22•X22•X22•X23•X24•X24•X3•X3←	
<i>Response description:</i>		+5V•+3.3V•+2.5V•Fan voltage•-5V•-12V•+12V•Temp•Fan1 RPM•Fan2 RPM•Primary PS•Secondary PS←	
<i>Example (CrossPoint or MAV Plus 3232):</i>	S	Fans receiving 11.52 V Secondary power supply is on and Ok 4.98•3.3Ø•2.55•11.52•-5.21•-12.35•11.65•78.8Ø•753•774•1•1← 5V power system at 4.98V Fan 1 rotating at 753 RPM	
<p><b>NOTE:</b> X3 = Power supply status Ø = not OK 1 = OK              X17 = Inputs Total number of inputs for this switcher              X18 = Outputs Total number of outputs for this switcher              X19 = Part number 6Ø-nnn-nn              X20 = Firmware version number to second decimal place (x.xx)              X21 = Verbose firmware version-description-upload date/time.              X22 = Voltage Positive or negative voltage and magnitude              X23 = Temperature Degrees Fahrenheit              X24 = Fan speed RPM</p>			

## Command and Response Table for SIS Commands (continued)

Command Function	SIS Command (Host to Unit)	Response (Unit to Host)	Additional description
<b>View and erase file directory</b>			
<b>NOTE:</b> The response to the View File Directory command differs, depending on whether the command is sent via an RS-232, RS-422, or Telnet connection or sent via a Web browser connection.			
View file directory RS-232/RS-422 port and Telnet	<code>[Esc]DF←</code>	See below:  <code>filename1•date/time•length↵</code> <code>filename2•date/time•length↵</code> <code>filename3•date/time•length↵</code> <code>•</code> <code>•</code> <code>•</code> <code>•</code> <code>filename•date/time•length↵</code> <code># of•Bytes•Left↵↵</code>	List user-supplied files.
View file directory Web browser	<code>[Esc]DF←</code>	See below:  <code>Var•file•=•new•array•()</code> ; <code>File•[1]•=•'filename1,date1,filesize1'</code> ; <code>File•[2]•=•'filename2,date2,filesize2'</code> ; <code>File•[3]•=•'filename3,date3,filesize3'</code> ; <code>•</code> <code>•</code> <code>•</code> <code>•</code> <code>File•[n]•=•'filenamen,daten,filesize'</code> ; <code>File•[n+1]•=•# of•Bytes•Left</code>	List user-supplied files.
Erase user-supplied web pages/files	<code>[Esc]filenameEF←</code>	<code>Del•filename↵</code>	



# Command and Response Table for IP- and Remote Port Specific SIS Commands

## Symbol definitions

**X30** = Matrix name (Up to 24 alphanumeric characters)

**NOTE:** The HTML language reserves certain characters for specific functions (see [Special Characters](#) on page 109).

**X31** = Default name

*Mode1 name* + last 3 pairs of MAC address. *nn* = 16 or 32.

**X32** = Time and date (for set)

In the format: MM/DD/YY•HH:MM:SS *where*:  
 MM = month: 01 (January) through 12 (December)  
 DD = 01 through 31  
 YY = 00 through 99  
 HH = 00 through 23  
 MM = 00 through 59  
 SS = 00 through 59

**X33** = Time and date (for read)

In the format: Day,•DD•Mmm•YYYY•HH:MM:SS *where*:  
 Day of the week: Mon through Sun  
 DD = 01 through 31  
 Mmm = month: Jan through Dec  
 YYYY = 2000 through 2099  
 HH = 00 through 23  
 MM = 00 through 59  
 SS = 00 through 59

**X34** = GMT offset

-12.0 through +14.0. Hours and minutes removed from GMT

**X35** = Daylight Savings Time

0 = Daylight Savings Time off or ignore  
 1 = Daylight Savings Time on (North America)  
 2 = Daylight Savings Time on (Europe)  
 3 = Daylight Savings Time on (Brazil)

**X36** = IP address

###.###.###.###

**X37** = Hardware (MAC) address

##-##-##-##-##-##

**X38** = Number of open connections

000 - 200

**X39** = Password

Up to 12 alphanumeric characters

**NOTE:** The HTML language reserves certain characters for specific functions (see [Special Characters](#) on page 109).

**X40** = Domain name

Standard domain name rules apply (for example: xxx.com)

**NOTE:** The HTML language reserves certain characters for specific functions (see [Special Characters](#) on page 109). The @ character is acceptable only as the lead-in to the domain name (such as @extron.com).

**X41** = E-mail account

65 - 72. 65 = e-mail recipient 1, 66 = 2, 67 = 3, ... 72 = recipient #8

**X42** = E-mail address

Typical e-mail address format (for example: nnnn@xxx.com)

**X43** = Notify when?

0 = no response      3 = both 1 & 2  
 1 = fail or missing      4 = suspend  
 2 = fixed or restored

**X44** = Notification selections

**Matrix size 2412 and larger:** 01 - 32 = input 1 through input 32  
 98 = power supplies  
 99 = fans  
**Matrix size 1616 and smaller:** 01 - 17 = input 1 through input 16  
 17 = power supply

**X45** = Notify status (for read)

34- or 17-digit number. For each digit: 0 = do not notify, 1 = notify

**X46** = DHCP

0 = off, 1 = on

**X47** = Port number

00 = All ports  
 01 = Rear panel Remote RS-232/RS-422 port  
 02 = Front panel Configuration port

**X48** = Baud rate

9600, 19200, 38400, 115200

**X49** = Parity

odd, even, none, mark, space (only the first letter required)

**X50** = Data bits

7, 8

**X51** = Stop bits

1, 2

**X52** = Port type

0 = RS-232  
 1 = RS-422

**X53** = Verbose mode

∅ = clear/none (default for Telnet connection)  
 1 = verbose mode (default for RS-232/RS-422 connection)  
 2 = tagged responses for queries  
 3 = verbose mode and tagged for queries

**NOTE:** If tagged responses is enabled (modes 2 and 3), all read commands return the constant string and the value as the set command does (for example, the read matrix name command **Esc**CN←, returns Ipn•**X31**←←).

**X54** = Flow control

hardware, software, none (only the first letter required)

**X55** = Data pacing (in ms between bytes)

0000 (default) - 1000

**X56** = Time (in 10 ms increments) to wait for characters

10 (= 100 ms, default) - 32767

**X57** = Time (in 10 ms increments) between characters

2 (= 20 ms, default) - 32767

**X58** = Port timeout interval (in 10-second increments)

1 (= 10 seconds) - 65000 (default is 30 = 300 seconds = 5 minutes)

## SIS Command and Response Table for IP- and Remote Port-Specific Commands

Command Function	SIS Command (Host to Unit)	Response (Unit to Host)	Additional description
<b>IP and Remote port setup commands</b>			
Set matrix name	<b>Esc</b> X61CN←	Ipn•X30←←	
Read matrix name (location)	<b>Esc</b> CN←	X30←←	
Reset matrix name to factory default	<b>Esc</b> •CN←	Ipn•X31←←	
Set time and date	<b>Esc</b> X32CT←	IptX32←←	
Read time and date	<b>Esc</b> CT←	X33←←	
Set GMT offset	<b>Esc</b> X33CZ←	IpzX33←←	In the command, the divider between hours and minutes can be either a colon or a period. In the response, the divider is a colon. 8.3 = 8:30
<i>Example:</i>	<b>Esc</b> 8.3CZ←	Ipz+08:30←←	
Read GMT offset	<b>Esc</b> CZ←	X34←←	
Set Daylight Savings Time	<b>Esc</b> X35CX←	X35←←	
Read Daylight Savings Time	<b>Esc</b> CX←	X35←←	
Set IP address	<b>Esc</b> X36CI←	IpiX36←←	Default: 192.168.254.254
Read IP address	<b>Esc</b> CI←	X36←←	
Read hardware address	<b>Esc</b> CH←	X37←←	Reads MAC address.
Read # of open connections	<b>Esc</b> CC←	X38←←	
Set subnet mask	<b>Esc</b> X38CS←	IpsX38←←	Default: 255.255.0.0
Read subnet mask	<b>Esc</b> CS←	X38←←	
Set gateway IP address	<b>Esc</b> X38CG←	IpgX38←←	Default: 0.0.0.0
Read gateway IP address	<b>Esc</b> CG←	X38←←	
Set administrator password	<b>Esc</b> X39CA←	Ipa•X39←←	
Read administrator password	<b>Esc</b> CA←	X39←←	
Reset (clear) administrator password	<b>Esc</b> •CA←	Ipa•←←	
Set user password	<b>Esc</b> X39CU←	Ipu•X39←←	
Read user password	<b>Esc</b> CU←	X39←←	
Reset (clear) user password	<b>Esc</b> •CU←	Ipu•←←	
Set mail server, domainname	<b>Esc</b> X36, X40, X39CM←	IpmX36, X40, X39←←	
Read mail server, domainname	<b>Esc</b> CM←	X36, X40, X39←←	
Set e-mail recipient	<b>Esc</b> X41, X42CR←	IprX41, X42, ←←	This command sets the recipient. To receive e-mail notifications, you must then set the events that the switcher reports, using one or more separate Set e-mail events (EM) commands (see the next page).
<i>Example:</i>	<b>Esc</b> 72,Jsmith@folklore.netCR←	Ipr72,Jsmith@folklore.net, ←←	
Read e-mail recipient	<b>Esc</b> X41CR←	X42, X44←←	



# Matrix Software

This section introduces the following software programs, which are available on the Extron website ([www.extron.com](http://www.extron.com)):

- **Matrix Switchers Control Program**
- **Button-Label Generator Program**

## Matrix Switchers Control Program

The Windows®-based Extron Matrix Switchers Control Program provides an easy way to set up ties and sets of ties. The program is compatible with Windows 2000, Windows XP, and later. Updates to this program can be downloaded from the Extron website ([www.extron.com](http://www.extron.com)).

The program communicates with the switcher via the following ports:

**Rear panel LAN port** — A password-protected RJ-45 connection (see **Ethernet** on page 27 and “Software Operation via Ethernet,” below).

**Rear panel Remote RS-232/RS-422 port** — A 9-pin D connector for serial RS-232 or RS-422 control (see **Remote port** on page 26 and **Software Operation via a Serial Port**, on the next page).

**Front Panel Configuration port (for certain models only)** — A 2.5 mm mini stereo jack for serial RS-232 control only (see **Front Panel Configuration Port (All Matrix Sizes up to 1616, and MAV Plus 248A and MAV Plus 328A Only)** on page 30 and **Software Operation via a Serial Port**, on the next page).

## Software Operation via Ethernet

When a matrix switcher is connected to an Ethernet WAN or LAN, up to 200 users can be connected to operate it, locally or remotely, using the Matrix Switchers Control Program (see **Ethernet** on page 27 for installation details).

Connection to the switcher via the Ethernet is password protected. There are two levels of password protection:

- Administrators have full access to all Matrix switching capabilities and editing functions.
- Users can select inputs and outputs, set and recall presets, and view all settings with the exception of passwords.

If the same password or no password is required for logging on, all personnel log on with administrator privileges. Fields and functions that exceed user privileges are not available in the Matrix Switchers Control Program when the operator is logged on as a user.

### Ethernet protocol settings

The IP Settings/Options window (see **figure 66** on page 115) provides a location for viewing and, if connected via a serial port or if logged on via the LAN port as an administrator, editing settings unique to the Ethernet interface.

## Software Operation via a Serial Port

- The serial ports are independent of one another. A front panel Configuration port connection and a rear panel Remote RS-232/RS-422 port connection can be active at the same time.
- The default serial port protocol of both ports is as follows:
  - 9600 baud
  - No parity
  - 8-bit
  - No flow control
  - 1 stop bit
- The serial ports can be configured to operate at the 9600, 19200, 38400, or 115200 baud rate but Extron recommends leaving these ports at 9600 baud only.
- See the **Serial port parameters** SIS commands on page 109 to configure either port using an SIS command.

## Installing the Software

The Matrix Switchers Control Program and Firmware Loader are available on the Extron website, [www.extron.com](http://www.extron.com). Download and install both programs as follows:

**NOTE:** Steps 1 through 5, below, are also used to download firmware update packages.

1. Visit the Extron website, [www.extron.com](http://www.extron.com), and click the **Download** link (see figure 61).

The screenshot shows the Extron website's Download Center. The navigation menu includes Products, Training, Markets, Tech Library, Company, and Download. The main content area displays a list of software files, with 'Matrix Switchers' selected. The details for 'Matrix Switchers' show it is updated, version 8.3, and 15.0 MB. A registration form is displayed, requiring the user to provide their name, company, title, and email address. The 'Download MATRIX\_SW\_v8x3.exe' button is highlighted. A Windows security warning dialog is shown at the bottom, asking if the user wants to run or save the file.

1. Visit the Extron website, [www.extron.com](http://www.extron.com), and click the **Download** link (see figure 61).

2. Click the **Software** or **Firmware** link as appropriate to the operation you are performing.

3. Select the desired software or firmware file to download and click **Download**.

4. Provide the required information in the registration form.

5. Click the **Download MATRIX\_SW\_v8x3.exe** button.

6. Click the **Run** button in the Windows security warning dialog.

**Figure 61. Downloading a Software or Firmware Package**

2. Click the **Software** or **Firmware** link as appropriate to the operation you are performing.
3. Select the desired software or firmware file to download and click **Download**.

4. Enter the requested personal information;

**TIP:** Click **Remember Me** to eliminate step 4 in future downloads.

5. Click **Download** to copy the software or firmware to your computer.
6. **For a software download**, click **Run** to confirm that you want to run the installation.
7. **For a firmware download**, exit this procedure and return to **Updating Firmware** on page 119 or **Firmware Upgrade Page** on page 140.
8. Follow the on-screen instructions. By default, for the Matrix Switchers Control Program, the installation creates a C:\Program Files\Extron\Matrix\_Switchers directory, and it places the following four icons into a group folder named “Extron Electronics\Matrix Switchers:”

**NOTE:** C:\Program Files(x86) \ ... for Windows 7 or Windows 8.

- MATRIX Switcher + Control Program
- MATRIX Switcher + Help
- Check for Matrix Updates
- Uninstall MATRIX Switcher

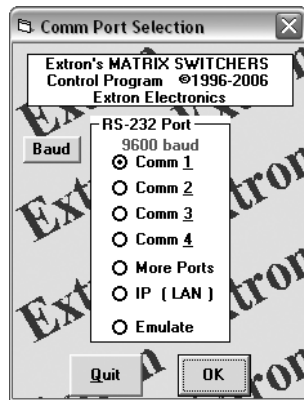
## Using the Matrix Switcher Control Software

Many items found in the Matrix Switchers Control Program are also accessible via front panel controls (see **Front Panel Operations** on page 40) and under SIS control (see **Command and Response Table for SIS Commands** on page 95). The Matrix Switcher Help Program provides information on settings and on how to use the control program itself.

1. To run the Matrix Switchers Control Program, click **Start** > **Programs** > **Extron Electronics** > **Matrix Switchers** > **MATRIX Switcher+ Control Pgm.**



The Comm Port Selection window (see figure 62) opens.



**Figure 62.** Comm Port Selection Window

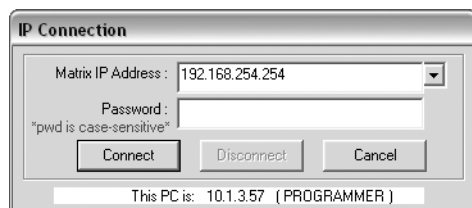
2. Choose the comm port that is connected to the rear panel RS-232/RS-422 port of the CrossPoint or MAV switcher or to the front panel Config port (matrix sizes up to 1616, and MAV Plus 248A and MAV Plus 328A), **IP [LAN]**, or **Emulate**.
  - **If you selected a comm port**, check the baud rate displayed. If you need to change the baud rate, click on the **Baud** button and double-click on the desired baud rate.

**NOTE:** If you need to change the baud rate, click the **Baud** button and double-click the desired baud rate. The default is 9600.

9600 baud  
19200 baud  
38400 baud  
115200 baud

Click **OK** and proceed to step 4. The Extron Matrix Switchers Control Program window (see [figure 64](#) and [figure 65](#) on the next page) appears, displaying the current configuration of the attached matrix. Proceed to step 4.

- If you selected **IP [LAN]**, click **OK** and proceed to step 3.
  - If you selected **Emulate**, click **OK** and see [Using Emulation mode](#) on page 127.
3. If you selected **IP [LAN]** in step 2, the IP Connection window appears (see [figure 63](#)).



**Figure 63. Address and Password Entry**

- a. Examine the Matrix IP Address field in the IP Connection dialog box. The field displays the last Matrix IP address entered.

**If the IP address is correct:** Proceed to step 3b.

**If the address is not correct:** Either click in the **Matrix IP Address** field and enter the IP address or click on the scroll down button (▼) and select from among the recently used addresses. Proceed to step 3b.

**NOTE:** If the local system administrators have not changed the value, the factory-specified default, 192.168.254.254, is the correct value for this field.

- b. If the switcher is password protected, click in the **Password** field and enter the appropriate administrator or user password.
- c. Click **Connect**. The Extron Matrix Switchers Control Program window (see [figure 64](#) and [figure 65](#) on the next page) appears, displaying the current configuration of the attached matrix. Proceed to step 4.

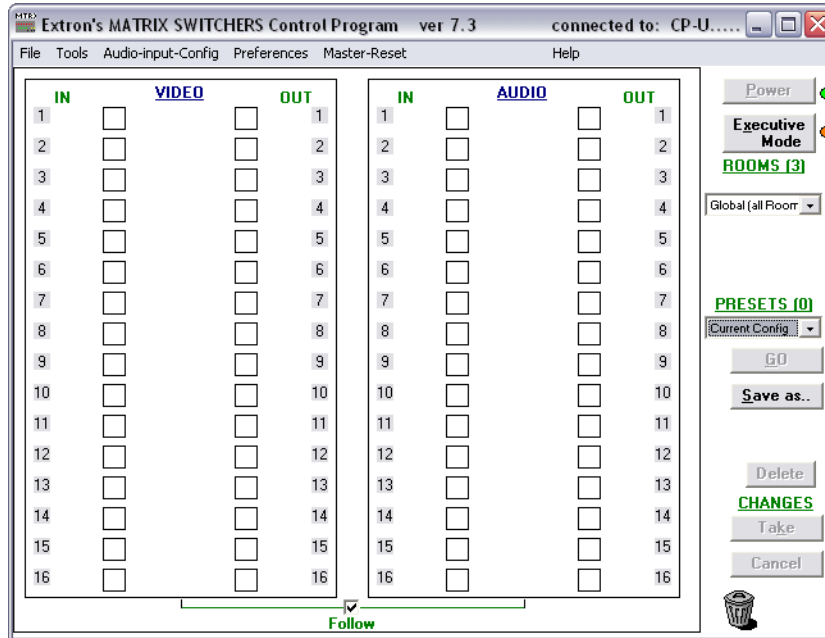
If you logged on using the administrator password, the program connects you to the CrossPoint or MAV switcher with all of the administrator rights and privileges.

If you logged on using the user password, the program connects you to the CrossPoint or MAV switcher with only user capabilities.

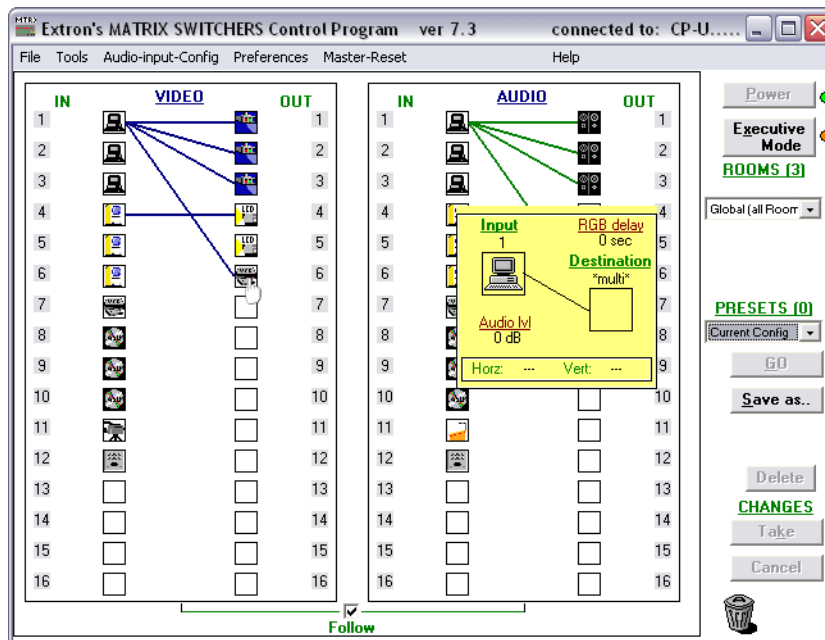
If an incorrect password was entered, the program beeps and returns to the password entry display.

4. Operate the switcher as desired.
- To create a tie, drag an input box to one or more output boxes. To remove a tie, drag the output box to its tied input box or to the trash can.
  - To set up audio in *Follow* mode (audio and video have the same tie configuration), select the **Follow** box at the bottom of the window. To set up audio in breakaway mode (audio and video have different tie configurations), deselect the **Follow** box.
  - To make the control program easier to use, assign a device icon to each input and output. Click on a box that represents an input or output, and drag the desired icon onto the box from the icon palette that appears.
  - For quick display of information on a specific input or output device, position the cursor over that device in the control program window. The program opens a window that details the connection to that device (see the inset box in [figure 65](#)).

**TIP:** Click **File > Print Tie Map** to print a map of the current configuration.



**Figure 64.** Extron Matrix Switchers Control Program Window (no Icons or Ties)



**Figure 65.** Sample Program Window (Icons Assigned and Ties Created)



## IP Settings/Options window

The IP Settings/Options window (click **Tools** > **IP options**, see figure 66) provides a location for viewing and, if connected via the either serial port or if you are logged on via the LAN port as an administrator, editing settings unique to the Ethernet interface. See the **Ethernet Link** section, beginning on page 149 for basic information about IP addresses. None of the fields on this screen can be edited while you are logged on as a user.

Figure 66. Control Program IP Setting/Options Window

### NOTES:

- Editing variables in the IP Settings/Options window while connected via the Ethernet port can immediately disconnect the user from the switcher. Extron recommends editing the settings on this screen using a serial port and protecting the Ethernet access to this screen by assigning an administrator password to qualified and knowledgeable personnel only.
- When the control program is connected to the switcher via the RS-232 link, the **Administrator Password** and **User Password** fields are not masked. If a password has been inadvertently changed to an unknown value, you can look up and, if desired, change a password in this window without knowing the current password.

### Address and Name fields

The **Matrix IP Address** field contains the IP address of the connected matrix switcher. This value is encoded in the flash memory in the switcher.

The **Gateway IP Address** field identifies the address of the gateway to the controlling PC to be used if the matrix switcher and the mail server are not on the same subnet.

The **Subnet Mask** field is used to determine whether the matrix switcher is on the same subnet as the controlling PC when you are subnetting. For more information, see **Subnetting — A Primer** section on page 154.

The **Mail Server IP Address** field displays the IP address of the mail server that handles the e-mail for the facility in which the matrix switcher is installed.

Valid addresses consist of four 1-, 2-, or 3-digit numeric subfields, properly called octets, separated by dots (periods). Each octet can be numbered from 000 through 255. Leading zeroes, up to 3 digits total per field, are optional. Values of 256 and above are invalid.

The default addresses are as follows, but if these conflict with other equipment at your installation, you can change the addresses to any valid value:

- **IP address** 192.168.254.254
- **Gateway address** 0.0.0.0
- **Subnet mask** 255.255.0.0

**NOTES:**

- The address fields are unavailable when DHCP is selected.
- Editing the addresses while connected via the Ethernet port can immediately disconnect the user from the switcher. Extron recommends editing this field using one of the RS-232 ports and protecting the Ethernet access by assigning an administrator password to qualified and knowledgeable personnel only.

The **Extron Name/Descriptor** field contains the name of the matrix switcher. This descriptor can be changed to any valid name, up to 12 alphanumeric characters.

The **Mail Server Domain Name** field displays the domain name that the matrix switcher uses to log on to the e-mail server. Standard domain conventions (such as xxx.com) apply.

**NOTE:** Certain characters are reserved for specific functions (see [Special Characters](#) on page 109). In the **Mail Server Domain Name** field, the @ character is only acceptable as the lead-in to the domain name (such as *@folklore.net*).

Edit any of these fields as follows:

1. Click in the desired field. The graphic cursor becomes a text cursor.
2. Edit the address or name as desired.
3. Press the <Tab> key on the keyboard or click in another field to exit the field.
4. Click the **Take** button to make the address change take affect.

### **Hardware Address field**

The hardware address is hardcoded in the matrix switcher and cannot be changed.

### **Use DHCP check box**

The **Use DHCP** check box directs the matrix switcher to ignore any entered IP addresses and to obtain its IP address from a Dynamic Host Configuration Protocol (DHCP) server (if the network is DHCP capable). Contact the local system administrator to determine whether to use DHCP.

### **Date, Time (local), and GMT (offset) fields**

The **Date** field displays the current date in the Greenwich Mean Time zone.

The **Time (local)** field displays the current time in the local time zone.

The **GMT** field displays the amount of time, in hours and minutes, that the local time varies from the GMT international time reference.

**NOTE:** Rather than the following procedure, you can click the **Sync Time to PC** button to set the switcher to the internal time of your computer.

If desired, adjust any of these values as follows:

1. Click in the desired field. The field changes to an editable field appropriate to the value being change and the graphic cursor becomes a text cursor.
  - The **Date** field becomes a set date field, with the date in the format (M)M/(D)D/YYYY. Leading zeroes are not shown. Date :
  - The **Time (local)** field becomes a set time field, with the time in the format HH:MM:SS (00:00:00 to 23:59:59). Time (local) :
  - The **GMT** field becomes a set offset field, with the offset in the format ±HH:MM (-12:00 to +14:00). GMT
2. Edit the field as desired to set the proper proper value. For time, remember to use 24-hour time. Leading zeroes are optional.
3. Press the <Tab> key on the keyboard or click in another field to exit the set date field.
4. Click the **Take** button to make the date change take affect.

### **Sync Time to PC button**

Clicking the **Sync Time to PC** button causes the computer you are operating to send its internal time to the switcher in a set time command.

### **Use Daylight Saving check box**

Click in the **Use Daylight Saving** checkbox to turn Daylight Saving Time on and off for North America. When Daylight Saving Time is turned on, the switcher automatically updates its internal clock between Standard Time and Daylight Saving Time in the spring and fall on the date that the time change occurs in North America. When Daylight Saving Time is turned off, the switcher does not adjust its time reference.

**NOTE:** For Daylight Saving Time in Europe and Brazil, see to the **Set Daylight Saving Time** SIS command on page 108.

### **Administrator Password and User Password fields**

The Administrator Password field displays the password required to log on to the matrix switcher via the Ethernet port with all of the rights and privileges of the administrator. The User Password field displays the password required to log on to the matrix switcher via the Ethernet port as a user, without all of the rights and privileges of the administrator. Passwords are case sensitive and are limited to 12 upper-case and lower-case alphanumeric characters.

Both password fields are masked with asterisks (\*\*\*\*\*) as a security measure.

#### **NOTES:**

- Editing the Administrator Password field while connected via the Ethernet port can immediately disconnect the user from the switcher. Extron recommends editing this field using either serial port and protecting the Ethernet access to this screen by assigning an administrator password to qualified and knowledgeable personnel only.
- An administrator password must be created before a user password can be created.
- The HTML language reserves certain characters for specific functions (see **Special Characters** on page 109).

Edit either password field as follows:

1. Click in the desired **Password** field. The pointer tool becomes a text cursor.
2. Edit the case-sensitive password as desired.
3. Press the <Tab> key on the keyboard or click in another field to exit the Password field.
4. Click the **Take** button to make the password change take effect.

### Mail Server IP Address field

The **Mail Server IP Address** field displays the IP address of the mail server that handles the e-mail for the facility in which the matrix switcher is installed. Standard IP protocol rules apply to the Mail Server IP address.

Edit this field as follows:

1. Click in the **Mail Server IP Address** field. The pointer tool becomes a text cursor.
2. Edit the IP address as desired.
3. Press the <Tab> key on the keyboard or click in another field to exit the **Mail Server IP Address** field.
4. Click the **Take** button to make the address change take effect.

### Mail Server Domain Name field

The **Mail Server Domain Name** field displays the domain name that the matrix switcher uses to log on to the e-mail server. Standard domain conventions (such as xxx.com) apply.

**NOTE:** The HTML language reserves certain characters for specific functions (see [Special Characters](#) on page 109). In the **Mail Server Domain Name** field, the @ character is only acceptable as the lead-in to the domain name (such as [@folklore.net](#)).

Edit this field as follows:

1. Click in the **Mail Server Domain Name** field. The pointer becomes a text cursor.
2. Edit the name as desired.
3. Press the <Tab> key on the keyboard or click in another field to exit the **Mail Server Domain Name** field.
4. Click the **Take** button to make the name change take effect.

### E-mail Addressee fields

The five E-mail Addressee fields permit the administrator to identify the e-mail addresses of the personnel to whom the matrix switcher e-mails notification of its failure and repair status. Figure 67 shows a typical e-mail from the switcher.

<b>Miles Standish</b>	
<b>From:</b>	Crosspoint/MAV/Matrix-FF-FF-09@folklore.net
<b>Sent:</b>	Thursday, May 18, 2006 10:05 AM
<b>To:</b>	Miles Standish
<b>Subject:</b>	Crosspoint/MAV/Matrix-FF-FF-09 - Input #10 Signal Available
Thu, 18 May 2006 10:05:07	
Unit Name = Crosspoint/MAV/Matrix-FF-FF-09	
Unit IP Address = 192.168.254.254	

**Figure 67.** Typical Matrix Switcher E-mail

The radio buttons and check boxes associated with each address field permit the administrator to specify specific e-mail requirements for each recipient.

Edit these fields and controls as follows:

1. Click in the desired E-mail Addressee field. The graphic cursor becomes a text cursor.
2. Edit the e-mail address as desired. Standard e-mail address conventions (for example: *nnnnn@xxx.com*) apply.
3. Press the <Tab> key on the keyboard or click in another field to exit the e-mail addressee field.
4. In the square associated with each addressee, select one or more options about which the addressee is to be e-mailed: missing input(s), fans, and power supply. In the floating box that contains the input numbers, select the inputs to be monitored.
5. In the round radio buttons associated with each addressee, select whether the addressee is to be e-mailed of failures, fixes, both, or not be notified. The **None** radio button is useful for temporarily removing personnel from the e-mail list when they are unavailable, such as on travel or vacation.
6. If desired, click the **Send test E-mail** button to test the e-mail function.
7. Click the **Take** button to make the e-mail address changes take affect.

## Updating the Firmware

The firmware upgrade utility provides a way to replace the firmware that is coded on the control board of the switcher without taking the switcher out of service.

**NOTE:** Upgrading the firmware does not overwrite the current configuration or presets.

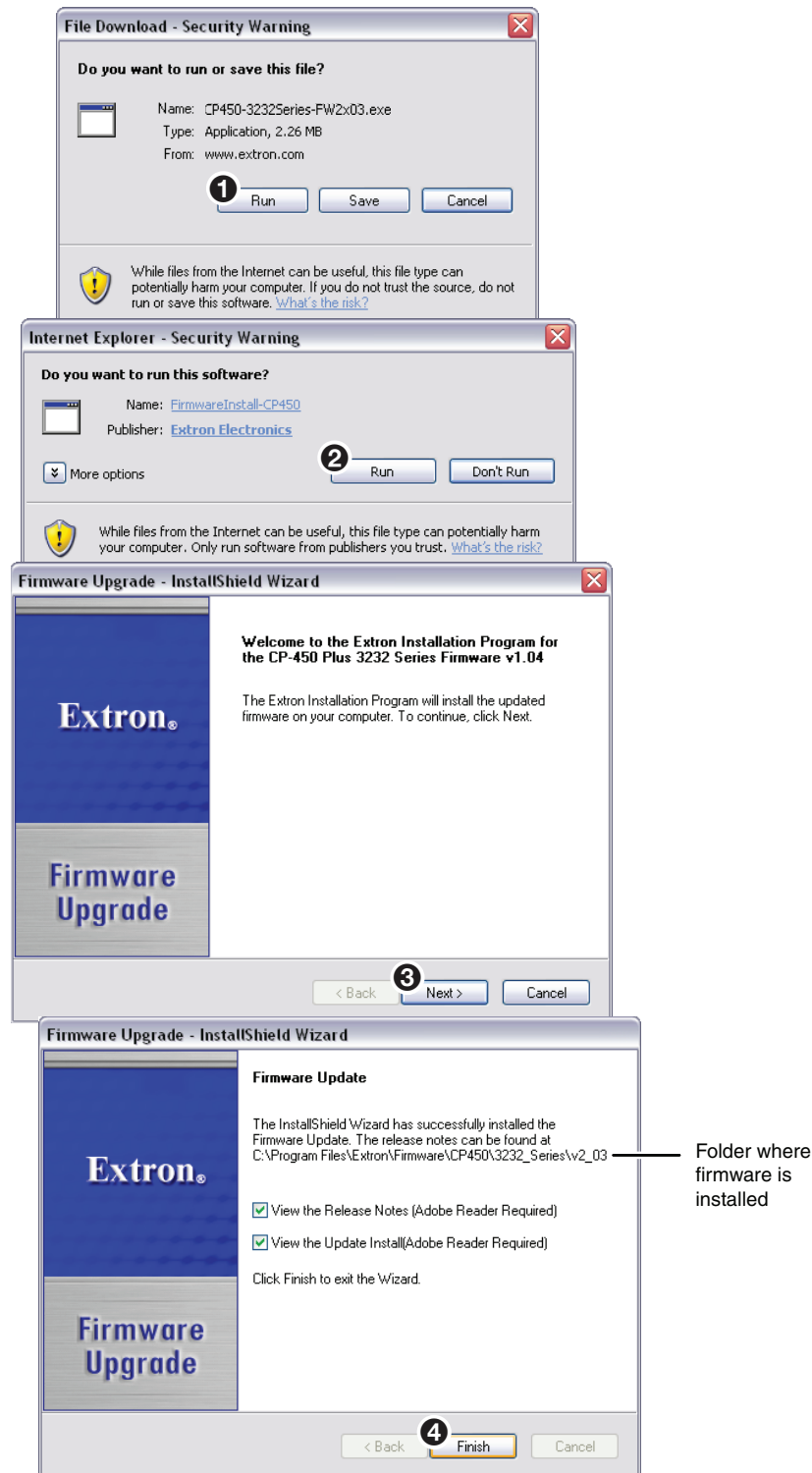
Update the switcher firmware as follows:

1. Perform steps 1 through 5 of **Installing the Software**, on page 111, to download the firmware upgrade from the Extron website, [www.extron.com](http://www.extron.com).
2. Click **Run** in the File Download and Security Warning dialog boxes (see **figure 68**, ❶ and ❷, on the next page). The PC downloads the firmware update from the Extron website and starts the Extron Installation Program to extract the firmware file.
3. Click **Next** (see **figure 68**, ❸). The program extracts the firmware files and places them in a folder identified in the InstallShield Wizard window.

### NOTES:

- **Note the folder to which the firmware file is saved.** When downloaded from the Extron website, the firmware is placed in a subfolder of:
  - **Windows 7 or Windows 8:** C:\Program Files (x86)\Extron\Firmware.
  - **Older versions:** C:\Program Files\Extron\Firmware.
- The original factory-installed firmware is permanently available on the matrix switcher. If the attempted firmware upload fails, the switcher reverts to the factory-installed firmware.

4. Click **Finish** (see **figure 68**, ❹) to exit the program.

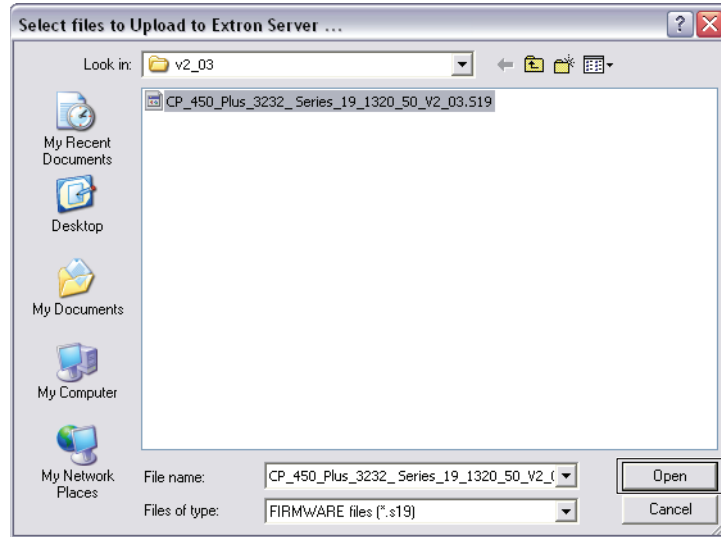


**Figure 68. Downloading Firmware Upgrade Files**

5. Connect a Windows-based computer to either the Remote RS-232/RS-432 port (see item ③ on [page 26](#)), the front panel Configuration port (if equipped, see item ① on [page 30](#)) or the LAN port (see item ⑨ on [page 27](#)) of the switcher.
6. If necessary, start the Matrix Switchers Control Program and connect to the matrix switcher (see [Using the Matrix Switcher Control Software](#), steps 1 through 3, starting on page 112).

7. Click **Tools > Update firmware...**

- **If the switcher is connected via the LAN port**, the select file window appears (see figure 69 and “Ethernet-connected firmware upload,” below).



**Figure 69. Select File Window**

- **If the switcher is connected via either serial port**, the Extron Firmware Loader window appears (see [figure 70](#) and [Serial-port-connected firmware upload](#) on the next page).

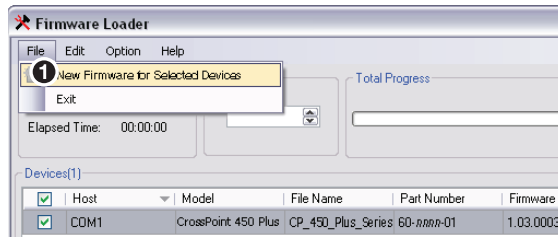
***Ethernet-connected firmware upload***

1. Navigate to the folder where you saved the firmware upgrade file. Select the file.
2. Click the **Open** button. The software advises you that you are about to reprogram the switcher firmware. Click **OK** to continue.

A status window, which shows the progress of the upload, appears. The firmware upload to the matrix switcher may take a few minutes.

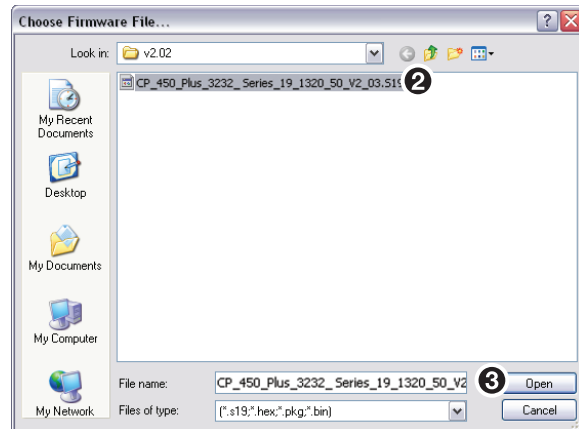


## Serial-port-connected firmware upload



**Figure 70. Extron Firmware Loader Window**

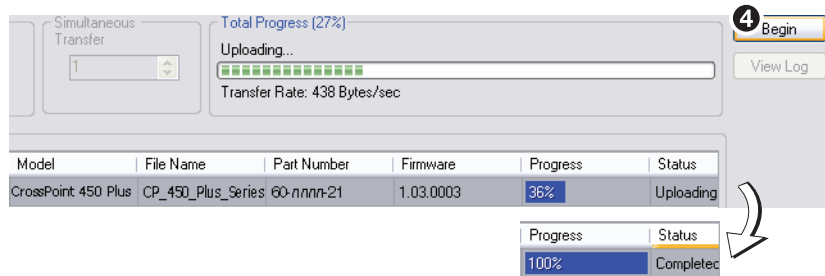
1. Select the matrix switcher and click **File > New Firmware for Selected Devices** (see figure 70, ①). The Choose Firmware File dialog box opens (see figure 71).



**Figure 71. Choose Firmware File Window**

2. Navigate to and select the new firmware file (see figure 71, ②). Click **Open** (see figure 71, ③). The Choose Firmware File window closes.
3. In the Firmware Loader window, click **Begin** (see figure 72, ④).

The Total Progress and Progress status bars show the upload progress. The firmware upload may take several minutes. Once the status bars have progressed from 0% to 100%, and Status is listed as **Complete**, the firmware loader utility resets the switcher.



**Figure 72. Firmware Loader Screen**

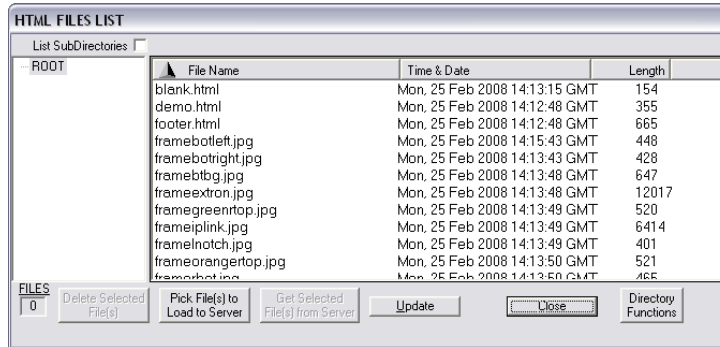
4. Click **Exit** to close the Firmware Loader.

**NOTE:** The firmware loader increases the baud rate to 115,200. The firmware loader may not return the serial port to its earlier baud rate, making communications with the switcher impossible. If you cannot communicate with the switcher after a firmware upload, change the baud rate on your computer and, if desired, change the baud rate using the **Set serial port parameters** SIS command on page 109.



## Uploading HTML Files

You can create customized HTML pages for the switcher to display. The HTML Files List window (see figure 73) provides a way to view the contents of the switcher file system and to upload custom HTML pages to the switcher.



**Figure 73. HTML Files List Window**

Upload HTML pages as follows:

### NOTES:

- The files listed in figure 73 are shown for example only and may not be present on your switcher.
- The HTML Files List window is for inserting your custom HTML pages. This is **not** the window to replace the firmware that controls all switcher operation. See [Updating firmware](#), on page 119, to replace the firmware.
- The following characters are invalid or not recommended in file names:  
<space> + ~ , @ = ' [ ] { } < > " ' ; : | \ and ?.

1. Connect the PC to the CrossPoint or MAV switcher via either serial port or the LAN port.
2. If necessary, start the Matrix Switchers Control Program and connect to the CrossPoint or MAV switcher (see [Using the Matrix Switcher Control Software](#), steps 1 through 3, starting on page 112).
3. Click on **Tools > HTML File Manager**.
4. Click the **Pick File(s) to Load to Server** button. An open file dialog box appears.
5. Navigate to the folder where you saved one or more HTML files. Select the files.

### NOTES:

- To select multiple files, hold the <Ctrl> key while you select the desired files.
- If you want one of the custom HTML files that you created to be the default start-up page, name the file "index.html". The switcher looks for that file name when you first connect to it using an Internet browser.

6. Click the **Open** button. The files upload to the CrossPoint or MAV switcher may take a few minutes.
7. Click the **Update** button to confirm the upload.
8. Click the **Close** button to exit the HTML Files List window.

## Windows Buttons, Drop Boxes, and Trash Can

The buttons, drop boxes, and trash can on the right side of the Matrix Switchers Control Program window perform the following functions:

**Power** — Unavailable for CrossPoint and MAV matrix switchers.

**Executive Mode** — Allows you to lock out front panel operations, except for the view-only mode functions. Click the button to cycle between Lock mode 0 (the indicator is white), Lock mode 1 (the indicator displays red), and Lock mode 2 (orange).

**NOTE:** See [Setting the Front Panel Locks \(Executive Modes\)](#) on page 75 for more information on the Lock modes.

**Rooms menu** — Displays a list of up to 10 rooms. You can select a room from the list to display it in the window.

**NOTE:** A *Room* is a subset of outputs that are logically related to each other, as determined by the operator. The matrix switcher supports up to 10 rooms, each of which can consist of from 1 to 16 outputs.

**Presets menu** — Displays a list of up to 32 global presets and up to 100 room presets (10 rooms x 10 presets per room). You can select a preset from the list to display it in the window and either activate it (**Go**) or delete it (**Delete**).

**Go** — Activates the selected preset as the current configuration.

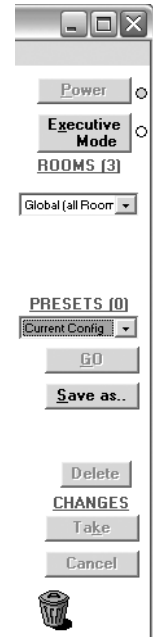
**Save as ...** — Allows the current set of ties to be saved as a preset. Enter the preset number when prompted to do so.

**Delete** — Allows the current preset to be deleted.

**Changes – Take** — Allows you to execute any potential changes made to the displayed configuration.

**Changes – Cancel** — Returns to the previous screen, undoing any changes you have made.

**Trash can** — Drag and drop from an input or output button to the trash can to erase all ties associated with that input or output.



## Windows Menus

### File menu

**Save Matrix settings as ...** — Saves a complete set of up to 64 presets, rooms, room presets, and preset names plus the last active setting (preset 0), to a file. Saved settings include assigned icons and icon captions.

**Restore Matrix settings from ...** — Loads and activates a previously saved setting file.

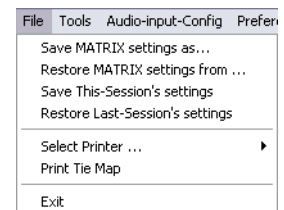
**Save This-Session's settings** — Saves the current assigned icons and icon captions.

**Restore Last-Session's settings** — Loads the icons and icon captions that were saved during the last session. If you saved changes from the previous session to disk, the last time you exited the program, the ties from that session are also loaded.

**Select printer ...** — Selects the target printer.

**Print tie map** — Prints the tie set that is displayed on the screen.

**Exit** — Closes the Matrix Switchers Control Program.



## Tools menu

**Assign device icons** — Displays the complete set of input and output device icons. You can drag any of these icons to the input and output boxes.

**Edit device palette** — Allows you to add your own custom device icon graphics.

**RGB delay settings** — Displays the switching interval setting for each input and allows you to change them.

**Audio-Input gain settings** — Displays the audio gain level setting for a single input or for all inputs and allows you to change it. The level is expressed as the magnitude (number of decibels) and polarity (positive, gain or negative, attenuation) of the audio adjustment.

**Audio-Output volume settings** — Displays the audio output level setting for a single input or for all inputs and allows you to change it. The level is expressed as a percentage of the input audio volume that is applied to the output; 0% is full attenuation (audio is silent), 100% is full volume.

**Mute-Output settings** — Displays the RGB Delay, Volume, and Mute Adjust screen, which allows you to mute and unmute individual or all video or audio outputs.

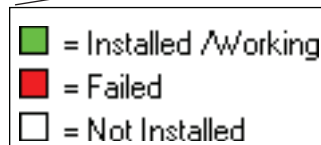
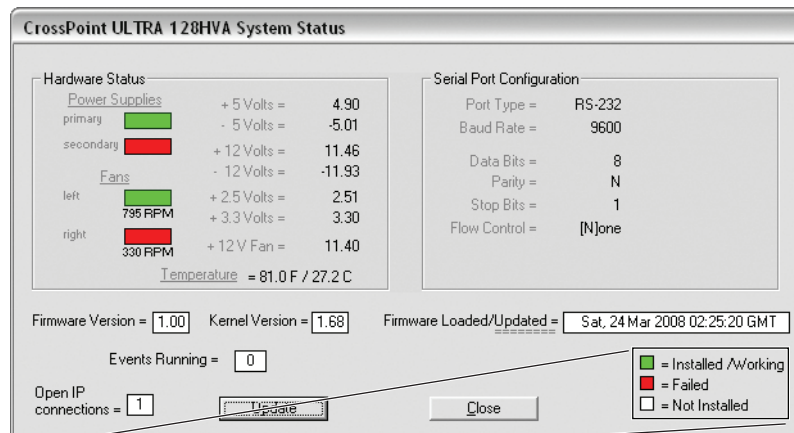
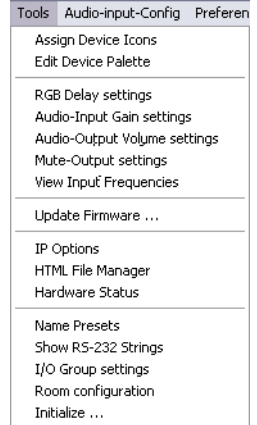
**View input frequencies** — (DSVP) Displays the input horizontal and vertical frequencies for each input.

**Update firmware** — Allows you to replace the switcher firmware without taking the switcher out of service. See [Updating Firmware](#) on page 119.

**IP options** — Allows you to set IP options. See [IP Settings/Options Window](#) on page 115.

**HTML file manager** — Displays a list of HTML files installed on the switcher and allows you to upload custom files from a connected PC to the switcher. See [Uploading HTML files](#) on page 123.

**Hardware status** — Provides the overall status of the matrix switcher, including the primary and secondary power supply status and the individual voltages, the fan status and temperature, the rear panel Remote RS-232/RS-422 serial port configuration, and the installed and updated firmware status (see figure 74).



Green — Proper operation.  
 Red — Component has failed.  
 White — **Not displayed for the CrossPoint or MAV.**

**Figure 74. Status Window**

**NOTE:** Smaller switchers (16 x 16 matrix sizes and smaller) do not show the power supply and fan status blocks.

**Name presets** — Allows you to assign a name to each of the 32 memory presets.

**NOTES:**

- Preset names are limited to 12 upper- and lower-case alphanumeric characters.
- Certain characters are reserved for specific functions (see **Special Characters** on page 109).

**Show RS-232 strings** — Displays the RS-232 commands that are used by the current configuration. You can refer to these for SIS programming.

**I/O Group settings** — Displays the inputs/outputs groups window, which allows you to assign inputs and outputs to any one of four groups (or no group).

**Initialize** — Initializes and clears any or all of the following: ties, presets, audio configuration, preset names, icon names, and icons.

**Audio-input Configuration selection**

Audio-input-Config

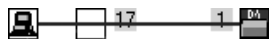
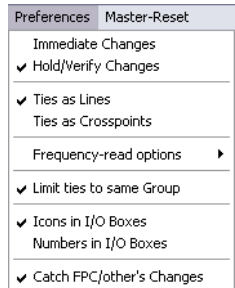
Displays the audio gain level setting for a single input or for all inputs and allows you to change it. The level is expressed as the magnitude (number of decibels) and polarity (positive, gain or negative, attenuation) of the audio adjustment.

**Preferences menu**

**Immediate changes** — Causes configuration changes to take effect immediately.

**Hold/verify changes** — Delays implementation of configuration changes until the Changes – Take button is pressed.

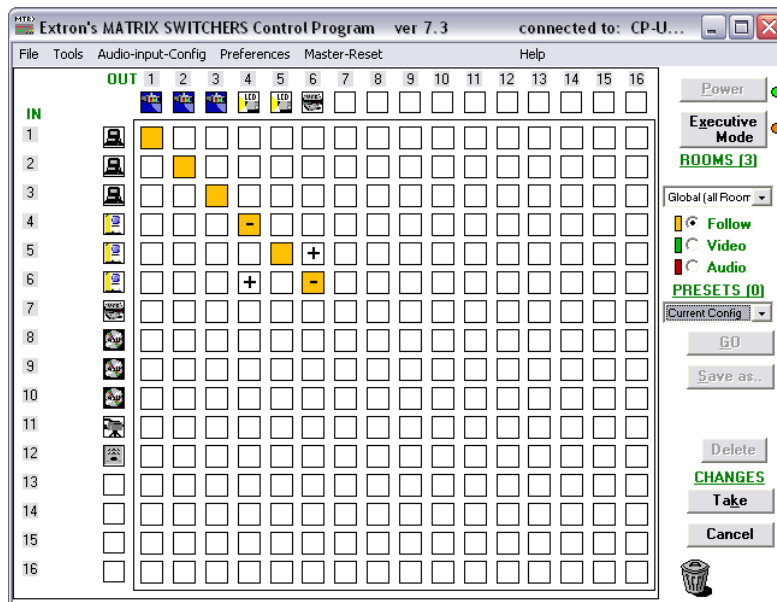
**Ties as lines** — Displays ties as lines (see figure 75).



**Figure 75. Ties Shown as Lines**

**Ties as crosspoints** — Displays ties as a grid of inputs and outputs

(see figure 76). Ties that have been made are indicated as amber (video and audio), green (video only), and red (audio only) boxes. Ties that will take effect when you click the Take button are indicated by +. Ties that will be broken when you click the Take button are indicated by -.



**Figure 76. Ties Shown as Crosspoints**

**Frequency read options (CrossPoint only)** — Allows you to set the input signal detection (DSVP) feature as follows:

- To never sample and display the sync or no sync status (set this option to **None**)
- To automatically refresh the display (set this option to **Automatically every 10 seconds**)
- To sample the sync and update the display whenever you make a configuration change (set this option to **On demand or by refresh**).

**Limit ties to same group** — Allows you to limit the creation of ties using the program to inputs and outputs that are in the same group (similar to front panel operation).



**Icons in I/O boxes** — Erases any numbers in the I/O boxes in the Control Program window (as in [figure 64](#) on page 114). You can then place icons in the boxes.



**Numbers in I/O boxes** — Erases any icons in the I/O boxes in the Control Program window and fills each box with the associated input or output number.

**Catch FPC/others changes** — When checked, sets the switcher to report all configuration and setting changes to the serial port or Ethernet connection that turned this selection on. These reports allow the Matrix Switchers Control Program to track the changes that occur in the configuration and settings of the switcher, whether commanded via the front panel, either serial port, or the Ethernet port.

## Master-Reset selection

Master-Reset

Master reset clears all ties and presets, all video and audio mutes, resets all I/O grouping, sets all input audio levels to unity gain (+0 dB), and sets all output volume levels to 100% (0 dB of attenuation).

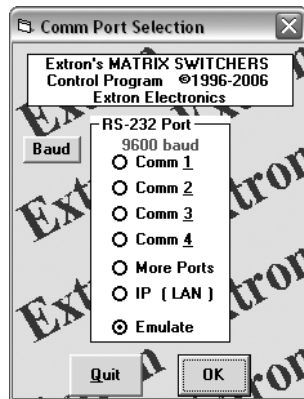
**NOTE:** Master reset does not reset the Internet protocol (IP) settings.

## Using Emulation Mode

Emulation mode allows you to set up the software without connecting the switcher. Use emulation mode as follows:

1. Click **Start > Programs > Extron Electronics > Matrix Switchers > MATRIX Switcher + Control Pgm.**

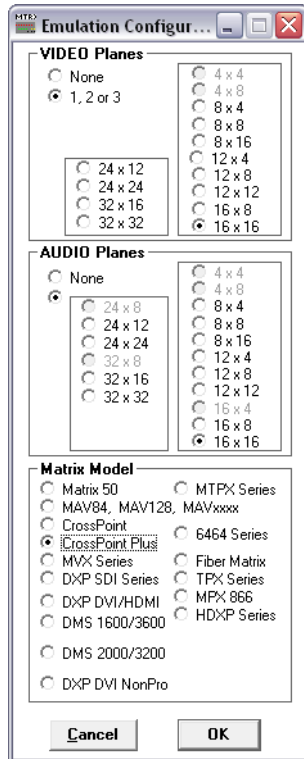
The Comm Port Selection dialog box (see [figure 77](#)) appears.



**Figure 77.** Comm Port Selection Dialog Box

2. Choose **Emulate**, and click **OK**.

3. Choose an emulation file to open, and click **OK**. The file DEMO.MTX provides a sample of a completed matrix setup. Selecting the file NEW.INI or clicking **Cancel** provides a blank setup window to get you started.
4. Enter the file name under which you want to save any changes to the file, and click **OK**.
5. See figure 78. Select the appropriate Matrix Model (**CrossPoint Plus** = 450 Plus, **CrossPoint** = Ultra, and **MAV84, MAV125, MAVxxx** = MAV Plus), the number of Video Planes and Audio Planes (or **None**), and the appropriate matrix size. Click **OK**.



**Figure 78. Emulate Configuration Dialog Box**

6. Continue using the program as described in [Using the Matrix Switcher Control Software](#), step 4 on page 113.

## Using the Help System

For information about program features, you can access the help program in any of the following ways:

- From the Extron Electronics program folder or group, double-click the MATRIX Switcher Help icon (shown at right).
- From within the Matrix Switchers Control Program, click **Help > Contents** on the menu bar.
- From within the Matrix Switchers Control Program, press the keyboard <F1> key.



## Button-Label Generator Program

The Button Label Generator software creates labels that you can place in the translucent covers of the input and output selection buttons. You can create labels with names, alphanumeric characters, or even color bitmaps for easy and intuitive input and output selection (see the [Removing and Installing Button Labels](#) on page 158 for the procedure for removing and replacing the translucent covers).

### Installing the Button Label Generator Software

The Extron Button Label Generator is available on the Extron website, [www.extron.com](http://www.extron.com), under the Download Center tab. Click the **Software** link (see figure 79), and download and install the program on your PC.



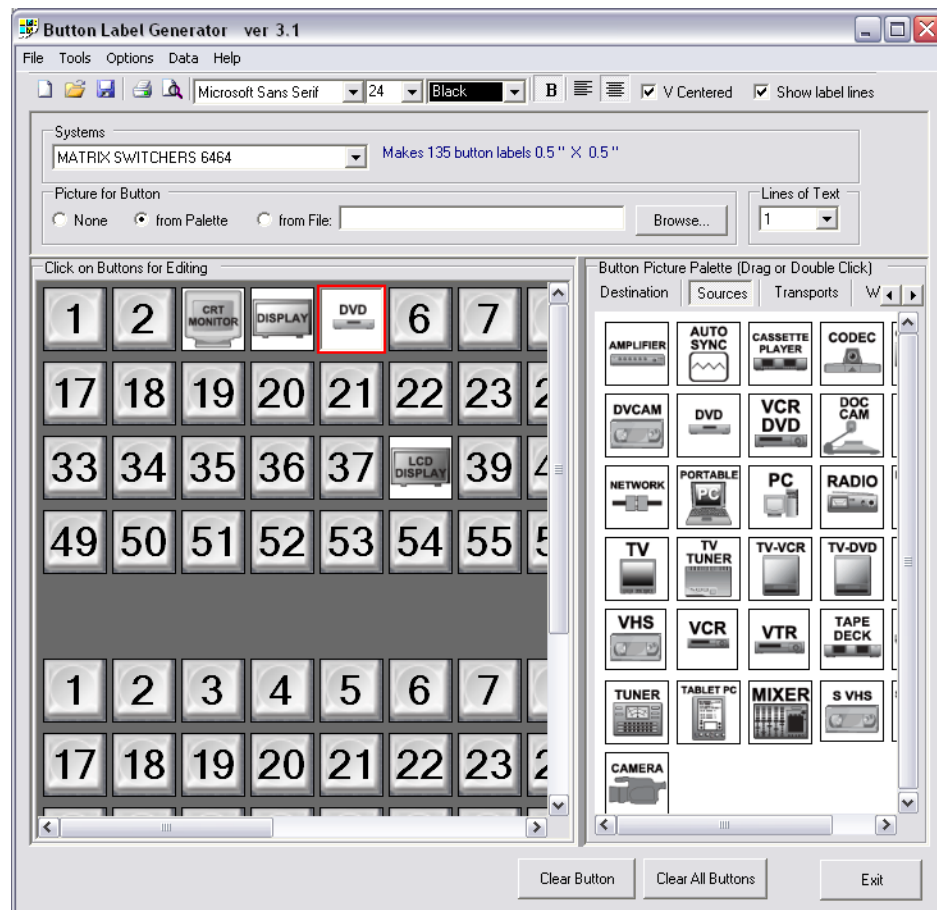
**Figure 79.** Location of Software on the Website

By default, the Windows installation creates a `C:\Program Files\Extron\ButtonLabelGenerator` directory and places the Button Label Generator icon into a group or folder named “Extron Electronics.”

**NOTE:** `C:\Program Files(x86)\ ...` for Windows 7 or Windows 8.

## Using the Button-Label Generator Software

1. To run the Button-Label Generator program, click **Start > Programs > Extron Electronics > Button Label Generator > Button Label Generator**. The Button-Label Generator window appears (see figure 80).



**Figure 80. Extron Button-Label Generator Window**

2. In the Systems selection box, choose the **Matrix Switchers 6464** option to match the button label size and quantities for your CrossPoint or MAV switcher.
3. Using normal Windows controls, you can create and print labels that can be placed in the label windows on the front panel of the switcher.

**NOTE:** For best results, print on transparent or translucent material.

4. Click the **Clear All Buttons** button and create new labels as many times as necessary to make all of the button labels that you need.

To access the help program, click **Help** on the menu bar.



# HTML Operation

The CrossPoint or MAV Plus Matrix Switcher can be remotely controlled via:

- SIS commands (see [Programming Guide](#), beginning on page 89)
- The Matrix Switchers Control Program (see [Matrix Software](#), beginning on page 110).
- Built-in HTML pages (see below)

This section introduces using the built-in HTML pages to operate the CrossPoint or MAV Plus Matrix Switchers, including:

- [Download the Startup Page](#)
- [Status Tab](#)
- [Configuration Tab](#)
- [File Management Tab](#)
- [Control Tab](#)

The switcher can be controlled and operated through its LAN port, connected via a LAN or WAN, using a web browser such as the Microsoft Internet Explorer. The display in the browser of the status or operation of the switcher has the appearance of web pages. This chapter describes the factory-installed HTML pages, which are always available and cannot be erased or overwritten.

**NOTE:** If your Ethernet connection to the matrix switcher is unstable, try turning off the proxy server in your Web browser. In Microsoft Internet Explorer, click **Tools** > **Internet Options** > **Connections** > **LAN Settings**, uncheck the **Use a proxy server...** box, and then click **OK**.

## Download the Startup Page

Access the switcher using HTML pages as follows:

1. Start the Web browser program.
2. Click in the browser **Address** field.
3. Enter the Matrix IP address in the **Address** field of the browser.

**NOTE:** If the local system administrators have not changed the value, the factory-specified default, 192.168.254.254, is the correct value for this field.

4. If you want the browser to display a page other than the default page (such as a custom page that you have uploaded), enter a slash (/) and the file name to open.

### NOTES:

- The **Address** field of the browser should display the address in the following format: `<xxx.xxx.xxx.xxx>/<optional_file_name>.html`.
- The HTML language reserves certain characters for specific functions (see [Special Characters](#) on page 109).

5. Press the keyboard <Enter> key. The switcher checks to see if it is password protected. If the switcher is not password protected, it checks and downloads the HTML pages (proceed to step 7).

If the switcher is password protected, the switcher downloads the Enter Network Password dialog box (see figure 81).



**Figure 81. Enter Network Password Dialog Box**

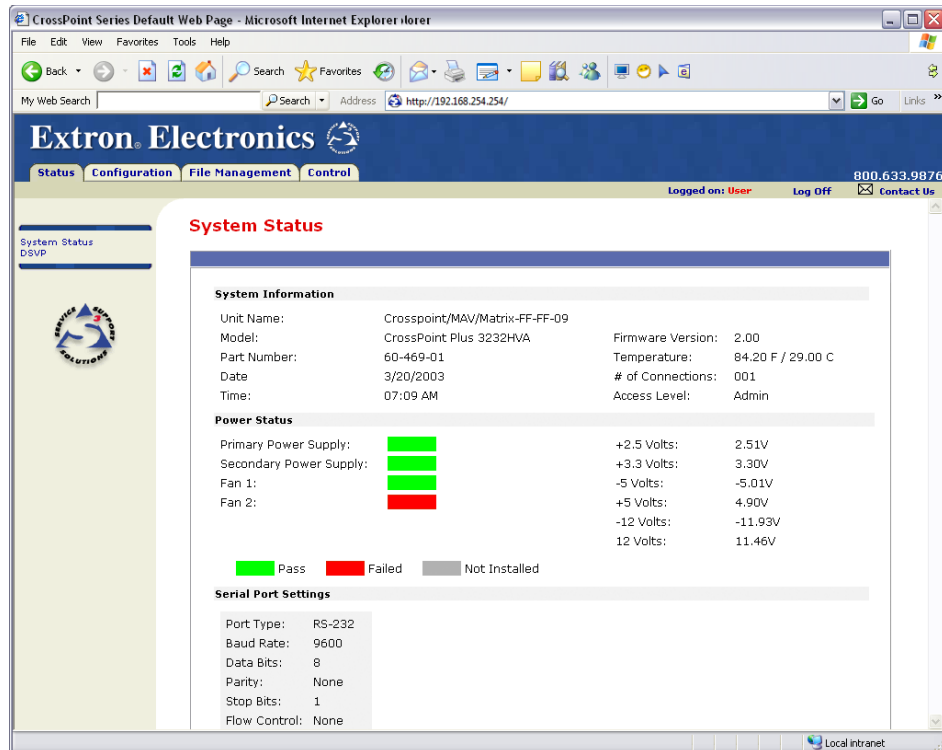
**NOTE:** A User name entry is not required.

6. Click in the **Password** field and type in the appropriate administrator or user password. Click the **OK** button.
7. The switcher checks several possibilities, in the following order, and then responds accordingly:
  - Does the address include a specific file name, such as `192.168.254.254/<file_name>.html`?  
**If so**, the switcher downloads that HTML page.
  - Is there a file in the switcher memory that is named "index.html"?  
**If so**, the switcher downloads "index.html" as the default startup page.
  - **If neither of the above conditions is true**, the switcher downloads the factory-installed default startup page, "nortxe\_index.html" (see [figure 82](#) on the next page), also known as the System Status page.

## Status Tab

### System Status Page

The System Status page (see figure 82) provides an overall view of the status of the matrix switcher, including individual voltages, fan operation, and the serial port status. The System Status page is the default page that the switcher downloads when you connect to the switcher. Access the System Status page from other pages by clicking the **Status** tab.



**Figure 82. System Status Page**

- Pass Components that are operating properly are indicated in green.
- Failed Failures are indicated in red.
- Not Installed Not displayed for the CrossPoint or MAV

**NOTE:** Smaller switchers (16 x 16 matrix sizes and smaller) do not show the power supply and fan status blocks.

The System Status web page periodically refreshes to reflect the latest status of the switcher components. If a value changes, the display shows the change in status the next time it updates.

## DSVP Page (CrossPoint Switchers)

The DSVP page (see figure 83) displays a snapshot-in-time of the input frequencies of connected inputs. Access the DSVP page from the System Status or HDCP page by clicking the **DSVP** tab. The DSVP page automatically updates itself every 30 seconds to show the latest input frequencies changes or if an input has been disconnected.

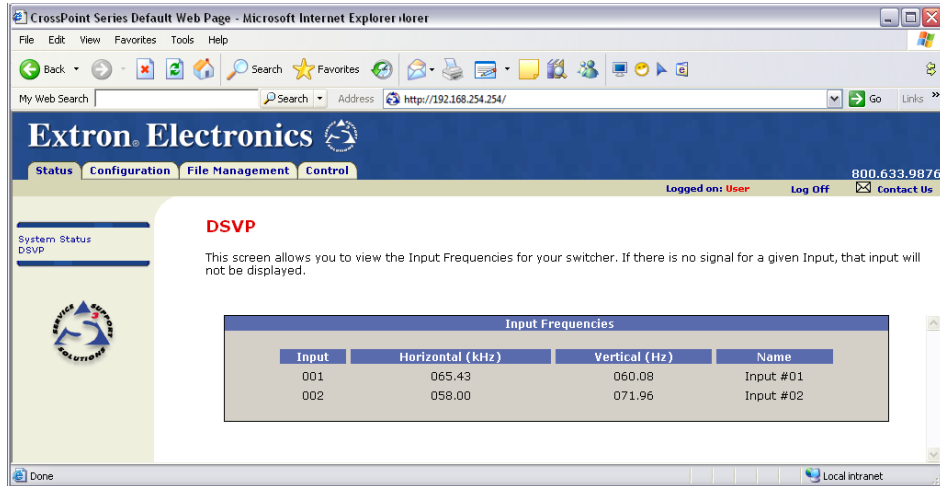


Figure 83. DSVP Page

## Configuration Tab

### System Settings Page

The CrossPoint or MAV Plus switcher downloads the System Settings page (see figure 84) when you click the **Configuration** tab. The screen consists of fields in which you can view and edit IP administration and system settings. See [Ethernet Link](#) on page 149 for basic information about IP addresses and subnetting.

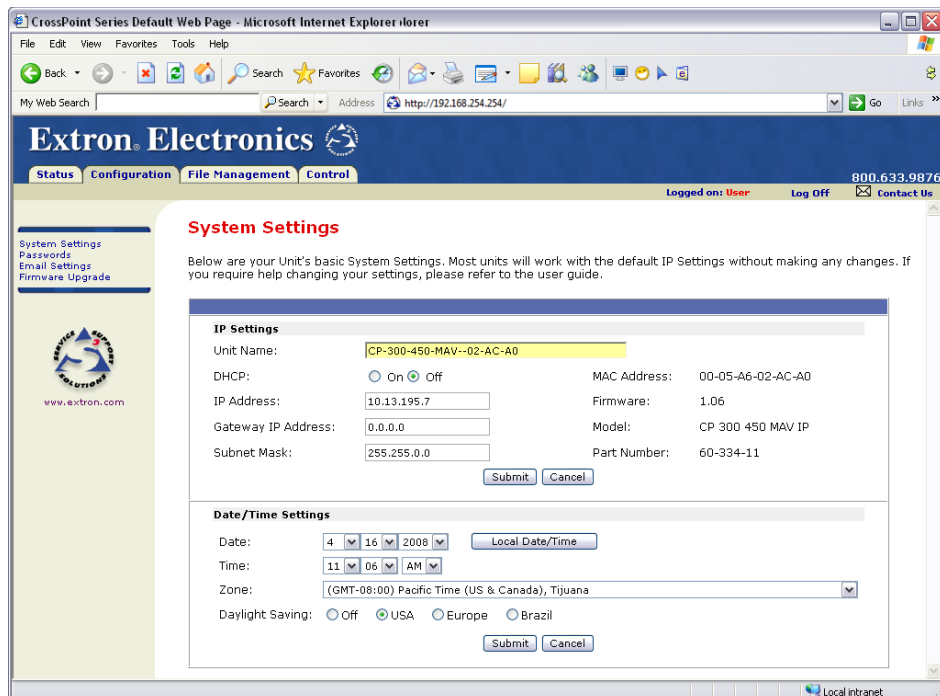


Figure 84. System Settings Page

On password-protected connections, there are two levels of protection: administrator and user. Administrators have full access to all switching capabilities and editing functions. Users can create ties, create and recall presets, set audio mutes, and view all settings with the exception of passwords.

- Ethernet connection to the switcher, either entering SIS commands (see **Programming Guide**, beginning on page 89) or using the Extron Matrix Switchers Control Program (see **Matrix Software**, beginning on page 110) is password protected.
- Connection via the RS-232/RS-422 port is not password protected.

### **IP Settings fields**

The IP Settings fields provide a location for viewing and editing settings unique to the Ethernet interface. After editing any of the settings on this page, click the **Submit** button at the bottom of the page.

#### ***Unit Name field***

The **Unit Name** field contains the name used as the “from” information when the switcher e-mails notification of its failed or repaired status. This name field can be changed to any valid name, up to 24 alphanumeric characters.

**NOTE:** The HTML language reserves certain characters for specific functions (see **Special Characters** on page 109).

#### ***DHCP radio buttons***

The **DHCP On** radio button directs the switcher to ignore any entered IP addresses and to obtain its IP address from a Dynamic Host Configuration Protocol (DHCP) server (if the network is DHCP capable). The **DHCP Off** radio button turns DHCP off. Contact the local system administrator to determine if DHCP is appropriate.

#### ***IP Address field***

The **IP Address** field contains the IP address of the connected switcher. This value is encoded in the flash memory of the switcher.

Valid IP addresses consist of four 1-, 2-, or 3-digit numeric octets separated by dots (periods). Each field can be numbered from 000 through 255. Leading zeroes, up to 3 digits total per field, are optional. Values of 256 and above are invalid.

The factory-installed default address is 192.168.254.254, but if this conflicts with other equipment at your installation, you should ask your network administrator for a new, valid address.

**NOTE:** IP address changes can cause conflicts with other equipment. Only local system administrators should change IP addresses.

#### ***Gateway IP Address field***

The **Gateway IP Address** field identifies the address of the gateway to the mail server to be used if the switcher and the mail server are not on the same subnet.

The gateway IP address has the same validity rules as the system IP address.

#### ***Subnet Mask field***

The **Subnet Mask** field is used to determine whether the switcher is on the same subnet as the mail server when you are subnetting. For more information, see **Subnetting – A Primer**, beginning on page 154.

### MAC Address field

The Media Access Control (MAC) Address is hardcoded in the switcher and cannot be changed.

### Firmware field

The **Firmware** field identifies the installed firmware version. This field is hardcoded in the switcher and cannot be changed.

### Model and Part Number fields

The **Model** and **Part Number** fields identify the switcher. These fields are hardcoded in the switcher and cannot be changed.

### Date/Time Settings fields

The Date/Time Settings fields (see figure 85) provide a location for viewing and setting the time functions.

The screenshot shows a web-based configuration interface for date and time settings. It features several input fields: 'Date' with month and day dropdowns (7 and 22), 'Time' with hour and minute dropdowns (9 and 52), and 'Zone' with a dropdown menu currently showing '(GMT-08:00)'. Below these is a 'Daylight Saving' section with radio buttons for 'Off' and 'On' (the 'On' option is selected). A year dropdown menu is open, displaying a list of years from 2000 to 2014. To the right of the form is a 'Local Date/Time' button. Below the zone dropdown, there are radio buttons for 'Europe' and 'Brazil'. At the bottom of the form are 'Submit' and 'Cancel' buttons.

**Figure 85. Date/Time Settings Fields**

To sync the switcher clock to the connected PC, simply click the **Local Date/Time** button and then click the **Submit** button.

**NOTE:** Use of the **Local Date/Time** button has no effect on the Zone and Daylight Savings Time functions.

For more complete control of the date and time settings, change the settings as follows:

1. Click the drop box for the desired value. The adjustable variables are month, day, year, hours, minutes, AM/PM, and (time) zone. A drop-down scroll box appears (the year drop box is selected in figure 85).
2. Click and drag the slider or click the scroll up ▲ button or the scroll down ▼ button until the desired value is visible.
3. Click the desired value.

#### NOTES:

- If setting the time, set the local time. The Zone variable allows you to then enter the offset from Greenwich Mean Time (GMT).
- The **Zone** field identifies the standard time zone selected and displays the amount of time, in hours and minutes, that the local time varies from the GMT international time reference.

4. Repeat steps 1 through 3 for other variables that need to be changed.

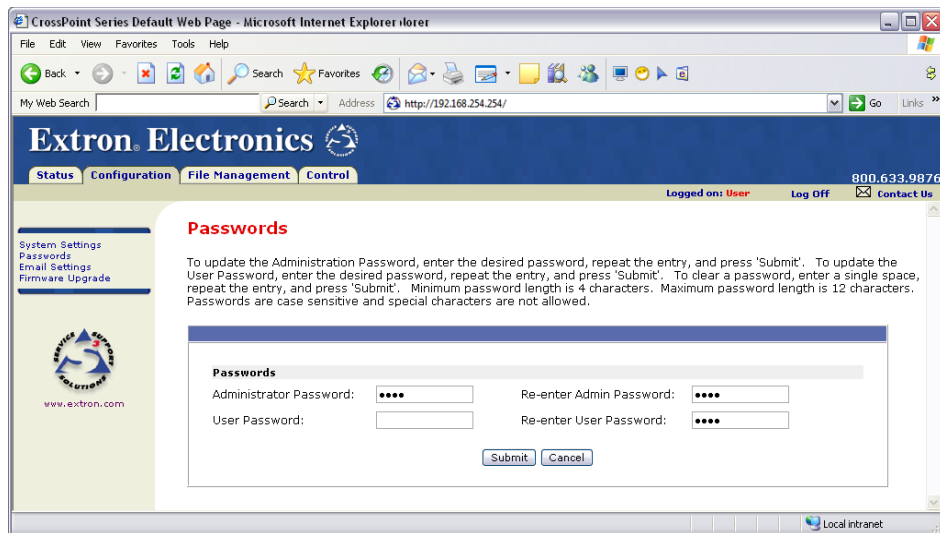
5. If appropriate, select the appropriate Daylight Savings radio button to turn on the daylight savings time feature for your region or nation.

**NOTE:** When Daylight Savings Time is turned on, the switcher automatically updates its internal clock between Standard Time and Daylight Savings Time in the spring and fall on the date that the time change occurs in the country or region selected. When Daylight Savings Time is turned off, the switcher does not adjust its time reference.

6. Click the **Submit** button.

## Passwords Page

Access the Passwords page (see figure 86) by clicking the **Passwords** link on the left of the System Settings, Email Settings, or Firmware Upgrade page.



**Figure 86. Passwords Page**

**NOTE:** If the switcher is password protected, fields on this page can be edited only by personnel logged in as administrators.

The fields on the Passwords page are for entering and verifying administrator and user passwords. Passwords are case sensitive and are limited to as many as 12 upper-case and lower-case alphanumeric characters. Each password must be entered twice; once in the **Password** field and then again in the **Re-enter Password** field. Characters in these fields are masked by asterisks (\*\*\*\*). If you do not want to password protect an access level, leave the **Password** field and the **Re-Enter Password** field blank. After entering the password in both fields, click the **Submit** button.

**NOTE:** An administrator password must be created before a user password can be created.

## Resetting a password

Reset an existing password so that no password is required as follows:

1. Clear any existing password.
2. Enter a single space character in the **Password** and **Re-enter Password** fields.
3. Click the **Submit** button.

## Email Settings Page

Reach the Email Settings page (see figure 87) by clicking the **Email Settings** link on the left of the System Settings, Passwords, or Firmware Upgrade page. The Email Settings page has fields for setting up the email notification capabilities of the switcher. For the email settings and for each row of the e-mail notification settings, click the **Edit** button to make the fields available for editing. The button changes to **Save**. After editing the settings associated with the **Edit/Save** button, click the **Save** button.

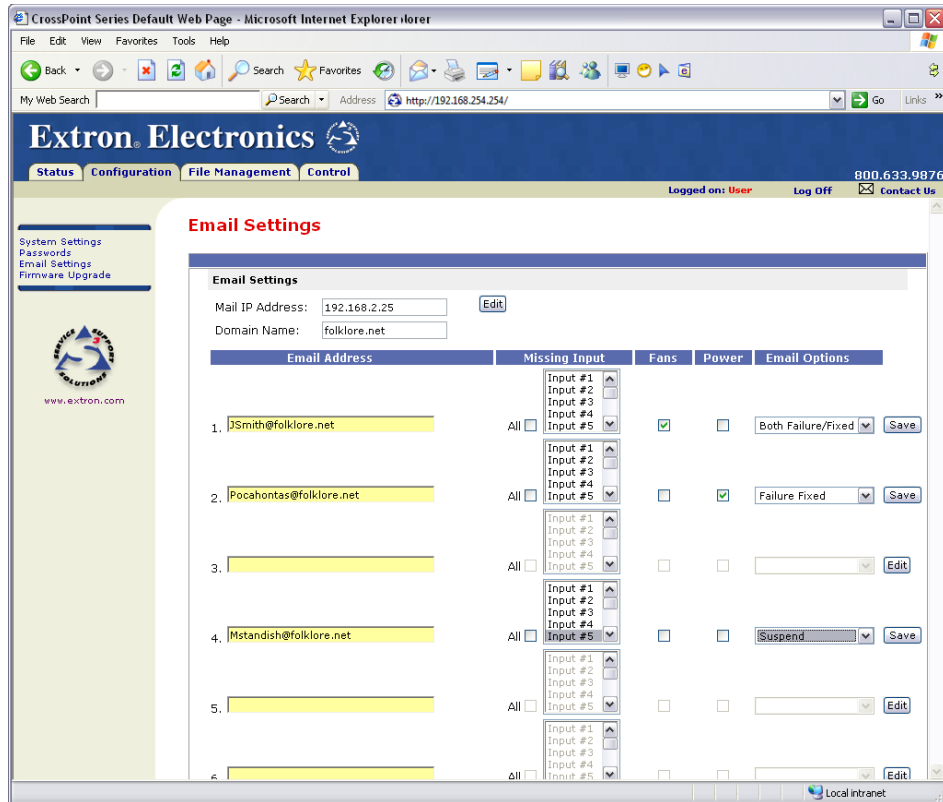


Figure 87. Email Settings Page

### Mail IP Address field

The Mail IP Address field displays the IP address and the domain name of the mail server that handles the e-mail for the facility in which the switcher is installed.

Valid IP addresses consist of four 1-, 2-, or 3-digit numeric octets separated by dots (periods). Each field can be numbered from 000 through 255. Leading zeroes, up to three digits total per field, are optional. Values of 256 and above are invalid.

### Setting up SMTP authorization

If desired, set the CrossPoint or MAV Plus to require SMTP authorization before accepting any e-mail as follows:

1. Click **Edit**. The button changes to **Save**.
2. Check the **SMTP Authorization Required** check box, located below the **Domain Name** field. This enables the **User Name** and **Password** fields below the check box.



3. Enter a user name and a password in the **User Name** and **Password** fields. For the CrossPoint or MAV Plus to accept their email messages, senders must enter the user name and password.

**NOTES:**

- For the User name, any combination of letters, numerals, spaces, and symbols except the comma (,) and the single and double quotation marks (' and ") are valid. For the password, all characters except the comma are valid. The user name and password can each be from 1 to 30 characters.
- Both a user name and a password must be specified.

4. Click **Save** to save the user name and password.

### ***Deselecting SMTP authorization***

Remove SMTP authorization as follows:

1. Click **Edit**. The button changes to **Save**.
2. Click (deselect) the **SMTP Authorization Required** check box.
3. Click **Save**.

### ***Domain Name field***

The Domain Name field displays the domain name that the CrossPoint or MAV Plus switcher uses to log on to the email server. Standard domain name conventions (for example: xxx.com) apply.

**NOTE:** The HTML language reserves certain characters for specific functions (see [Special Characters](#) on page 109). The @ character is acceptable only as the lead-in to the domain name (such as @folklore.net).

### ***Email Address fields***

The eight **Email Address** fields identify the email addresses of the personnel to whom the CrossPoint or MAV Plus switcher e-mails notification of its failure and repair status. Standard email address conventions (*nnnnn@xxx.com*) apply.

The check boxes and drop boxes associated with each address field permit the operator to specify specific criteria under which the switcher will e-mail recipients. In the associated **Missing Inputs** scroll boxes, select the inputs to monitor for presence or absence of a signal. Check the **Fans** and **Power** boxes to monitor the cooling and power supplies. In the associated **Email Options** drop box, select whether the recipient is to be e-mailed of failures, fixes, both, not notified, or to be removed from the e-mail list. The **Suspend** option is useful for temporarily removing personnel from the e-mail list when they are unavailable, such as travelling or on vacation. Deleting an e-mail addressee and clicking the **Save** button removes the recipient from email notification completely.

## Firmware Upgrade Page

The Firmware Upgrade page (see figure 88) provides another way to replace the firmware that is coded on the control board of the switcher without taking the switcher out of service. Access the Firmware Upgrade page by clicking the **Firmware Upgrade** link on the left of the System Settings, Passwords, or Email Settings page.

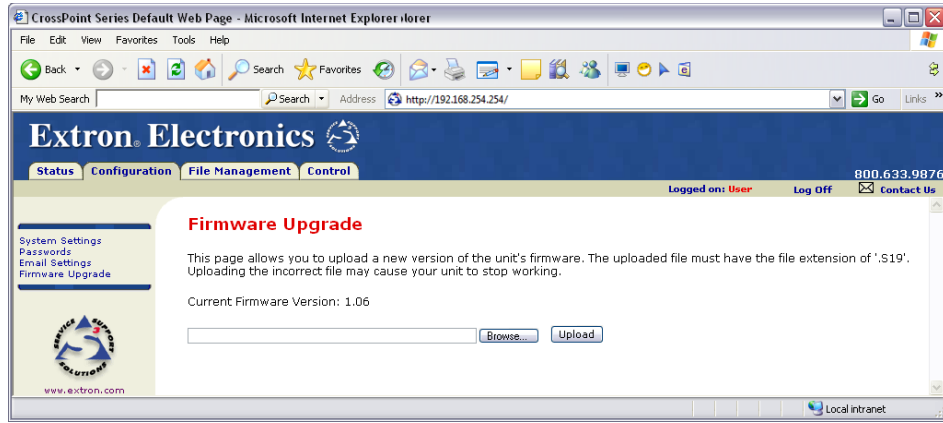


Figure 88. Firmware Upgrade Page

Update the switcher firmware as follows:

**NOTE:** The Firmware Upgrade page is **only** for replacing the firmware that controls all switcher operation. To insert your own custom HTML pages, see **File Management Page**, on page 141.

1. Perform steps 1 through 5 of **Installing the Software**, on page 111, to download the firmware upgrade from the Extron website, [www.extron.com](http://www.extron.com).
2. Connect the PC to the matrix switcher via the LAN port of the switcher.
3. Access the matrix switcher using HTML pages.
4. Click the **Configuration** tab (see figure 89).

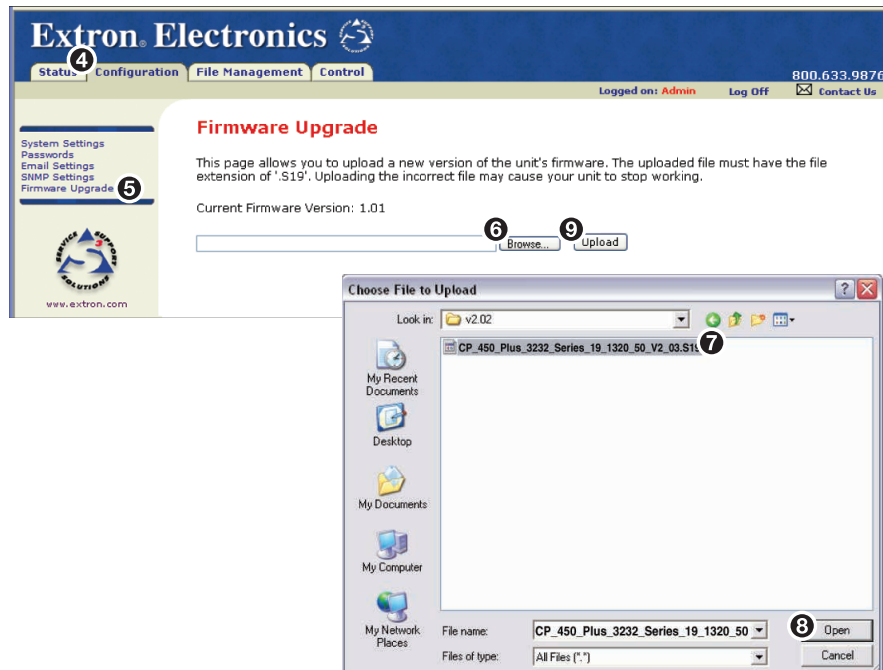


Figure 89. Firmware Upgrade

5. Click the **Firmware Upgrade** link.
6. Click the **Browse** button. A Choose File to Upload dialog box appears.
7. Navigate to the folder where you saved the firmware upgrade file. Select the file.

**ATTENTION:**

- Valid firmware files must have the file extension S19. A file with any other extension is not a firmware upgrade for this device and could cause the device to stop functioning.
- Les fichiers firmware valides doivent contenir l'extension fichier S19. Un fichier avec n'importe quelle autre extension n'est pas une mise à jour de firmware pour cet appareil et l'appareil pourrait arrêter de fonctionner.

**NOTES:**

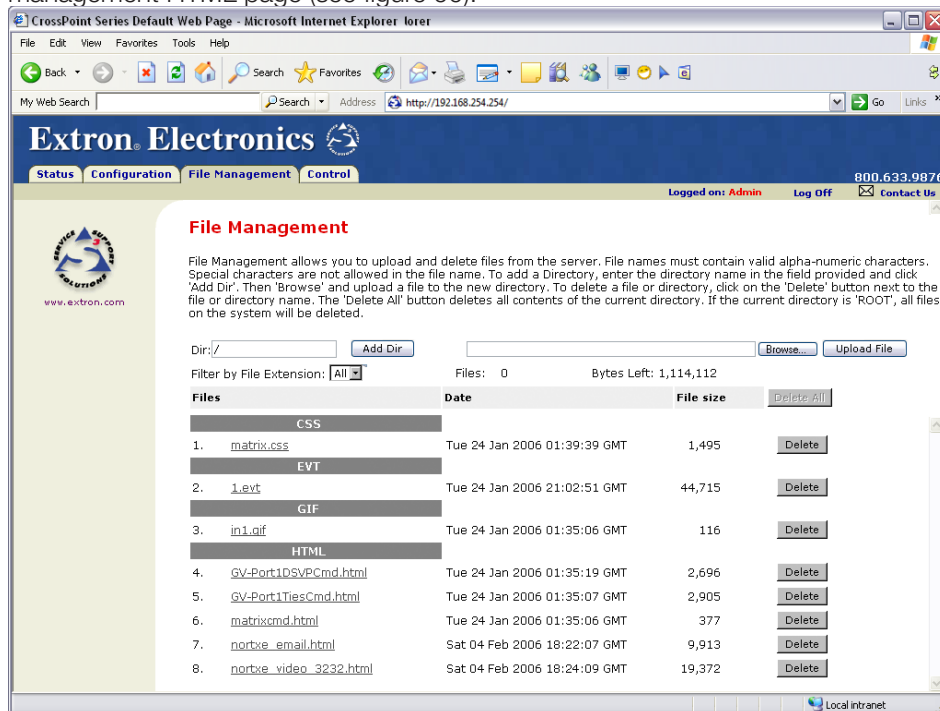
- When downloaded from the Extron website, the firmware is placed in a subfolder of:
  - **Windows 7 or Windows 8:** C:\Program Files (x86)\Extron\Firmware.
  - **Older versions:** C:\Program Files\Extron\Firmware.
- The original firmware is permanently available on the switcher. If the attempted firmware upload fails, the switcher reverts to the factory-installed firmware.

8. Click the **Open** button.
9. Click the **Upload** button. The firmware upload may take a few minutes.

## File Management Tab

### File Management Page

To delete files such as user-supplied HTML pages from the switcher or to upload your own files to the switcher, click the **File Management** tab. The switcher downloads the file management HTML page (see figure 90).



**Figure 90. File Management Page**

**NOTE:** The files listed in figure 90 are shown for example only and may not be present on your switcher.

To delete a file, click the **Delete** button associated with that file.

Upload your own files as follows:

**NOTE:** The HTML language reserves certain characters for specific functions (see **Special Characters** on page 109).

1. Click the **Browse** button.
2. Browse through your system and select the desired file of files.

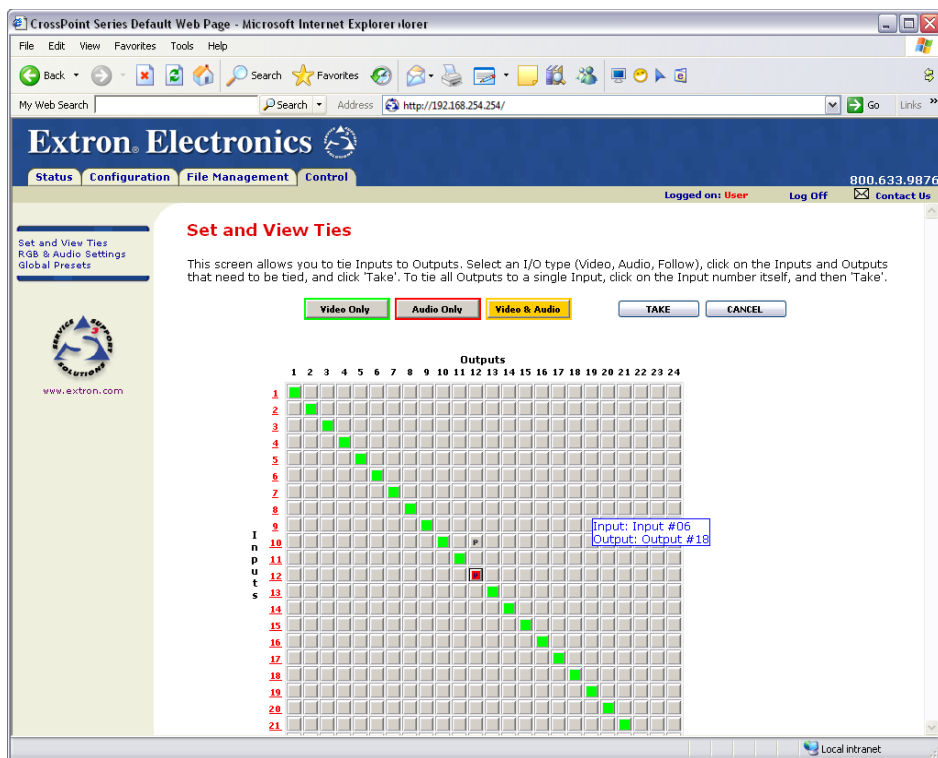
**NOTE:** If you want one of the pages that you create and upload to be the default startup page, name that file “index.html”.

3. Click the **Upload File** button. The file(s) that you selected appear in the list.

## Control Tab

### Set and View Ties Page

You can create ties on the Set and View Ties page (see figure 91). Access the Set and View Ties page by clicking the **Control** tab.



**Figure 91. User Control Ties Page**

The page consists of a matrix of input (rows) and output (columns) selection buttons of four different colors:

- The **amber** buttons indicate **video and audio ties**.
- The **green** buttons indicate **video only ties**.
- The **red** buttons indicate **audio only ties**.
- The **gray** buttons indicate **no ties**.

The page displays the input and output buttons for inputs and outputs on installed boards only.

Select and switch an input as follows:

1. Click the **Video Only**, **Audio Only**, or **Video & Audio** button to select video, audio, or both for switching (audio follow or audio breakaway). Each mouse click on a button toggles the other two buttons off.
2. Move the mouse over the matrix of input and output selection buttons. Click a button to:
  - Create a pending tie (if a tie does not exist) or pending untie (if a tie exists) of the input and output associated with that button. A “P” (for pending) appears in the button.
  - Create pending untie (if a tie exists) of the input and output associated with that button.

**NOTES:**

- If you lose track of the input and output associated with a specific button, let the mouse rest over one of the tie buttons for a moment. A field pops up (as shown on figure 91) that identifies the input and output for that button.
- To tie an input to all outputs, click that input number.

3. Click the **Take** button to make the configuration changes or the **Cancel** button to abandon the configuration changes.

## RGB and Audio Settings Page

The RGB and Audio Settings page provides a way to set the input audio gain and attenuation, set the output volume, mute and unmute all video and audio outputs, and (for CrossPoint switchers only) set the RGB delay (switching interval). Access the RGB and Audio Settings page (see figure 92) by clicking the **RGB & Audio Settings** link on the Set and View Ties page.

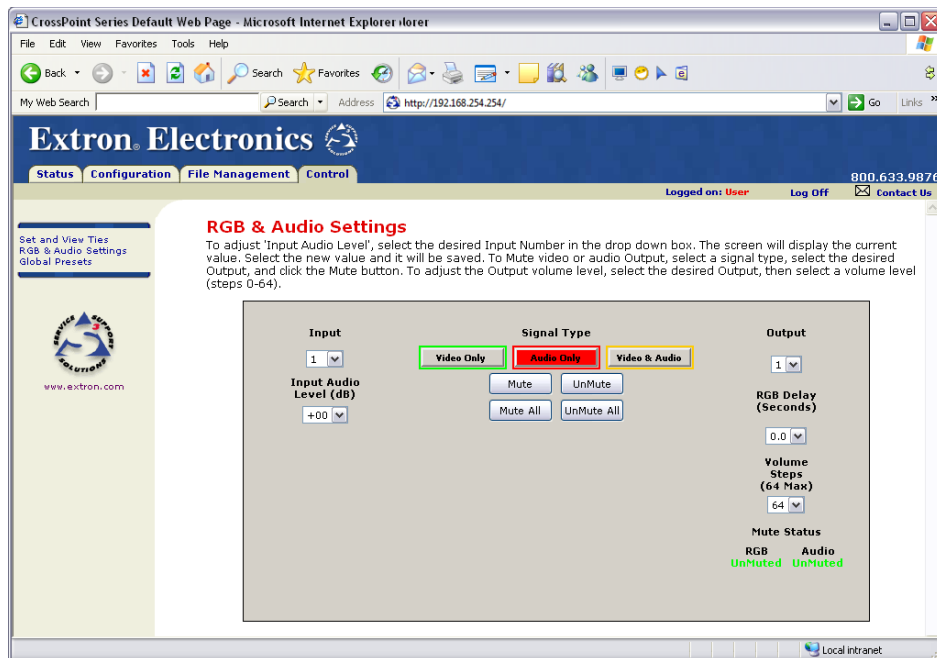


Figure 92. RGB and Audio Settings Page

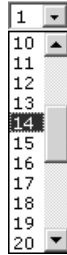
## Change the input gain and attenuation (audio models)

Users can set the level of audio gain or attenuation of each input (-18 dB to +24 dB) from the RGB and Audio Settings page. Audio levels can be adjusted so there are no noticeable volume differences between sources.

Change the audio level setting of an input as follows:

1. Click the **Input** drop box. A drop down scroll box appears (see figure 93).

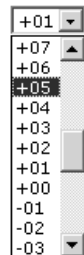
### Input



**Figure 93. Input Selection Drop Box**

2. Click and drag the slider or click on the scroll up ▲ button or scroll down ▼ button until the desired input is visible.
3. Click the desired input.
4. Click the **Input Audio Level (dB)** drop box. A drop down scroll box appears (see figure 94).

### Input Audio Level (dB)



**Figure 94. Gain Drop Box**

5. Click and drag the slider or click on the scroll up ▲ button or scroll down ▼ button until the desired input is visible.
6. Click the desired gain or attenuation value.

## Mute and unmute one or all outputs

Mute one or all outputs as follows:

1. To select an individual output to mute or unmute, click the **Output** drop box. A drop down scroll box appears (see figure 95).

**Output**



**Figure 95. Output Selection Drop Box**

2. Click and drag the slider or click the scroll up ▲ button or scroll down ▼ button until the desired output is visible.
3. Click the desired output.
4. Click the **Video Only**, **Audio Only**, or **Video & Audio** button to select video, audio, or both for muting. Each mouse click on a button toggles the other two buttons off.
5. Click the **Mute** or **UnMute** button to mute or unmute the selected output.
6. Click the **Mute All** or **UnMute All** to mute or unmute all of the outputs.

Observe the Mute status indications on the page.

Unmuted is displayed in green and Muted is displayed in red.

Mute Status	
RGB	Audio
UnMuted	Muted

## Change the RGB delay (CrossPoint switchers)

The RGB delay interval defines how long the screen is blanked when switching to a new input for the selected output.

Change the RGB delay as follows:

1. Click the **Output** drop box. A drop down scroll box appears (see figure 96).

**Output**

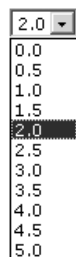


**Figure 96. Output Selection Drop Box**

2. Click and drag the slider or click on the scroll up ▲ button or scroll down ▼ button until the desired output is visible.
3. Click the desired output.

- Click the **RGB delay** Drop box. A drop down scroll box appears (see figure 97).

**RGB Delay  
(Seconds)**



**Figure 97. RGB Delay Drop Box**

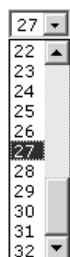
- Click the desired RGB delay.

### Change the output volume level (audio models)



Change the volume level of an output as follows:

- Click the **Output** drop box. A drop down scroll box appears (see figure 98).

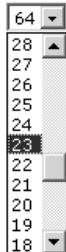
**Output**



**Figure 98. Output Selection Drop Box**

- Click and drag the slider or click the scroll up  button or scroll down  button until the desired output is visible.
- Click the desired output.
- Click the **Volume Steps** drop box. A drop down scroll box appears (see figure 99).



**Volume  
Steps  
(64 Max)**



**Figure 99. Volume Drop Box**

- Click the desired output volume step value.

#### **NOTES:**

- As an alternative to steps 4 and 5, or to listen to the audio as you make adjustments, click on the up  button or down  button.
- Table 7**, on the next page, defines the value of each audio volume step.



**Table 7. Audio Volume Adjustment Settings**

Number of steps	dB of attenuation	Output volume	Number of steps	dB of attenuation	Output volume	Number of steps	dB of attenuation	Output volume
00	76	0%						
01	63	5.5%	23	41	38.5%	45	19	71.5%
02	62	7%	24	40	40%	46	18	73%
03	61	8.5%	25	39	41.5%	47	17	74.5%
04	60	10%	26	38	43%	48	16	76%
05	59	11.5%	27	37	44.5%	49	15	77.5%
06	58	13%	28	36	46%	50	14	79%
07	57	14.5%	29	35	47.5%	51	13	80.5%
08	56	16%	30	34	49%	52	12	82%
09	55	17.5%	31	33	50.5%	53	11	83.5%
10	54	19%	32	32	52%	54	10	85%
11	53	20.5%	33	31	53.5%	55	9	86.5%
12	52	22%	34	30	55%	56	8	88%
13	51	23.5%	35	29	56.5%	57	7	89.5%
14	50	25%	36	28	58%	58	6	91%
15	49	26.5%	37	27	59.5%	59	5	92.5%
16	48	28%	38	26	61%	60	4	94%
17	47	29.5%	39	25	62.5%	61	3	95.5%
18	46	31%	40	24	64%	62	2	97%
19	45	32.5%	41	23	65.5%	63	1	98.5%
20	44	34%	42	22	67%	64	0	100%
21	43	35.5%	43	21	68.5%			
22	42	37%	44	20	70%			

## Global Presets Page

You can save and recall global presets from the Global Presets page (see figure 100). Access the Global presets page by clicking the **Global Presets** link on the left of the Set and View Ties or RGB & Audio Settings page.

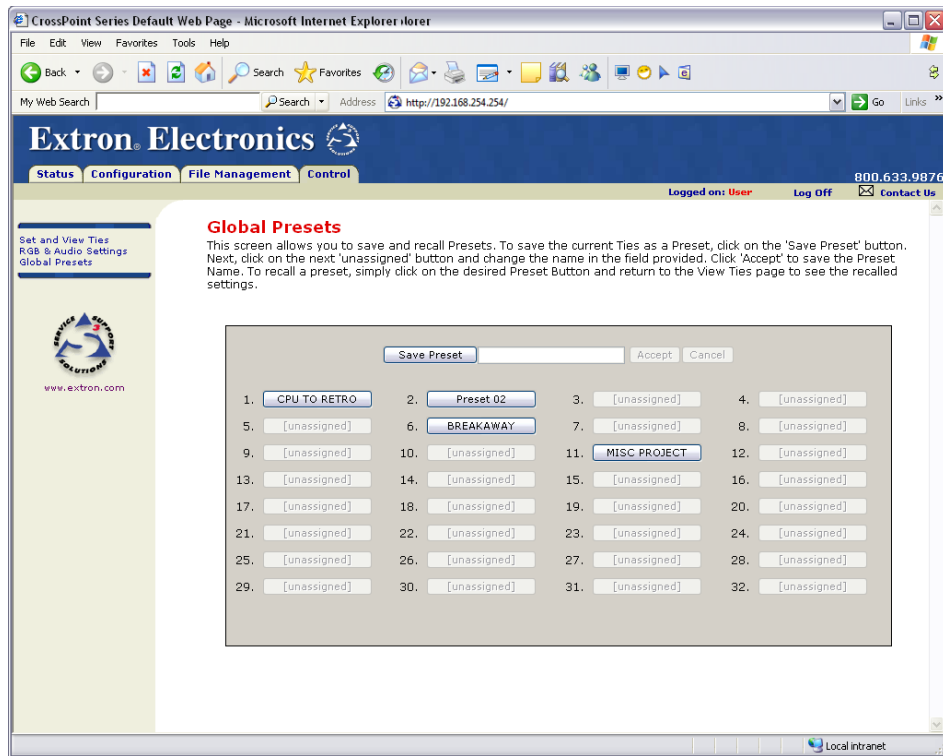


Figure 100. Global Presets Page

### Saving a preset

Save the current configuration (configuration 0) as a preset as follows:

1. Click the **Save Preset** button.
2. Select the desired preset by clicking on one of the presets listed. To create a new preset, click one of the **[unassigned]** buttons. Overwrite an existing preset by clicking an already existing preset.
3. If desired, type over the current name in the box adjacent to the **Save Preset** button.

**NOTE:** The HTML language reserves certain characters for specific functions (see **Special Characters** on page 109).

If you do not rename an unassigned button, the CrossPoint or MAV Plus switcher names the preset as Preset {next available number}.

If you do not rename an existing preset when it is overwritten, the CrossPoint or MAV Plus switcher retains the same name.

4. Click the **Accept** button.

### Recalling a preset

To recall a global preset as the current configuration, click the button associated with the desired preset.

# Ethernet Connection

This section provides a high level discussion of the Ethernet connection to the switcher and a primer on the subject of subnetting. Topics that are covered, include:

- [Ethernet Link](#)
- [Subnetting – A Primer](#)

## Ethernet Link

The rear panel Ethernet connector on the CrossPoint or MAV Plus switcher can be connected to an Ethernet LAN or WAN. This connection makes SIS control of the switcher possible using a computer connected to the same LAN.

## Ethernet Connection

The Ethernet cable can be terminated as a straight-through cable or a crossover cable and must be properly terminated for your application (see figure 101).

- **Crossover cable** — Direct connection between the computer and the CrossPoint or MAV Plus switcher
- **Patch (straight-through) cable** — Connection of the CrossPoint or MAV Plus switcher to an Ethernet LAN

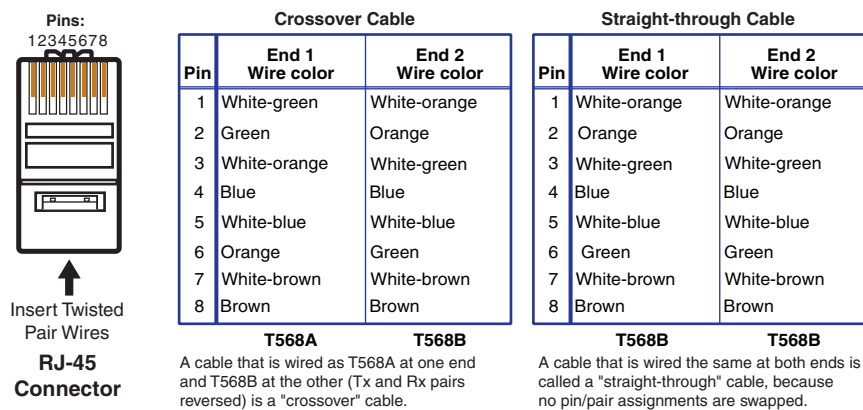


Figure 101. RJ-45 Connector Pinout Tables

## Default IP Address

To access the CrossPoint or MAV Plus switcher via the LAN port, you need the IP address of the switcher. If the address has been changed to an address comprised of words and characters, you can determine the actual numeric IP address using the ping utility. If the address has not been changed, the factory-specified default is 192.168.254.254.

Ping can also be used to test the Ethernet link to the CrossPoint or MAV Plus switcher.

## Pinging to Determine the Extron IP Address

The ping utility is available at the Command prompt. Ping tests the Ethernet interface between the computer and the CrossPoint or MAV Plus switcher. Ping can also be used to determine the actual numeric IP address from an alias and to determine the web address.

Ping the switcher as follows:

1. On the Windows task bar, click on **Start > Run**.
2. At the **Open** prompt, type **command**.
3. Click the **OK** button.
4. At the Command prompt, type **ping {IP address}** and then press <Enter>. The computer returns a display similar to the one shown in figure 102.

```
C:\>ping 192.168.254.254

Pinging 192.168.254.254 with 32 bytes of data:

Reply from 192.168.254.254: bytes=32 time<10ms TTL=128
Reply from 192.168.254.254: bytes=32 time<10ms TTL=128
Reply from 192.168.254.254: bytes=32 time<10ms TTL=128
Reply from 192.168.254.254: bytes=32 time<10ms TTL=128

Ping statistics for 192.168.254.254:
    Packets: Sent = 4, Received = 4, Lost = 0 (0% loss),
    Approximate round trip times in milli-seconds:
        Minimum = 0ms, Maximum = 0ms, Average = 0ms
```

**Figure 102. Typical Ping Response**

The line **Pinging ...** reports the actual numeric IP address, regardless of whether you entered the actual numeric IP address or an alias name.

## Pinging to Determine the Web IP Address

The ping utility has a modifier, **-a**, that directs the command to return the web address rather than the numeric IP address.

At the Command prompt, type **ping -a {IP address}** and then press <Enter>. The return display is similar to the ping response shown in figure 102, except that when you specify the **-a** modifier, the line **Pinging mail...** reports the web IP address rather than the numeric IP address, regardless of whether you entered the actual numeric IP address or an alias name.

## Configuring the CrossPoint or MAV Plus Switcher for Network Use via the ARP Command

The ARP (address resolution protocol) command tells your computer to associate the MAC (media access control) address of the CrossPoint or MAV Plus switcher with the assigned IP address. You must then use the ping utility to access the controller, at which point the IP address of the controller is reconfigured.

Use ARP to configure the IP address as follows:

1. Obtain a valid IP address for the CrossPoint or MAV Plus switcher from your network administrator.
2. Obtain the MAC address (UID #) of the CrossPoint or MAV Plus switcher from the label on its rear panel. The MAC address should have this format: 00-05-A6-xx-xx-xx.
3. If the CrossPoint or MAV Plus switcher has never been configured and is still set for factory defaults, proceed to step 4. If not, perform a mode 4 system reset and then proceed to step 4. For detailed information on reset modes, see **Performing Soft System Resets (Resets 3, 4, and 5)** on page 80.

**NOTE:** The CrossPoint or MAV Plus switcher must be configured with the factory default IP address (192.168.254.254) before the ARP command is executed, as described below.

4. At the PC, access the Command prompt (see **Pinging to Determine the Extron IP Address** on the preceding page, steps 1 through 3), then enter the **arp -s** command. Type in the desired new IP address for the unit (obtained in step 1) and the MAC address of the unit (from the rear panel of the unit), for example **arp -s 10.13.197.7 00-05-A6-03-69-B0** and then press <Enter>.

The computer returns the command prompt (C:\).

After you issue the **arp -s** command, the controller changes to the new address and starts responding to the ping requests to the new address, as described in the next step.

**NOTE:** You must ping the switcher for the IP address change to take place. The response should show the new IP address, as shown in figure 103.

5. Execute a ping command by entering ping followed by a space and the new IP address at the command prompt. For example:

**ping 10.13.197.7**

```
C:\>ping 10.13.197.7

Pinging 10.13.197.7 with 32 bytes of data:

Reply from 10.13.197.7: bytes=32 time<10ms TTL=128
Reply from 10.13.197.7: bytes=32 time<10ms TTL=128
Reply from 10.13.197.7: bytes=32 time<10ms TTL=128
Reply from 10.13.197.7: bytes=32 time<10ms TTL=128

Ping statistics for 10.13.197.7:
    Packets: Sent = 4, Received = 4, Lost = 0 (0% loss),
    Approximate round trip times in milli-seconds:
        Minimum = 0ms, Maximum = 0ms, Average = 0ms
```

**Figure 103. Ping with New Address**

**TIP:** You can reconnect using either Telnet or a web browser to verify that the update was successful.

6. After verifying that the IP address change was successful, enter and issue the `arp -d` command at the Command prompt. For example:

**arp -d 10.13.197.7** removes 10.13.197.7 from the ARP table

or

**arp -d\*** removes all static IP addresses from the ARP table.

## Connecting as a Telnet Client

The Microsoft Telnet utility is available from the Command prompt. Telnet allows you to input SIS commands to the CrossPoint or MAV Plus switcher from the PC via the Ethernet link and the LAN.

Access the Command prompt and start Telnet as follows:

1. On the Windows task bar, click **Start > Run**.
2. At the **Open** prompt, type **command**.
3. Click the **OK** button.
4. At the Command prompt, type **Telnet** and then press <Enter>. The computer returns a display similar to the one shown in figure 104.

```
Microsoft (R) windows 2000 (TM) Version 5.0 (Build 2195)
Welcome to Microsoft Telnet Client
Telnet Client Build 5.00.99203.1

Escape Character is 'CTRL+]'

Microsoft Telnet>
```

**Figure 104. Telnet Window**

## Telnet Tips

It is not the intention of this guide to detail all of the operations and functionality of Telnet; however, some basic level of understanding is necessary for operating the CrossPoint or MAV Plus switcher via Telnet.

### Open

Connect to the CrossPoint or MAV Plus switcher using the Open command. Once you are connected to the switcher, you can enter the SIS commands the same as you would if you were using the RS-232 or RS-422 link.

Connect to the CrossPoint or MAV Plus switcher as follows:

1. At the Telnet prompt, type **open {IP address}** and then press <Enter>.

**If the switcher is not password protected**, no further prompts are displayed until you break or disconnect the connection to the matrix switcher.

**If the switcher is password protected**, Telnet displays the password prompt.

2. If necessary, at the password prompt, type the appropriate password and then press <Enter>.

Connection to the switcher via the Ethernet can be password protected. There are two levels of password protection: administrator and user. A person logged on as an administrator has full access to all matrix switcher switching capabilities and editing functions. Users can create ties, set mutes, and view all settings with the exception of passwords. By default, the CrossPoint or MAV Plus switcher is shipped with both passwords set to {*carriage return*}.

Once you are logged in, the switcher returns either `Login Administrator` Or `Login User`. No further prompts are displayed until you break or disconnect the connection to the CrossPoint or MAV Plus switcher.

## Escape character and Esc key

When Telnet is first started, the utility advises that the Escape character is 'ctrl+j'. Many SIS commands include the keyboard <Esc> key. Consequently, some confusion may exist between the Escape character and the Escape key.

The Telnet Escape character is a key combination, the <Ctrl> key and the <j> key pressed simultaneously, which returns you to the Telnet prompt while leaving the connection to the CrossPoint or MAV Plus switcher intact.

The Escape key is the <Esc> key on the computer keyboard.

## Analog echo

Once connected to the CrossPoint or MAV Plus switcher, by default, Telnet does not display your keystrokes on the screen. SIS commands are typed in blindly and only the SIS responses are displayed on the screen. To command Telnet to show keystrokes, at the Telnet prompt, type **set analog\_echo** and then press <Enter> before you open the connection to the switcher.

With analog echo turned on, keystrokes and the responses of the switcher are displayed on the same line. For example: `1*1!In1 out1 A11`, where `1*1!` is the SIS command and `In1 out1 A11` is the response.

With analog echo turned on, all keystrokes are displayed, even those that should be masked, such as the password entry. For example, when entering a password with analog echo turned on, you see a display such as `a*d*m*i*n*`, where **admin** is the keyed in password and `*****` is the masked response.

You can turn off analog echo by typing **unset analog\_echo** and then pressing <Enter> at the Telnet prompt. If you are connected to the CrossPoint or MAV Plus switcher and need to access the Telnet prompt to turn analog echo off, type the Escape character (<Ctrl>+<j>).

## Set carriage return-line feed

Unless commanded otherwise, Telnet transmits a line feed character only (no carriage return) to the connected switcher when you press the <Enter> key. This is the correct setting for SIS communication with the switcher. The Telnet **set crlf** command forces Telnet to transmit carriage return and line feed characters when <Enter> is pressed, but if `crlf` is set, the SIS link with the switcher does not function properly.

## Close

To close the link to the switcher, access the Telnet prompt by typing the Escape character (<Ctrl>+<j>). At the Telnet prompt, type `close`, and then press <Enter>.

## Help

For Telnet command definitions, at the Telnet prompt, type `?` and then press <Enter>.





## Subnet Masks and Octets

The subnet mask (see figure 106) is used to determine whether the analog and remote devices are on the same subnet or different subnets. The subnet mask consists of four numeric octets separated by dots. Each octet can be numbered from 000 through 255. Leading zeroes, up to three digits total per octet, are optional. Each octet typically contains either 255 or 0. The octets determine whether or not the same octets of two IP addresses will be compared when determining if two devices are on the same subnet.

255 indicates that this octet will be compared between two IP addresses. 0 indicates that this octet will **not** be compared between two IP addresses.

Typical Subnet Mask: 255.255.0.0  
Octets

**Figure 106. Typical Subnet Mask**

## Determining Whether Devices Are on the Same Subnet

To determine the subnet, the IP address of the analog device is compared to the IP address of the remote device (see figure 107). The octets of each address are compared or not compared, depending on the value in the related subnet mask octet.

- If a subnet mask octet contains the value 255, the related octets of the IP addresses of the analog device and the remote device are unmasked.

**Unmasked octets are compared** (indicated by ? in figure 107).

- If the subnet mask octet contains the value 0, the related octets of the IP addresses of the analog device and remote device are masked.

**Masked octets are not compared** (indicated by X in figure 107).

If the unmasked octets of the two IP addresses **match** (indicated by = in figure 107, example 1), the two addresses **are on the same subnet**.

If the two unmasked fields **do not match** (indicated by ≠ in figure 107, example 2 and example 3), the addresses **are not on the same subnet**.

	Example 1	Example 2	Example 3
Local IP Address:	192.168.254.254	192.168.254.254	192.168.254.254
Subnet Mask:	255.255.0.0 (?.?.X.X)	255.255.0.0 (?.?.X.X)	255.255.0.0 (?.?.X.X)
Remote IP Address:	<u>192.168.2.25</u>	<u>190.190.2.25</u>	<u>192.190.2.25</u>
Match?:	<u>=.?.X.X — Match</u> (Same subnet)	<u>≠.?.X.X — No match</u> (Different subnet)	<u>≠.?.X.X — No match</u> (Different subnet)

**Figure 107. Comparing the IP Addresses of the Analog and Remote Devices**

# Reference Information

This section provides reference information for the CrossPoint or MAV Plus matrix switchers, including:

- **Mounting the Switcher**
- **Removing and Installing Button Labels**

**ATTENTION:**

- Installation and service must be performed by authorized personnel only.
- L'installation et l'entretien doivent être effectués par le personnel autorisé uniquement.

## Mounting the Switcher

The matrix switchers are housed in rack-mountable, metal enclosures with 19" rack ears. The amount of vertical rack space required for each switcher is as follows:

- 2U high enclosure
  - MAV Plus 84, 88, 124, and 128 HDA and HD
  - MAV Plus 84, 88, 124, 128, and 1212 SVA, and SV
  - MAV Plus 84, 88, 124, 128, 816, 1212, 168, and 1616 AV, AV RCA, V, and A
  - MAV Plus 164 A
- 3U high enclosure
  - CrossPoint 84, 88, and 128 HV and HVA
  - MAV Plus 168, 816, 1212, and 1616 SVA and SV
  - MAV Plus 328 and 248 A switchers
- 4U high enclosure
  - MAV Plus 168, 816, and 1616 HDA and HD
- 5U high enclosure
  - MAV Plus 2412, 2424, 3216, 3232 AV, V, and A
- 6U high enclosure
  - CrossPoint 168, 1212, and 1616 HV and HVA
- 8U high enclosure
  - CrossPoint 450 Plus 2412 and 2424 HV and HVA
- 10U high enclosure
  - CrossPoint 450 Plus 3216 and 3232 HV and HVA

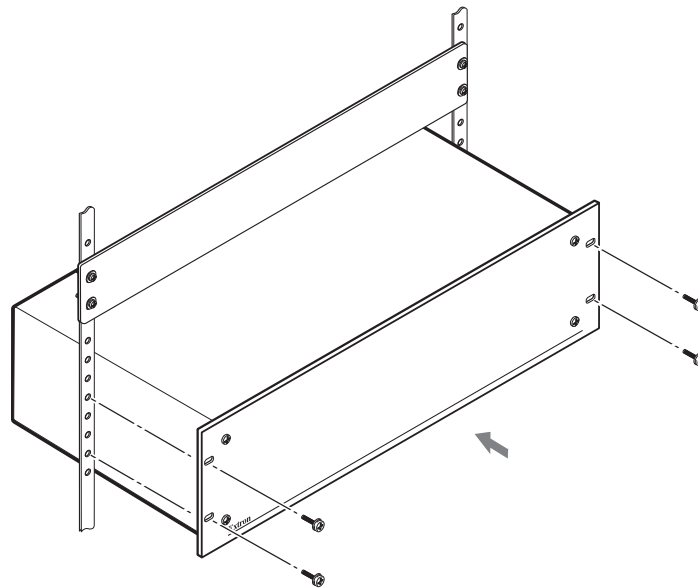
## UL Guidelines

The following Underwriters Laboratories (UL) guidelines pertain to the installation of the matrix switcher into a rack.

- **Elevated operating ambient temperature** — If installed in a closed or multi-unit rack assembly, the operating ambient temperature of the rack environment may be greater than room ambient. Therefore, consider installing the equipment in an environment compatible with the maximum 122 °F (50 °C) (CrossPoint) or 113 °F (45 °C) (MAV Plus) ambient temperature (T<sub>ma</sub>) specified by Extron.
- **Reduced air flow** — Installation of the equipment in a rack should be such that the amount of air flow required for safe operation of the equipment is not compromised.
- **Mechanical loading** — Mounting of the equipment in the rack should be such that a hazardous condition is not achieved due to uneven mechanical loading.
- **Circuit overloading** — Consideration should be given to the connection of the equipment to the supply circuit and the effect that overloading of the circuits might have on overcurrent protection and supply wiring. Appropriate consideration of equipment nameplate ratings should be used when addressing this concern.
- **Reliable earthing (grounding)** — Reliable earthing of rack-mounted equipment should be maintained. Particular attention should be given to supply connections other than direct connections to the branch circuit (such as the use of power strips).

## Mounting Instructions

1. Insert the unit into the rack, aligning the mounting bracket holes with those in the rack (see figure 108).
2. Secure the switcher to the rack using the supplied bolts.



**Figure 108.** Installing the Switcher in a Rack

## Removing and Installing Button Labels

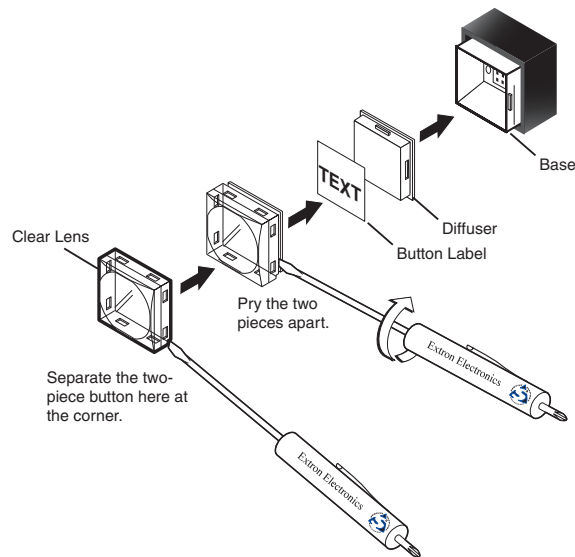
### Making Labels from Paper Templates

**Figure 110** on page 159 provides strips of blank button labels. If desired, copy them or cut them out, write button information in each button area as desired, and put them in the windows of the input or output buttons.

### Installing Labels in the Buttons

Install new labels in the front panel buttons as follows:

1. Remove the button from the matrix switcher; use a small, flat bladed screwdriver such as an Extron Tweaker to gently pry a button out from the front panel (see figure 109).



**Figure 109. Illuminated Button Label Replacement**

2. Locate the notch in the corner of one side of the clear button cap lens.
3. Separate the white backing (diffuser) from the clear button cap (lens); insert the blade of the small screwdriver into the corner notch and gently twist the blade.
4. Save the translucent, white diffuser, but remove the text/label insert from the transparent button cap lens.
5. Insert the replacement button label into the button cap. Check for correct label orientation.
6. Align the white diffuser plate with the cap (lens). The bumps on the diffuser plate should be aligned (top and bottom) with the notches on the clear button cap. Firmly snap it into place.
7. Align the tabs on the base of the matrix switcher with the notches on the diffuser plate. Gently, but firmly, press the reassembled button into place in the front panel of the switcher.
8. Repeat steps 1 to 7 as needed to relabel other buttons.

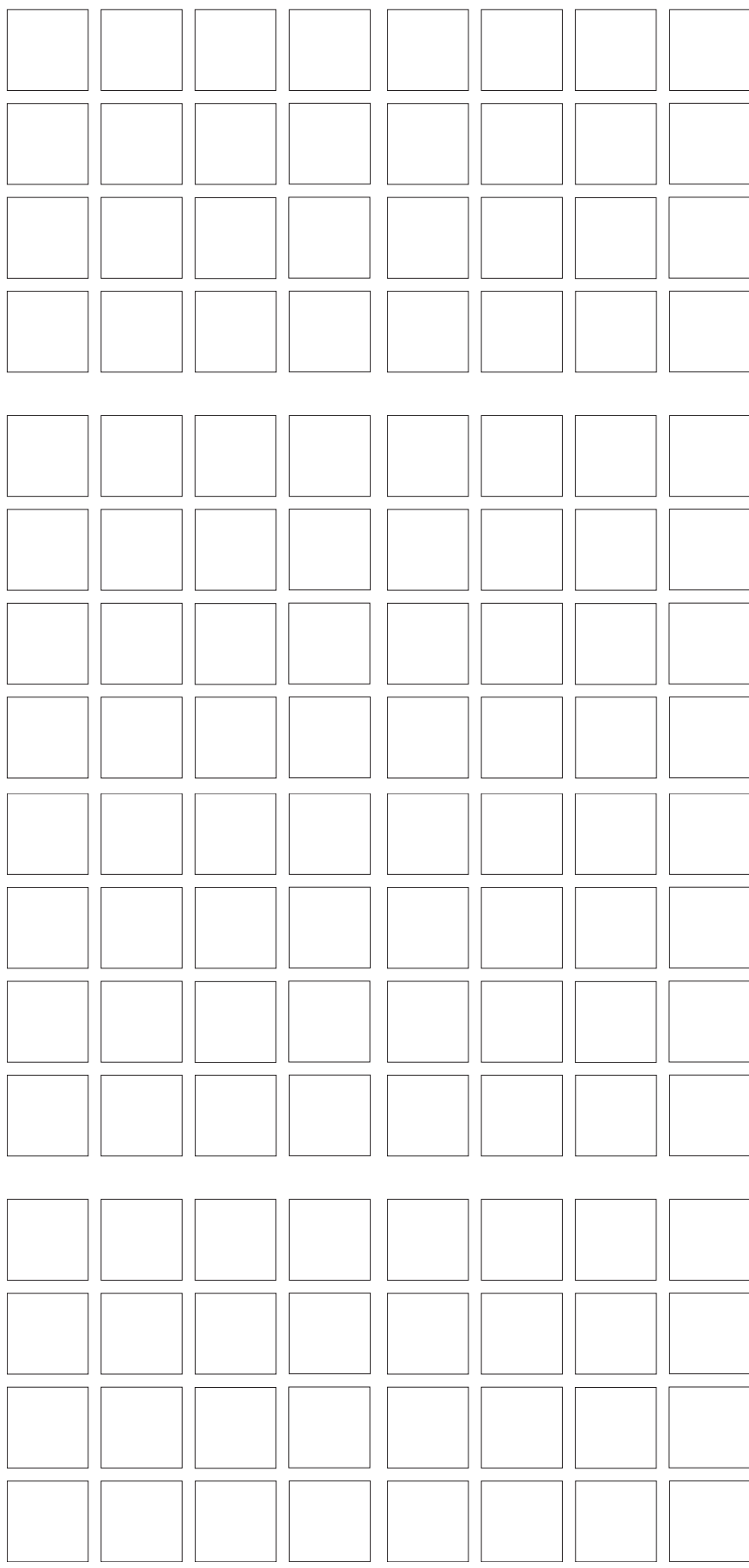


Figure 110. Button Label Blanks

# Extron Warranty

Extron Electronics warrants this product against defects in materials and workmanship for a period of three years from the date of purchase. In the event of malfunction during the warranty period attributable directly to faulty workmanship and/or materials, Extron Electronics will, at its option, repair or replace said products or components, to whatever extent it shall deem necessary to restore said product to proper operating condition, provided that it is returned within the warranty period, with proof of purchase and description of malfunction to:

**USA, Canada, South America, and Central America:**

Extron Electronics  
1230 South Lewis Street  
Anaheim, CA 92805  
U.S.A.

**Japan:**

Extron Electronics, Japan  
Kyodo Building, 16 Ichibancho  
Chiyoda-ku, Tokyo 102-0082  
Japan

**Europe and Africa:**

Extron Europe  
Hanzeboulevard 10  
3825 PH Amersfoort  
The Netherlands

**China:**

Extron China  
686 Ronghua Road  
Songjiang District  
Shanghai 201611  
China

**Asia:**

Extron Asia Pte Ltd  
135 Joo Seng Road, #04-01  
PM Industrial Bldg.  
Singapore 368363  
Singapore

**Middle East:**

Extron Middle East  
Dubai Airport Free Zone  
F12, PO Box 293666  
United Arab Emirates, Dubai

This Limited Warranty does not apply if the fault has been caused by misuse, improper handling care, electrical or mechanical abuse, abnormal operating conditions, or if modifications were made to the product that were not authorized by Extron.

**NOTE:** If a product is defective, please call Extron and ask for an Application Engineer to receive an RA (Return Authorization) number. This will begin the repair process.

**USA:** 714.491.1500 or 800.633.9876  
**Asia:** 65.6383.4400

**Europe:** 31.33.453.4040  
**Japan:** 81.3.3511.7655

Units must be returned insured, with shipping charges prepaid. If not insured, you assume the risk of loss or damage during shipment. Returned units must include the serial number and a description of the problem, as well as the name of the person to contact in case there are any questions.

Extron Electronics makes no further warranties either expressed or implied with respect to the product and its quality, performance, merchantability, or fitness for any particular use. In no event will Extron Electronics be liable for direct, indirect, or consequential damages resulting from any defect in this product even if Extron Electronics has been advised of such damage.

Please note that laws vary from state to state and country to country, and that some provisions of this warranty may not apply to you.

<b>Extron Headquarters</b> +1.800.633.9876 (Inside USA/Canada Only) Extron USA - West +1.714.491.1500 +1.714.491.1517 FAX	<b>Extron Europe</b> +800.3987.6673 (Inside Europe Only) +31.33.453.4040 +31.33.453.4050 FAX	<b>Extron Asia</b> +65.6383.4400 +65.6383.4664 FAX	<b>Extron Japan</b> +81.3.3511.7655 +81.3.3511.7656 FAX	<b>Extron China</b> +86.21.3760.1568 +86.21.3760.1566 FAX	<b>Extron Middle East</b> +971.4.299.1800 +971.4.299.1880 FAX	<b>Extron Korea</b> +82.2.3444.1571 +82.2.3444.1575 FAX	<b>Extron India</b> 1800.3070.3777 (Inside India Only) +91.80.3055.3777 +91.80.3055.3737 FAX
---	--	--	---	---	---	---	--